

# • Product Catalog •



Fiber optic • RG Cable • HDMI • UTP • Rack and Cabinet • SFP/Media Converter  
PoE/Industrial Switch • Surge Protection • Power Supply • Tool and Tester • OLT-ONU • Cable Tray



## • Product Partner



## • ที่ตั้งสำนักงานใหญ่ และ คลังสินค้า

**บริษัท โฟคอมม์ (ประเทศไทย) จำกัด**

**12 ซอย สุขุมวิท 5 ซอย 5 แยก 3 แขวง ท่าแร่ เขตบางเขน กรุงเทพมหานคร 10220**

TEL : 02-557-6451 / 063-391-5262

FAX : 02-557-6452

[www.focomm-cabling.com](http://www.focomm-cabling.com)

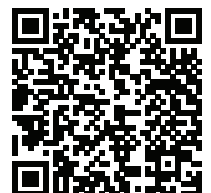

Download Catalog



## ABOUT US

บริษัท โฟคอมม์ (ประเทศไทย) จำกัด จดทะเบียนจัดตั้งเมื่อวันที่ 24 มีนาคม 2559 โดยมีวัตถุประสงค์เพื่อมุ่งเน้นธุรกิจขายสายสัญญาณคอมพิวเตอร์ ( Network Cabling ) โดย ท่านประธานบริษัท คุณ ณัฐพล วลัยวิทย์ อดีตเคยทำงานจำหน่ายสินค้าประเภทโครงข่ายสายนำสัญญาณ ในกลุ่มผลิตภัณฑ์ของ อเมริกา และ ยุโรป มามากกว่า 15 ปี จึงมีความคิดที่จะทำ แปรนสินค้า ที่มีคุณภาพดีเทียบเท่า อเมริกา และยุโรป จึงเป็นที่มาของแบรนด์ FOCOMM โดยทางบริษัทได้จดทะเบียนการค้าถูกต้องตามกฎหมาย เป้าหมายของทาง บริษัทฯ คือ การมุ่งเน้นคุณภาพสินค้าและราคาที่เหมาะสม ซึ่งสินค้าและบริการเรามีดังนี้

## PRODUCT

1. FIBER OPTIC PRODUCT
2. UTP PRODUCT
3. RG CABLE PRODUCT
4. HDMI PRODUCT
5. MEDIA CONVERTER
6. POE SWITCH
7. INDUSTRIAL SWITCH
8. POWER SUPPLY
9. TOOL AND TESTER
10. RACK AND CABINET
11. SURGE PROTECTION
12. OLT-ONU PRODUCT
13. CABLE TRAY

### วิสัยทัศน์ทางด้านพัฒนาบุคลากร

เนื่องจากสินค้าที่บริษัทฯ จัดจำหน่ายเป็นสินค้าด้านวิศวกรรม ทางบริษัทจึงมุ่งเน้นพัฒนา บุคลากรของบริษัทอยู่ตลอดเวลา และ มุ่งเน้นการให้ความรู้กับผู้ที่สนใจ โดยการจัดอบรมและสัมมนา ทั่วประเทศไทยตลอดทั้งปี

### วิสัยทัศน์ทางด้านพัฒนาสินค้า

ทางบริษัทฯ ถือหลักว่าสินค้าที่จัดจำหน่ายต้องมีคุณภาพสูง และ ราคาที่เหมาะสม โดยมีการรับประกันสินค้าที่คุ้มค่าเกินราคา รวมทั้งมีการทดสอบสินค้าก่อนจัดจำหน่าย รวมถึงมีทีม R&D ที่จะช่วยพัฒนาสินค้าให้กับทีมงาน

### วิสัยทัศน์ทางการขายและช่องทางการขาย

เน้นขายผ่านทาง ผู้รับเหมาโดยตรงและขายผ่านทางตัวแทนขาย เท่านั้น โดยการซื้อสามารถติดต่อผ่านมาที่บริษัทได้หลายช่องทาง เช่น ผ่านเซลล์ที่ดูแล หรือ ช่องทาง Online ต่างๆ โดยทางบริษัทฯ จะมีโปรแกรมส่งเสริมการขายออกมาในทุกๆ ไตรมาสของทุกปี

### วิสัยทัศน์ทางด้านบริการ

ทางบริษัทมุ่งเน้นการบริการ เพื่อให้ลูกค้าได้รับความพึงพอใจสูงสุด มีโปรแกรมการจัดส่งฟรีทั่วประเทศ (ตามยอดที่กำหนด) และการให้บริการทางด้านเซอร์วิส เรามีแผนกทดสอบสายสัญญาณ และติดตั้งอุปกรณ์ ไร้คอยบริการ

### วิสัยทัศน์ทางด้านเพื่อสังคม

ทางบริษัทจะมีการทำกิจกรรมเพื่อสังคมต่างๆในทุกๆเดือน เพื่อให้ทางลูกค้าได้มีส่วนร่วมในการคืนกำไรให้สังคม โดยสามารถเช็คข่าวสารต่างๆ ได้ทาง เว็บไซต์ ของทางบริษัทฯ หรือ สอบถามได้โดยตรงกับทางบริษัทฯ

โดย ทางบริษัทฯ สัญญาว่าจะ ผลิตสินค้าที่มีคุณภาพมาเพื่อจัดจำหน่าย และ บริการที่ประทับใจ ให้กับลูกค้าทุกท่าน



Thank you for using FOCOMM

V. Nattapol

Mr. Nattapol Valaiwit  
CEO of FOCOMM



# Index

---

**Page No.**



**Fiber Optic ..... 1-18**



**FTTH (Fiber Optic To The Home) ..... 19-26**



**MPO Solution for Data Center ..... 27-30**



**Air Blown Fiber ..... 31-34**



**RG Cable Product ..... 35-38**



**HDMI Product ..... 39-42**



**UTP Cable Product ..... 43-54**



**Rack And Cabinet ..... 55-72**



**SFP / Media Converter ..... 73-86**



**PoE Switch Product ..... 87-94**



**Surge Protection Product ..... 95-98**



**Power Supply Product ..... 99-102**



**Fiber Tool and Tester ..... 103-108**



**OLT-ONU Product ..... 109-118**



**Wire Mesh / Fiber Way ..... 119-122**



**Service ..... 123-124**



**IDEA ..... 125-132**

# Easy To Buy



## เลือกรายการสินค้า

- ▶ ได้ที่ Website Website : [www.focomm-cabling.com](http://www.focomm-cabling.com) หรือภายใน Catalog
- จำหน่ายอุปกรณ์ Network Cabling เช่น สายFiber Optic  
สายUTP ตู้Rack หรือ POE Switch เป็นต้น



## ติดต่อเราเพื่อกำการสั่งซื้อ

- ▶ ผ่านทางโทรศัพท์ Line หรือ Facebook สามารถสั่งซื้อสินค้าได้ในเวลาทำการ 8.00 - 18.00 น. ผ่านช่องทางง่าย ๆ

Tel : 06-3391-5262  
ID LINE@ : @focomm  
Facebook : focomm cabling  
Email : [info@focomm-cabling.com](mailto:info@focomm-cabling.com)



Facebook Fanpage



(ฝ่ายขาย)

## การชำระเงิน



- ชื่อบัญชี บริษัท โฟคอมม์ (ประเทศไทย) จำกัด สาขา บิ๊กซี สุขาภิบาล5
- ▶ ธนาคารไทยพาณิชย์ เลขที่บัญชี 406-926762-7
  - ▶ ธนาคารกสิกรไทย เลขที่บัญชี 011-3-69171-7



## บริการจัดส่งสินค้า



- ▶ ค่าบริการจัดส่งสินค้าต่างจังหวัด ยอดสั่งซื้อขั้นต่ำ 10,000 บาทขึ้นไป  
จัดส่งฟรีระยะเวลาการจัดส่ง 5 - 7 วันทำการ
- ยอดสั่งซื้อขั้นต่ำ 3,000 บาทบริการจัดส่งฟรี (เฉพาะเขตกรุงเทพและปริมณฑล)

## บริการหลังการขาย



- ▶ การรับประกัน สินค้าทุกรายการจะต้องเกิดความบกพร่องของตัวสินค้า  
ลูกค้าสามารถส่งคืนสินค้าได้ทันที ตรวจสอบสถานะของสินค้า ทั้งการจัดส่งและส่งคืน ได้ที่

Tel : 06-3391-5262  
ID LINE@ : @focomm  
Facebook : focomm cabling  
Email : [info@focomm-cabling.com](mailto:info@focomm-cabling.com)



Customer Service



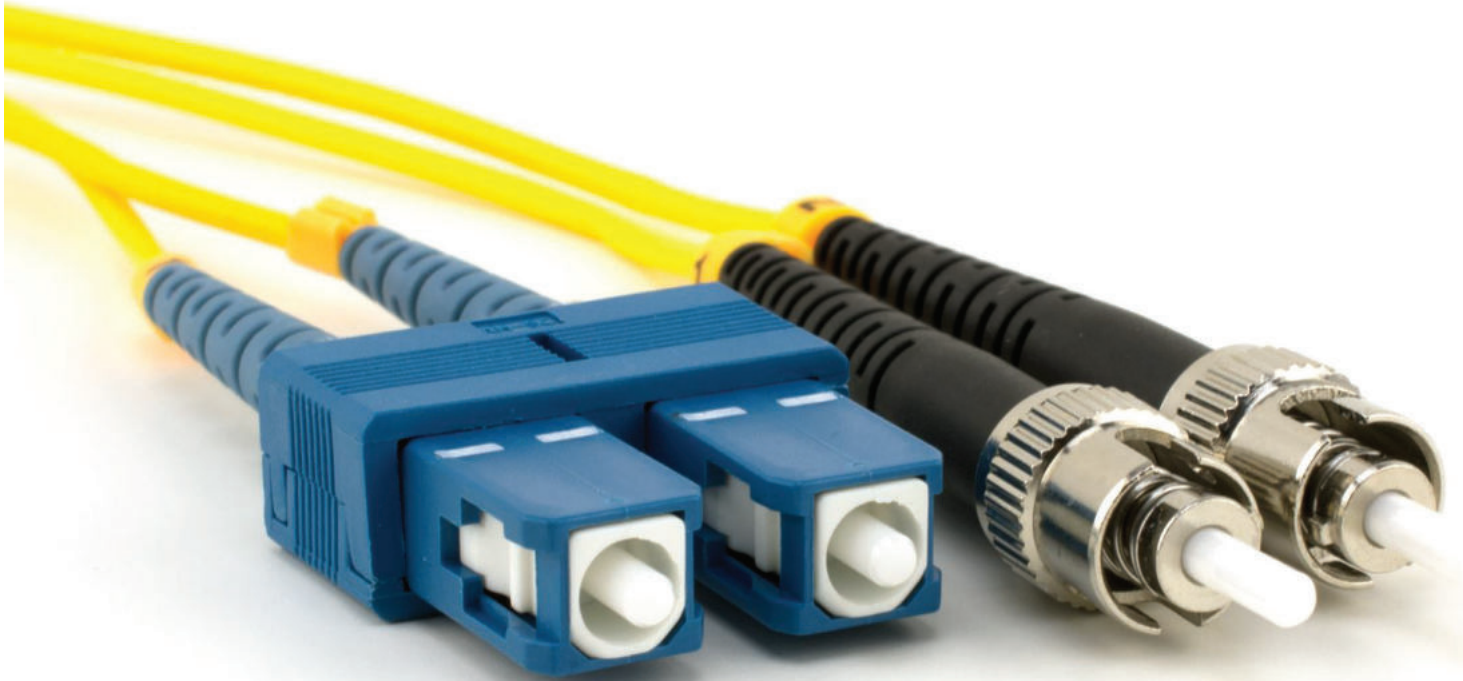

# Fiber Optic Product

- Fiber Optic Cable
- ADSS, ARSS
- Patch Cord and Pigtail
- Connector and Adapter
- Fiber Optic Distribution Panel (FDU)
- Fiber Enclosure



## Indoor Cable

### Zipcord

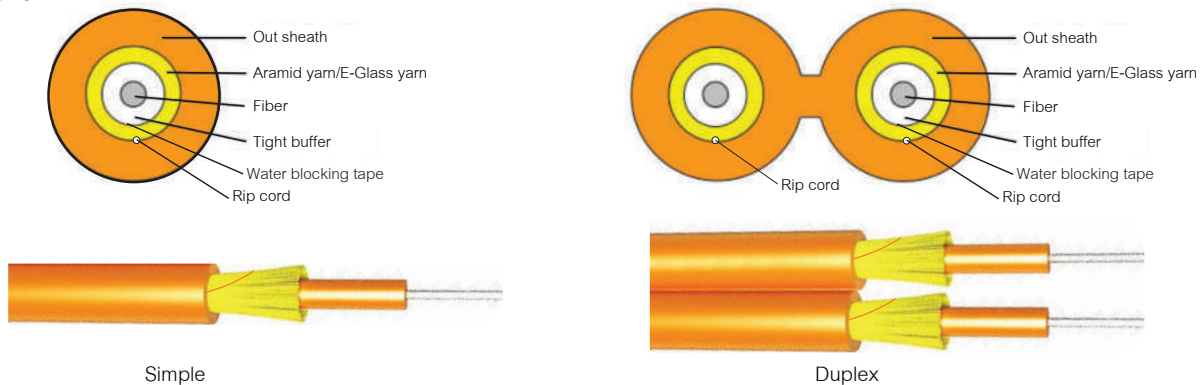

Simple

Duplex

### CHARACTERISTIC

- High strength aramid yarn strength member ensures high tensile strength and long term stability transmission
- Small outer diameter, lightweight, flame retardant, easy to strip, low attenuation, physically soft
- Direct splicing between tight buffer cables and need no tie-in box or pigtail

### STANDARD

ANSI/TIA-568-C.3, ANSI/TIA/EIA-568-B.3 ISO/IEC 11801:2002 , Telcordia (Bellcore) GR-409-CORE, ITU-T G.652D (Singlemode), ITU-T G.651 (Multimode), IEC 60332-1, IEC 60332-2& IEC 60332-3, IEC 60793/60794, ANSI/ICEA 596,EIA/TIA-455, UL Listed E337497 RoHS Compliant 2002/95/EC

### APPLICATION

- As building to building connecting cable
- As indoor soft cable along the wall, ceiling, between layers and in conduits
- As pigtails, movable connectors and patch cords for communication equipment
- Temperature range -40 °C ~ + 70 °C

### Distribution (Riser)

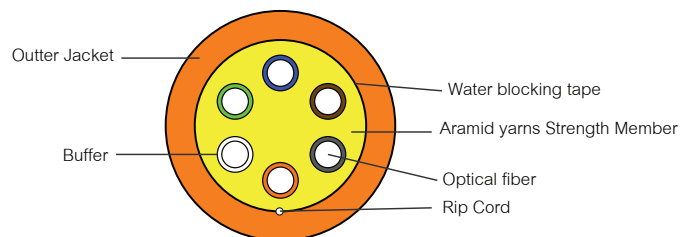
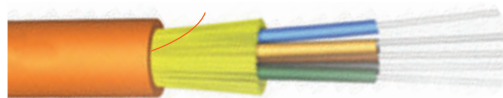

### CHARACTERISTIC

- High strength aramid yarn strength member ensures high tensile strength and long term stability transmission
- Small outer diameter, lightweight, flame retardant, easy to strip, low attenuation, physically soft
- Direct splicing between tight buffer cables and need no tie-in box or pigtail

### STANDARD

ISO/IEC 11801;2002, ANSI/TIA/EIA-568-B.3, ANSI/TIA-C.3,TELCORDIA 9 BELLCORE0 GR-409-CORE, ANSI/ICEA 596. ITU-T G.652D, IEC 60332-3, IEC 60794-1-2, EIA-455, UL, ROHS COMPLIMENT

### APPLICATION

- support IEEE802.3, ATM, FDDI, fiber channel, CATV,CCTV, FTTH or other
- As indoor soft cable along the wall, ceiling, between layers and in conduits
- As pigtails, movable connectors and patch cords for communication equipment
- Temperature range -40 °C ~ + 70 °C
- Max Tensile Load/Installation (1800N/600N)

### ORDERING TABLE

PRODUCT	PARTNUMBER	DESCRIPTION	PRICE
Zipcord	F-Z9-01-SX	Indoor Cable, Simple, SM, 1Core	4.00
	F-Z9-02-DX	Indoor Cable, Duplex, SM , 2Core	12.00
	F-Z5-01-SX	Indoor Cable, Simple, 50/125MM 1Core	6.00
	F-Z5-02-DX	Indoor Cable, Duplex, 50/125MM 2Core	14.00
Distribution (Riser)	F-D9-06	Distribution Cable 6 Core, SM	20.00
	F-D9-12	Distribution Cable 12 Core, SM	30.00
	F-D5-06	Distribution Cable 6 Core, 50/125MM	35.00
	F-D5-12	Distribution Cable 12 Core, 50/125MM	60.00

## TISI-2165

### Duct (Single Loose Tube) Indoor/Outdoor

#### Single Loose Tube Indoor/Outdoor (All Directic)

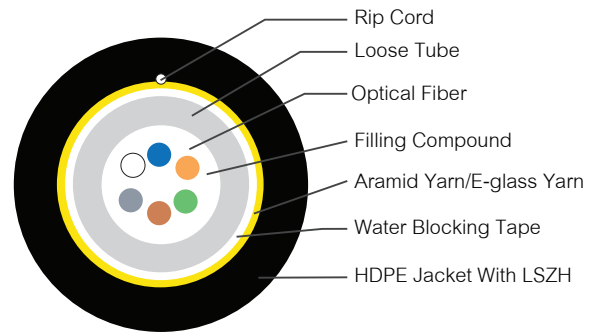

#### PROPERTIES

- Low attenuation, dispersion and special control of excess fiber length ensure excellent mechanical and envelopment properties.
- Filling compound and water block material validly prevent water penetration.
- Max Tensile Load/Installation (2700N/600N)

#### STANDARD

ANSI/TIA-568-C.3, ANSI/TIA/EIA-568-B.3, ISO/IEC 11801:2002 ,  
Telcordia(Bellcore) GR-409-CORE, ITU-T G.652D (Singlemode),  
ITU-T G.651 (Multimode), IEC 60332-1, IEC 60332-2& IEC 60332-3,  
IEC 60793/60794, ANSI/ICEA 596,EIA/TIA-455, UL Listed E337497,  
RoHS Compliant 2002/95/EC

#### APPLICATION

- Optical transmission cables for transmission equipment, data processing equipment, also suitable for general cabling.
- Laying method : Conduit, aerial, direct buried, shelf
- Temperature range -40 °C -+70 °C

#### Single Loose Tube Outdoor (Armored)

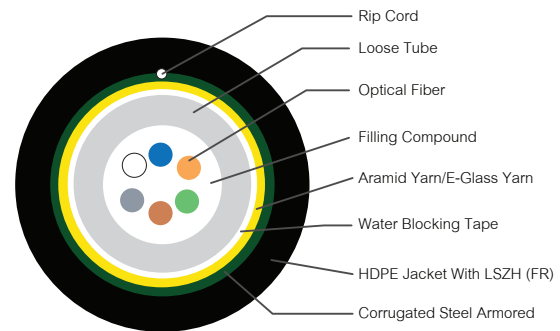

#### PROPERTIES

- Low attenuation, dispersion and special control of excess fiber length ensure excellent mechanical and environment properties.
- Filling compound validity prevent water penetration
- Aramid yarn/E-glass yarn increase the tensile strength of cable
- Small outer diameter, lightness and refined structure
- Max Tensile Load/Installation (2700N/1000N)

#### STANDARD

TIA/EIA-598-A ,IEEE802.3 (LAN, Ethernet Fast Ethernet, Gigabit Ethernet and 10 Gigabit Ethernet) ATM, FDDI, FTTH, FiberChannel, CATV, Communication, ISO/IEC 11801, ANSI/ TIA-568, Telcordia GR-20CORE, ICEA696, IEC61034-2, IEC60754-2, ITU G.652D, RoHS

#### APPLICATION

Special design to use with. All dielectric construction, Multimode or single mode fiberoptic. Duct or Lash aerial install. IEEE802.3 (LAN, Ethernet and 10 Gigabit Ethernet) ATM, FDDI, CATV, FTTH, communication.

#### ORDERING TABLE

PRODUCT	PARTNUMBER	DESCRIPTION	PRICE
Single Loose Tube Indoor/Outdoor (All Directic)	F-SL-IO9-04	Indoor/Outdoor Cable, SM 9/125um 4 Core	13.00
	F-SL-IO9-06	Indoor/Outdoor Cable, SM 9/125um 6 Core	15.00
	F-SL-IO9-12	Indoor/Outdoor Cable, SM 9/125um 12 Core	20.00
	F-SL-IO5-04	Indoor/Outdoor Cable, MM 50/125um 4 Core	20.00
	F-SL-IO5-06	Indoor/Outdoor Cable, MM 50/125um 6 Core	25.00
	F-SL-IO5-12	Indoor/Outdoor Cable, MM 50/125um 12 Core	35.00
Single Loose Tube Outdoor (Armored)	F-SL-ODA9-04	Outdoor Cable, with Armored, SM 9/125um 4 Core	15.00
	F-SL-ODA9-06	Outdoor Cable, with Armored, SM 9/125um 6 Core	17.00
	F-SL-ODA9-12	Outdoor Cable, with Armored, SM 9/125um 12 Core	22.00
	F-SL-ODA5-04	Outdoor Cable, with Armored, MM 5/125um 4 Core	22.00
	F-SL-ODA5-06	Outdoor Cable, with Armored, MM 5/125um 6 Core	27.00
	F-SL-ODA5-12	Outdoor Cable, with Armored, MM 5/125um 12 Core	37.00



## TISI-2166

### Drop Wire Cable (Single Loose Tube)

#### Single Loose Tube Dropwire

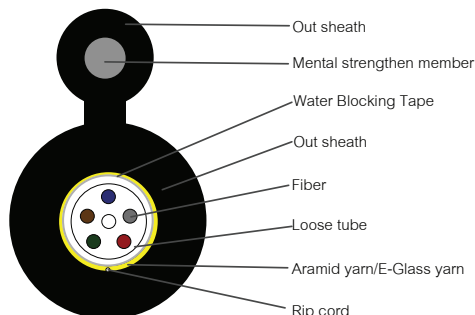
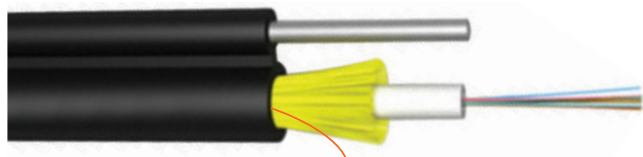

#### PROPERTIES

- Low attenuation, dispersion and special control of excess fiber length ensure excellent mechanical and envelopment properties.
- Filling compound and water block material validly prevent water penetration.
- Max Tensile Load/Installation (1600N/600N)

#### STANDARD

ISO/IEC 11801:2002, ANSI/TIA-568-C.3, ANSI/TIA/EIA-568-B.3, ANSI/ICEA 696, Telcordia GR-409-CORE, Telcordia GR-20-CORE, IEC 60793, IEC 60794-1-2, IEC 61034-2, IEC 60754-2, IEC 60332-3, IEC 60332-1, ITU-T G.652D (Single mode), ITU-T G.651 (Multimode), EN 50173-1, RoHS Compliant 2002/95/EC

#### APPLICATION

- Special design for used together with outdoor and indoor
- All dielectric construction
- Multi-mode or single-mode fiber optic
- ATM, FDDI, CATV, FTTX, communication

#### Single Loose Tube Dropwire Armored

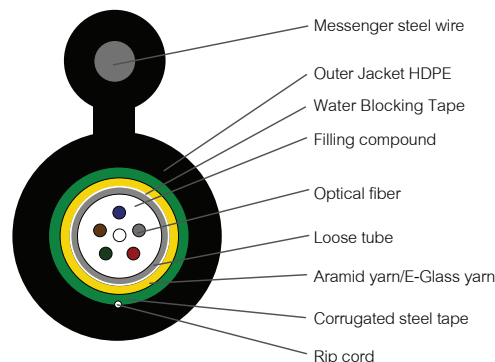
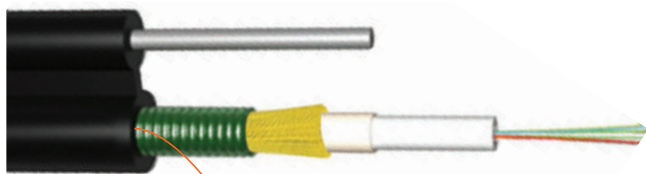

#### PROPERTIES

- Low attenuation, dispersion and special control of excess fiber length ensure excellent mechanical and envelopment properties.
- Filling compound and water block material validly prevent water penetration.
- Max Tensile Load/Installation (1500N/800N)

#### STANDARD

ISO/IEC 11801:2002, ANSI/TIA-568-C.3, ANSI/TIA/EIA-568-B.3, ANSI/ICEA 696, TIA/EIA-598-A, Telcordia GR-409-CORE, Telcordia GR-20-CORE, IEC 60793, IEC 60793-2, IEC 60794-1-2, IEC 61034-2, IEC 60754-2, IEC 60332-3, IEC 60332-1, ITU-T G.652D (Single mode), ITU-T G.651 (Multimode), EN 50173-1, RoHS Compliant 2002/95/EC

#### APPLICATION

- Special design for used together with outdoor and indoor
- All dielectric construction
- Muti-mode or single-mode fiber optic
- ATM, FDDI, CATV, FTTX, communication

#### ORDERING TABLE

PRODUCT	PARTNUMBER	DESCRIPTION	PRICE
Single Loose Tube Dropwire	F-SL-DW9-04	Outdoor Cable, Drop Wire, SM 9/125um 4 Core	13.00
	F-SL-DW9-06	Outdoor Cable, Drop Wire, SM 9/125um 6 Core	14.50
	F-SL-DW9-12	Outdoor Cable, Drop Wire, SM 9/125um 12 Core	17.00
Single Loose Tube Dropwire Armored	F-SL-DWA9-04	Outdoor Cable, Drop Wire, with Armored, SM 9/125um 4 Core	13.50
	F-SL-DWA9-06	Outdoor Cable, Drop Wire, with Armored, SM 9/125um 6 Core	15.00
	F-SL-DWA9-12	Outdoor Cable, Drop Wire, with Armored, SM 9/125um 12 Core	18.00

## TISI-2166

### Drop Wire Cable (Single Loose Tube) Fig-8

#### Single Loose Tube Fig-8 Armored

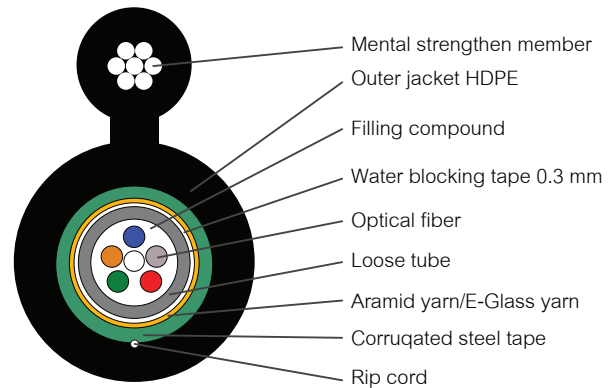
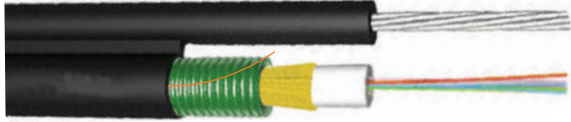

#### PROPERTIES

- Low attenuation, dispersion and special control of excess fiber length ensure excellent mechanical and envelopment properties.
- Filling compound and water block material validly prevent water penetration.
- Max Tensile Load/Installation (6000N/3000N)

#### APPLICATION

- Special design for used together with outdoor and indoor
- All dielectric construction
- Multi-mode or single-mode fiber optic
- ATM, FDDI, CATV, FTTX, communication

#### CHARACTERISTIC

- Suspension wire
- Aramid yarns/E-Glass yarn
- Filling compound
- Corrugated steel tape
- Optical fibers
- Outer jacket HDPE (LSZH) with rodent protection
- Rip cord
- Water blocking tape

#### STANDARD

ISO/IEC 11801:2002, ANSI/TIA-568-C.3, ANSI/TIA/EIA-568-B.3, TIA/EIA-598-A, ANSI/ICEA 696, Telcordia GR-409-CORE, Telcordia GR-20-CORE, IEC 60793, IEC 60794-1-2, IEC 61034-2, IEC 60754-2, IEC 60332-3, IEC 60332-1, ITU-T G.652D (Single mode), ITU-T G.651 (Multimode), EN 50173-1, RoHS Compliant 2002/95/EC

#### ORDERING TABLE

PRODUCT	PARTNUMBER	DESCRIPTION	PRICE
Single Loose Tube Fig.8 Armored	F-SL-F8A9-04	Outdoor Cable, Fig-8 (7*1mm), with Armored, SM 9/125um 4 Core	18.00
	F-SL-F8A9-06	Outdoor Cable, Fig-8 (7*1mm), with Armored, SM 9/125um 6 Core	20.00
	F-SL-F8A9-12	Outdoor Cable, Fig-8 (7*1mm), with Armored, SM 9/125um 12 Core	22.00

## TISI-2165

### Duct (Multi Loose Tube)

#### Outdoor Single Jacket

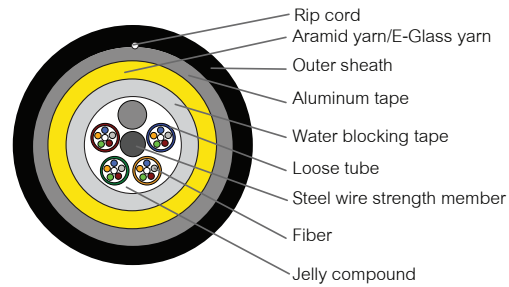
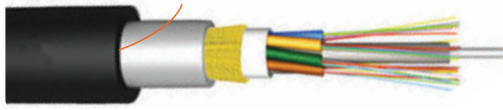

#### APPLICATION

- Special design for used together with outdoor and indoor
- All dielectric construction
- Duct or Lash Aerial install
- Multi-mode or single-mode fiber optic
- IEEE802.3 (LAN, Ethernet fast Ethernet)
- ATM, FDDI, CATV, FTTX, communication

#### STANDARD

ANSI/TIA-568-C.3, ANSI/TIA/EIA-568-B.3, ISO/IEC 11801:2002, Telcordia (Bellcore) GR-409-CORE, ITU-T G.652 (Singlemode), ITU-T G.651 (Multimode), IEC 60332-1, IEC 60332-2& IEC 60332-3, IEC 60793/60794, ANSI/ICEA 596, EIA/TIA-455, UL, RoHS Compliant 2002/95/EC

#### Outdoor Single Jacket Armored

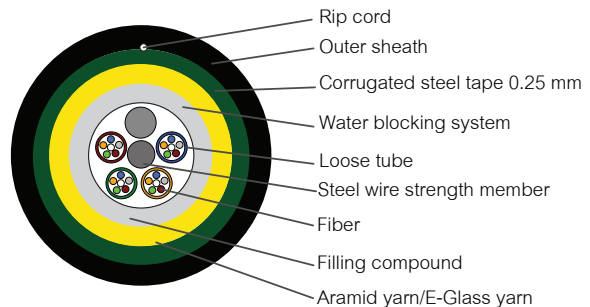
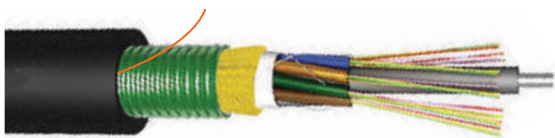

#### APPLICATION

- Special design for used together with outdoor and indoor
- All dielectric construction
- Duct or Lash Aerial install
- Multi-mode or single-mode fiber optic
- IEEE802.3 (LAN, Ethernet fast Ethernet)
- ATM, FDDI, CATV, FTTX, communication

#### STANDARD

ANSI/TIA-568-C.3, ANSI/TIA/EIA-568-B.3, ISO/IEC 11801:2002, Telcordia (Bellcore) GR-409-CORE, ITU-T G.652 (Singlemode), ITU-T G.651 (Multimode), IEC 60332-1, IEC 60332-2& IEC 60332-3, IEC 60793/60794, ANSI/ICEA 596, EIA/TIA-455, UL, RoHS Compliant 2002/95/EC

#### Outdoor Double Jacket Armored

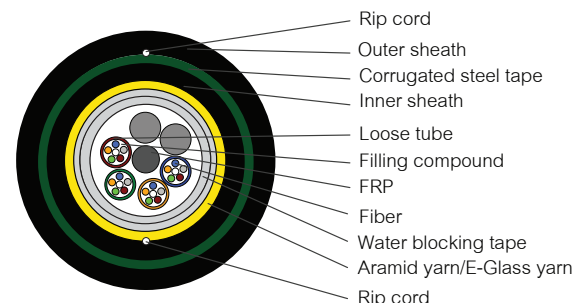
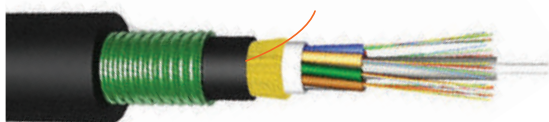

#### APPLICATION

- Special design for used together with outdoor and indoor
- All dielectric construction
- Duct or Lash Aerial install
- Multi-mode or single-mode fiber optic
- IEEE802.3 (LAN, Ethernet fast Ethernet)
- ATM, FDDI, CATV, FTTX, communication

#### STANDARD

ANSI/TIA-568-C.3, ANSI/TIA/EIA-568-B.3, ISO/IEC 11801:2002, Telcordia (Bellcore) GR-409-CORE, ITU-T G.652 (Singlemode), ITU-T G.651 (Multimode), IEC 60332-1, IEC 60332-2& IEC 60332-3, IEC 60793/60794, ANSI/ICEA 596, EIA/TIA-455, UL, RoHS Compliant 2002/95/EC

#### ORDERING TABLE

PRODUCT	PARTNUMBER	DESCRIPTION	PRICE
Outdoor Single Jacket	F-ML-OD9-12-SJ	Outdoor Cable, Multi Loose Tube, Single Jacket, SM 9/125 12Core	24.00
	F-ML-OD9-24-SJ	Outdoor Cable, Multi Loose Tube, Single Jacket, SM 9/125 24Core	35.00
	F-ML-OD9-48-SJ	Outdoor Cable, Multi Loose Tube, Single Jacket, SM 9/125 48Core	45.00
	F-ML-OD9-96-SJ	Outdoor Cable, Multi Loose Tube, Single Jacket, SM 9/125 96Core	70.00
Outdoor Single Jacket Armored	F-ML-ODA9-12-SJ	Outdoor Cable, Multi Loose Tube, Single Jacket, Armored, SM 9/125 12Core	25.00
	F-ML-ODA9-24-SJ	Outdoor Cable, Multi Loose Tube, Single Jacket, Armored, SM 9/125 24Core	37.00
	F-ML-ODA9-48-SJ	Outdoor Cable, Multi Loose Tube, Single Jacket, Armored, SM 9/125 48Core	48.00
	F-ML-ODA9-96-SJ	Outdoor Cable, Multi Loose Tube, Single Jacket, Armored, SM 9/125 96Core	74.00
Outdoor Double Jacket Armored	F-ML-ODA9-12-DJ	Outdoor Cable, Multi Loose Tube, Double Jacket, Armored, SM 9/125 12Core	27.00
	F-ML-ODA9-24-DJ	Outdoor Cable, Multi Loose Tube, Double Jacket, Armored, SM 9/125 24Core	40.00
	F-ML-ODA9-48-DJ	Outdoor Cable, Multi Loose Tube, Double Jacket, Armored, SM 9/125 48Core	50.00
	F-ML-ODA9-96-DJ	Outdoor Cable, Multi Loose Tube, Double Jacket, Armored, SM 9/125 96Core	80.00



## TISI-2166

### Drop Wire Cable (Multi Loose Tube)

#### Multi Loose Tube Dropwire

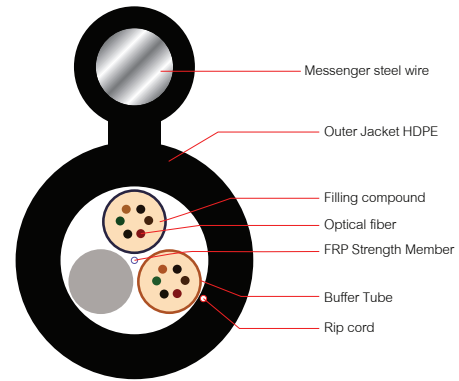

#### PROPERTIES

- Low attenuation, dispersion and special control of excess fiber length ensure excellent mechanical and envelopment properties.
- Filling compound and water block material validly prevent water penetration.

#### STANDARD

ISO/IEC 11801:2002, ANSI/TIA-568-C.3, ANSI/TIA/EIA-568-B.3, ANSI/ICEA 696, TIA/EIA-598-A, Telcordia GR-409-CORE, Telcordia(Bellcore) GR-20-CORE, IEC 60793-2B1.3, IEC 60793, IEC 60793-2, IEC 60794-1-2, IEC 61034-2, IEC 60754-2, IEC 60332-3, IEC 60332-1, ITU-T G.652D (Single mode), ITU-T G.651 (Multimode), EN 50173-1, RoHS Compliant 2002/95/EC, IEC 60793-2 B 1.3, TIS 2166-2548

#### APPLICATION

- Special design for used together with outdoor and indoor
- All dielectric construction
- Multi-mode or single-mode fiber optic
- ATM, FDDI, CATV, FTTX, communication

#### Multi Loose Tube Dropwire Armored

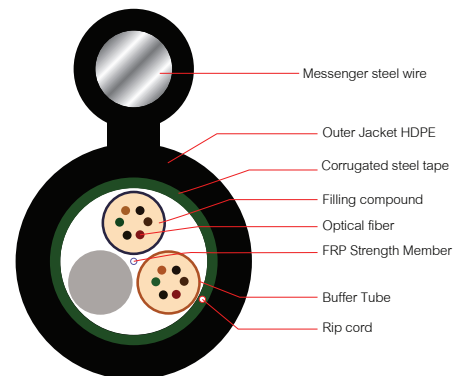

#### PROPERTIES

- Low attenuation, dispersion and special control of excess fiber length ensure excellent mechanical and envelopment properties.
- Filling compound and water block material validly prevent water penetration.

#### STANDARD

ISO/IEC 11801:2002, ANSI/TIA-568-C.3, ANSI/TIA/EIA-568-B.3, ANSI/ICEA 696, TIA/EIA-598-A, Telcordia GR-409-CORE, Telcordia(Bellcore) GR-20-CORE, IEC 60793-2B1.3, IEC 60793, IEC 60793-2, IEC 60794-1-2, IEC 61034-2, IEC 60754-2, IEC 60332-3, IEC 60332-1, ITU-T G.652D (Single mode), ITU-T G.651 (Multimode), EN 50173-1, RoHS Compliant 2002/95/EC, IEC 60793-2 B 1.3, TIS 2166-2548

#### APPLICATION

- Special design for used together with outdoor and indoor
- All dielectric construction
- Multi-mode or single-mode fiber optic
- ATM, FDDI, CATV, FTTX, communication

#### ORDERING TABLE

PRODUCT	PARTNUMBER	DESCRIPTION	PRICE
Multi Loose Tube Dropwire	F-ML-DW9-04	Outdoor Cable, Multi Loose Tube, Drop Wire, SM 9/125um 4 Core	15.00
	F-ML-DW9-06	Outdoor Cable, Multi Loose Tube, Drop Wire, SM 9/125um 6 Core	16.00
	F-ML-DW9-12	Outdoor Cable, Multi Loose Tube, Drop Wire, SM 9/125um 12 Core	20.00
Multi Loose Tube Dropwire Armored	F-ML-DWA9-04	Outdoor Cable, Multi Loose Tube, Drop Wire, with Armored, SM 9/125um 4 Core	16.00
	F-ML-DWA9-06	Outdoor Cable, Multi Loose Tube, Drop Wire, with Armored, SM 9/125um 6 Core	17.00
	F-ML-DWA9-12	Outdoor Cable, Multi Loose Tube, Drop Wire, with Armored, SM 9/125um 12 Core	22.00

### Drop Wire Cable (Multi Loose Tube) Fig-8

#### Multi loose tube Outdoor Fig-8

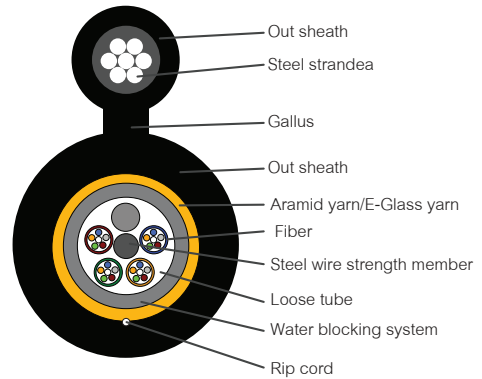
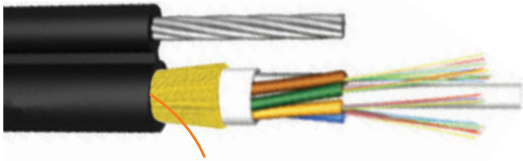

#### PROPERTIES

- Low attenuation, dispersion and special control of excess fiber length ensure excellent mechanical and envelopment properties.
- Filling compound and water block material validly prevent water penetration.
- Aramid yarns increase the tensile strength of cable
- Small outer diameter, lightness and refined structure
- Max Tensile Load/Installation (7000N/4000N)

#### APPLICATION

- Special design for used together with outdoor and indoor
- All dielectric construction
- Duct or Lash Aerial install
- Multi-mode or single-mode fiber optic
- IEEE802.3 (LAN, Ethernet fast Ethernet)
- ATM, FDDI, CATV, FTTX, Fiber Channel Communication

#### STANDARD

ANSI/TIA-568-C.3, ANSI/TIA/EIA-568-B.3, TIA/EIA-598-A, ISO/IEC 11801:2002, Telcordia (Bellcore) GR-409-CORE, ITU-T G.652 (Singlemode), ITU-T G.651 (Multimode), IEC 60332-1, IEC 60332-2& IEC 60332-3, IEC 60793/60794, ANSI/ICEA 596, EIA/TIA-455, ICEA 640, UL, RoHS Compliant 2002/95/EC

#### Multi loose tube Outdoor Fig-8 Armored

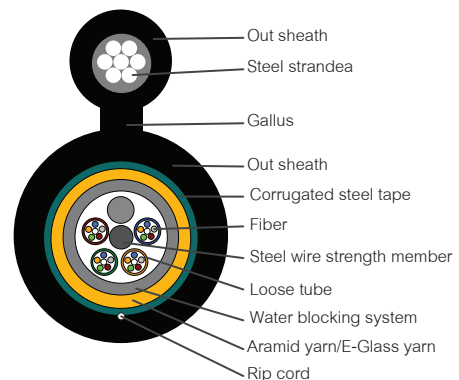
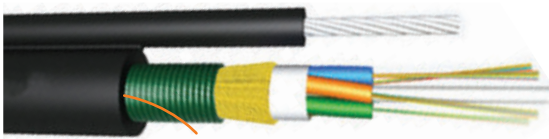

#### PROPERTIE

- Low attenuation, dispersion and special control of excess fiber length ensure excellent mechanical and envelopment properties.
- Filling compound and water block material validly prevent water penetration.
- Aramid yarns increase the tensile strength of cable
- Max Tensile Load/Installation (7000N/4000N)

#### APPLICATION

- Special design for used together with outdoor and indoor
- All dielectric construction
- Duct or Lash Aerial install
- Multi-mode or single-mode fiber optic
- IEEE802.3 (LAN, Ethernet fast Ethernet)
- ATM, FDDI, CATV, FTTX, communication

#### STANDARD

ANSI/TIA-568-C.3, ANSI/TIA/EIA-568-B.3, ISO/IEC 11801:2002, Telcordia (Bellcore) GR-409-CORE, ITU-T G.652 (Singlemode), ITU-T G.651 (Multimode), IEC 60332-1, IEC 60332-2& IEC 60332-3, IEC 60793/60794, ANSI/ICEA 596, EIA/TIA-455, UL, RoHS Compliant 2002/95/EC

#### ORDERING TABLE

PRODUCT	PARTNUMBER	DESCRIPTION	PRICE
Fig.8 Single Jacket	F-ML-F89-12-SJ	Outdoor Cable, Multi Loose Tube, Fig.8, Single Jacket, SM 9/125 12Core	24.00
	F-ML-F89-24-SJ	Outdoor Cable, Multi Loose Tube, Fig.8, Single Jacket, SM 9/125 24Core	35.00
	F-ML-F89-48-SJ	Outdoor Cable, Multi Loose Tube, Fig.8, Single Jacket, SM 9/125 48Core	45.00
	F-ML-F89-96-SJ	Outdoor Cable, Multi Loose Tube, Fig.8, Single Jacket, SM 9/125 96 Core	70.00
Fig.8 Single Jacket Armored	F-ML-F8A9-12-SJ	Outdoor Cable, Multi Loose Tube, Fig.8, Single Jacket, Armored, SM 9/125 12Core	25.00
	F-ML-F8A9-24-SJ	Outdoor Cable, Multi Loose Tube, Fig.8, Single Jacket, Armored, SM 9/125 24Core	37.00
	F-ML-F8A9-48-SJ	Outdoor Cable, Multi Loose Tube, Fig.8, Single Jacket, Armored, SM 9/125 48Core	48.00
	F-ML-F8A9-96-SJ	Outdoor Cable, Multi Loose Tube, Fig.8, Single Jacket, Armored, SM 9/125 96Core	74.00

## TISI-2165

### ADSS Cable

#### Mini ADSS Single Jacket Cable

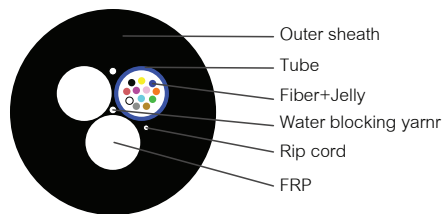

#### PRODUCT DESCRIPTION

- Provide additional mechanical protection
- low friction installation
- Excellent protection from environmental hazards
- Max Tensile Load/Installation (1200N)

#### APPLICATION

Environment with high electric field strength in the Power communication system and the area where frequent thunder happens.

#### ADSS Single Jacket Cable

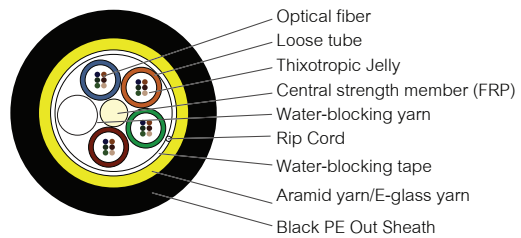
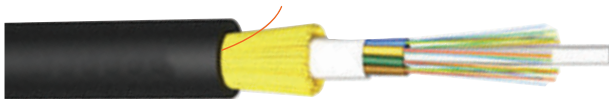

#### PRODUCT DESCRIPTION

- Provide additional mechanical protection
- low friction installation
- Excellent protection from environmental hazards
- Max Tensile Load/Installation (3600N/1800N)

#### APPLICATION

Environment with high electric field strength in the Power communication system and the area where frequent thunder happens.

#### ADSS Double Jacket Cable

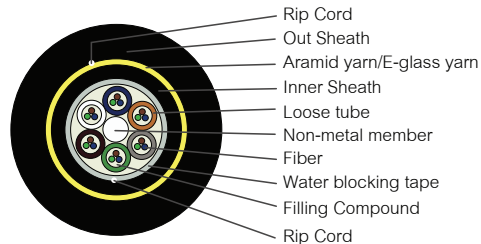
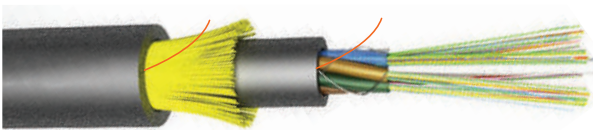

#### PRODUCT DESCRIPTION

- Provide additional mechanical protection
- low friction installation
- Excellent protection from environmental hazards
- Max Tensile Load/Installation (5000N/2500N)

#### APPLICATION

Environment with high electric field strength in the Power communication system and the area where frequent thunder happens.

#### STANDARD

TIA/EIA-598-A ,IEEE802.3 (LAN, Ethernet Fast Ethernet, Gigabit Ethernet and 10 Gigabit Ethernet) ATM, FDDI, FTTX, Fiber Channel, CATV, Communication, ISO/IEC 11801, ANSI/ TIA-568, Telcordia GR-20CORE, ICEA696, IEC61034-2, IEC60754-2, ITU G.652D, RoHS.

#### ORDERING TABLE

PRODUCT	PARTNUMBER	DESCRIPTION	PRICE
Mini ADSS Single Jacket Cable	F-MN-ADSS9-06-SJ	Outdoor Cable, Multi Loose Tube, Mini ADSS, Single Jacket, SM 9/125 6 Core	16.00
	F-MN-ADSS9-12-SJ	Outdoor Cable, Multi Loose Tube, Mini ADSS, Single Jacket, SM 9/125 12 Core	20.00
	F-MN-ADSS9-24-SJ	Outdoor Cable, Multi Loose Tube, Mini ADSS, Single Jacket, SM 9/125 24 Core	28.00
ADSS Single Jacket Cable	F-ML-ADSS9-06-SJ	Outdoor Cable, Multi Loose Tube, ADSS, Single Jacket, SM 9/125 6 Core	20.00
	F-ML-ADSS9-12-SJ	Outdoor Cable, Multi Loose Tube, ADSS, Single Jacket, SM 9/125 12 Core	22.00
	F-ML-ADSS9-24-SJ	Outdoor Cable, Multi Loose Tube, ADSS, Single Jacket, SM 9/125 24 Core	30.00
	F-ML-ADSS9-48-SJ	Outdoor Cable, Multi Loose Tube, ADSS, Single Jacket, SM 9/125 48 Core	45.00
	F-ML-ADSS9-96-SJ	Outdoor Cable, Multi Loose Tube, ADSS, Single Jacket, SM 9/125 96 Core	80.00
	F-ML-ADSS9-120-SJ	Outdoor Cable, Multi Loose Tube, ADSS, Single Jacket, SM 9/125 120 Core	100.00
ADSS Double Jacket Cable	F-ML-ADSS9-06-DJ	Outdoor Cable, Multi Loose Tube, ADSS, Double Jacket, SM 9/125 6 Core	23.00
	F-ML-ADSS9-12-DJ	Outdoor Cable, Multi Loose Tube, ADSS, Double Jacket, SM 9/125 12 Core	27.00
	F-ML-ADSS9-24-DJ	Outdoor Cable, Multi Loose Tube, ADSS, Double Jacket, SM 9/125 24 Core	35.00
	F-ML-ADSS9-48-DJ	Outdoor Cable, Multi Loose Tube, ADSS, Double Jacket, SM 9/125 48 Core	50.00
	F-ML-ADSS9-96-DJ	Outdoor Cable, Multi Loose Tube, ADSS, Double Jacket, SM 9/125 96 Core	85.00
	F-ML-ADSS9-120-DJ	Outdoor Cable, Multi Loose Tube, ADSS, Double Jacket, SM 9/125 120 Core	105.00



## TISI-2165

### ARSS Cable

#### ARSS Cable with FRP Armored

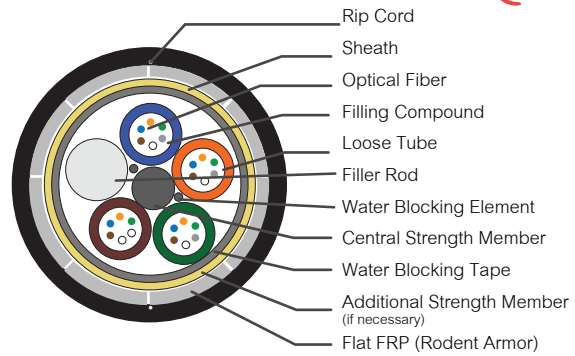

#### PRODUCT DESCRIPTION

- Provide additional mechanical protection
- low friction installation
- Excellent protection from environmental hazards
- Max Tensile Load/Installation (3600N/1800N)

#### APPLICATION

Environment with high electric field strength in the Power communication system and the area where frequent thunder happens.

#### STANDARD

TIA/EIA-598-A ,IEEE802.3 (LAN, Ethernet Fast Ethernet, Gigabit Ethernet and 10 Gigabit Ethernet) ATM, FDDI, FTTX, Fiber Channel, CATV, Communication, ISO/IEC 11801, ANSI/ TIA-568, Telcordia GR-20CORE, ICEA696, IEC61034-2, IEC60754-2, ITU G.652D, RoHS.

#### ARSS Double Jacket Cable

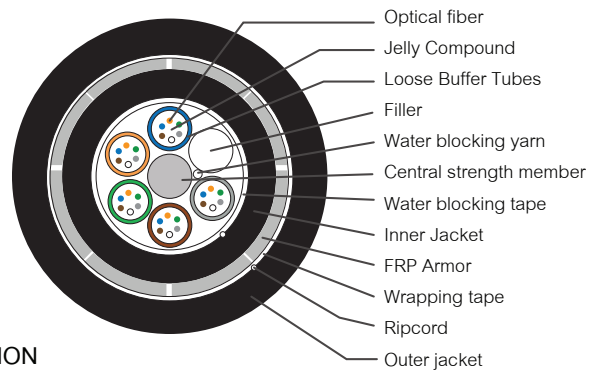

#### PRODUCT DESCRIPTION

- Provide additional mechanical protection
- low friction installation
- Excellent protection from environmental hazards
- Max Tensile Load/Installation (7000N/3600N)

#### APPLICATION

Environment with high electric field strength in the Power communication system and the area where frequent thunder happens.

#### STANDARD

TIA/EIA-598-A ,IEEE802.3 (LAN, Ethernet Fast Ethernet, Gigabit Ethernet and 10 Gigabit Ethernet) ATM, FDDI, FTTX, Fiber Channel, CATV, Communication, ISO/IEC 11801, ANSI/ TIA-568, Telcordia GR-20CORE, ICEA696, IEC61034-2, IEC60754-2, ITU G.652D, RoHS.

#### ORDERING TABLE

PRODUCT	PARTNUMBER	DESCRIPTION	PRICE
ARSS Cable with FRP Armored	F-ML-ARSS9-06-SJ	Outdoor Cable, Multi Loose Tube, ARSS, Single Jacket, SM 9/125 06 Core	25.00
	F-ML-ARSS9-12-SJ	Outdoor Cable, Multi Loose Tube, ARSS, Single Jacket, SM 9/125 12 Core	30.00
	F-ML-ARSS9-24-SJ	Outdoor Cable, Multi Loose Tube, ARSS, Single Jacket, SM 9/125 24 Core	40.00
	F-ML-ARSS9-48-SJ	Outdoor Cable, Multi Loose Tube, ARSS, Single Jacket, SM 9/125 48 Core	55.00
	F-ML-ARSS9-96-SJ	Outdoor Cable, Multi Loose Tube, ARSS, Single Jacket, SM 9/125 96 Core	90.00
ARSS Double Jacket Cable	F-ML-ARSS9-06-DJ	Outdoor Cable, Multi Loose Tube, ARSS, Double Jacket, SM 9/125 06 Core	30.00
	F-ML-ARSS9-12-DJ	Outdoor Cable, Multi Loose Tube, ARSS, Double Jacket, SM 9/125 12 Core	35.00
	F-ML-ARSS9-24-DJ	Outdoor Cable, Multi Loose Tube, ARSS, Double Jacket, SM 9/125 24 Core	45.00
	F-ML-ARSS9-48-DJ	Outdoor Cable, Multi Loose Tube, ARSS, Double Jacket, SM 9/125 48 Core	60.00
	F-ML-ARSS9-96-DJ	Outdoor Cable, Multi Loose Tube, ARSS, Double Jacket, SM 9/125 96 Core	100.00

## PIGTAIL SM,MM / PIGTAIL Armored SM,MM



### DESCRIPTION

The FOCOMM offers a comprehensive line of fiber jumpers for connecting fiber links. Choose from simplex or duplex, multimode (62.5/125 or 50/125) or single mode, SC or ST, jumpers, or pigtails. Assemblies are available in standard lengths of 1, 2, 3, and 5 meters, (custom lengths are also available). Each and every terminated connector is optically tested so that you can be assured that 100% of the FOCOMM-built cable assemblies meet the stringent performance limits as noted in the specifications chart. All jumpers are manufactured using the finest quality connectors and OFNR riser grade fiber.

### ORDERING INFORMATION

PRODUCT	PARTNUMBER	DESCRIPTION	PRICE
SM	F-PT-ST9-0.9mm/2mm	Pigtail ST, SM 9/125um (900um Jacket)/ (2mm Jacket)	60.00
	F-PT-SC9-0.9mm/2mm	Pigtail SC, SM 9/125um (900um Jacket)/ (2mm Jacket)	60.00
	F-PT-LC9-0.9mm/2mm	Pigtail LC, SM 9/125um (900um Jacket)/ (2mm Jacket)	60.00
	F-PT-FC9-0.9mm/2mm	Pigtail FC, SM 9/125um (900um Jacket)/ (2mm Jacket)	60.00
MM	F-PT-ST5-0.9mm/2mm	Pigtail ST, MM 50/125um (900um Jacket)/ (2mm Jacket)	60.00
	F-PT-SC5-0.9mm/2mm	Pigtail SC, MM 50/125um (900um Jacket)/ (2mm Jacket)	60.00
	F-PT-LC5-0.9mm/2mm	Pigtail LC, MM 50/125um (900um Jacket)/ (2mm Jacket)	60.00
	F-PT-FC5-0.9mm/2mm	Pigtail FC, MM 50/125um (900um Jacket)/ (2mm Jacket)	60.00
SM Armored	F-PTA-ST9-0.9mm/2mm	Pigtail Armored ST, SM 9/125um (900um Jacket)/ (2mm Jacket)	80.00
	F-PTA-SC9-0.9mm/2mm	Pigtail Armored SC, SM 9/125um (900um Jacket)/ (2mm Jacket)	80.00
	F-PTA-LC9-0.9mm/2mm	Pigtail Armored LC, SM 9/125um (900um Jacket)/ (2mm Jacket)	80.00
	F-PTA-FC9-0.9mm/2mm	Pigtail Armored FC, SM 9/125um (900um Jacket)/ (2mm Jacket)	80.00
	F-PTA-ST5-0.9mm/2mm	Pigtail Armored ST, MM 50/125um (900um Jacket)/ (2mm Jacket)	80.00
MM Armored	F-PTA-SC5-0.9mm/2mm	Pigtail Armored SC, MM 50/125um (900um Jacket)/ (2mm Jacket)	80.00
	F-PTA-LC5-0.9mm/2mm	Pigtail Armored LC, MM 50/125um (900um Jacket)/ (2mm Jacket)	80.00
	F-PTA-FC5-0.9mm/2mm	Pigtail Armored FC, MM 50/125um (900um Jacket)/ (2mm Jacket)	80.00

## Patch Cord / Patch Cord Armored



### FEATURES

- Comply with : JIS C-5973, IEC, Bellcore
- High stable mating and de-mating characteristics
- Low insertion loss and high return loss
- Designed for variable cable
- Customized assembly
- Various connector and optical performance combinations

### SPECIFICATIONS

Characteristics		Values
Structure	Satisfied Telcordia	GR-326-CORE
Fiber Type		SM(9/125), MM(50/125,62.5/125)
Insertion Loss		≤ 0.2dB (against master connector)
Return Loss	SPC	≥ 40dB
	UPC	≥ 55dB
Operating		≤ 0.2dB (500times)
Operating temperature stability		≤ 0.3dB (- 40°C ~ + 75°C)

# Accessories for Fiber Optic Product



## Fiber Optic Patch Cord / Patch Cord Armored

### ORDERING INFORMATION

PRODUCT	PARTNUMBER	DESCRIPTION	PRICE
UPC SM	F-PC-STST9-3-DX	Patch Cord ST-ST, SM 9/125um, Duplex, 3M	250.00
	F-PC-STSC9-3-DX	Patch Cord ST-SC, SM 9/125um, Duplex, 3M	250.00
	F-PC-STLC9-3-DX	Patch Cord ST-LC, SM 9/125um, Duplex, 3M	250.00
	F-PC-STFC9-3-DX	Patch Cord ST-FC, SM 9/125um, Duplex, 3M	250.00
	F-PC-SCSC9-3-DX	Patch Cord SC-SC, SM 9/125um, Duplex, 3M	250.00
	F-PC-SCFC9-3-DX	Patch Cord SC-FC, SM 9/125um, Duplex, 3M	250.00
	F-PC-LCSC9-3-DX	Patch Cord LC-SC, SM 9/125um, Duplex, 3M	250.00
	F-PC-LCLC9-3-DX	Patch Cord LC-LC, SM 9/125um, Duplex, 3M	250.00
	F-PC-FCLC9-3-DX	Patch Cord LC-FC, SM 9/125um, Duplex, 3M	250.00
	F-PC-FCFC9-3-DX	Patch Cord FC-FC, SM 9/125um, Duplex, 3M	250.00
	F-PC-MTRJ-MTRJ9-3-DX	Patch Cord MTRJ-MTRJ, SM 9/125um, Duplex, 3M	500.00
	F-PC-MTRJ-SC9-3-DX	Patch Cord MTRJ-SC, SM 9/125um, Duplex, 3M	400.00
FLEX Angle Boot SM	F-PC-F-FALCLC9-3-DX	Patch Cord LC-LC, SM 9/125um, Flex Angle Boot, Duplex, 3M	350.00
	F-PC-F-FALCSC9-3-DX	Patch Cord LC-SC, SM 9/125um, Flex Angle Boot, Duplex, 3M	350.00
	F-PC-F-FASCSC9-3-DX	Patch Cord SC-SC, SM 9/125um, Flex Angle Boot, Duplex, 3M	350.00
UPC MM	F-PC-STST5-3-DX	Patch Cord ST-ST, MM 50/125um, Duplex, 3M	250.00
	F-PC-SCST5-3-DX	Patch Cord ST-SC, MM 50/125um, Duplex, 3M	250.00
	F-PC-LCST5-3-DX	Patch Cord ST-LC, MM 50/125um, Duplex, 3M	250.00
	F-PC-FCST5-3-DX	Patch Cord ST-FC, MM 50/125um, Duplex, 3M	250.00
	F-PC-SCSC5-3-DX	Patch Cord SC-SC, MM 50/125um, Duplex, 3M	250.00
	F-PC-LCSC5-3-DX	Patch Cord SC-LC, MM 50/125um, Duplex, 3M	250.00
	F-PC-FCSC5-3-DX	Patch Cord SC-FC, MM 50/125um, Duplex, 3M	250.00
	F-PC-LCLC5-3-DX	Patch Cord LC-LC, MM 50/125um, Duplex, 3M	250.00
	F-PC-FCLC5-3-DX	Patch Cord LC-FC, MM 50/125um, Duplex, 3M	250.00
	F-PC-FCFC5-3-DX	Patch Cord FC-FC, MM 50/125um, Duplex, 3M	250.00
FLEX Angle Boot MM	F-PC-F-FALCLC5-3-DX	Patch Cord LC-LC, MM 50/125um, Flex Angle Boot, Duplex, 3M	350.00
	F-PC-F-FALCSC5-3-DX	Patch Cord LC-SC, MM 50/125um, Flex Angle Boot, Duplex, 3M	350.00
	F-PC-F-FASCSC5-3-DX	Patch Cord SC-SC, MM 50/125um, Flex Angle Boot, Duplex, 3M	350.00
UPC SM Armored	F-PCA-STST9-3-DX	Patch Cord Armored ST-ST, SM 9/125um, Duplex, 3M	320.00
	F-PCA-STSC9-3-DX	Patch Cord Armored ST-SC, SM 9/125um, Duplex, 3M	320.00
	F-PCA-STLC9-3-DX	Patch Cord Armored ST-LC, SM 9/125um, Duplex, 3M	320.00
	F-PCA-STFC9-3-DX	Patch Cord Armored ST-FC, SM 9/125um, Duplex, 3M	320.00
	F-PCA-SCSC9-3-DX	Patch Cord Armored SC-SC, SM 9/125um, Duplex, 3M	320.00
	F-PCA-SCFC9-3-DX	Patch Cord Armored SC-FC, SM 9/125um, Duplex, 3M	320.00
	F-PCA-LCSC9-3-DX	Patch Cord Armored LC-SC, SM 9/125um, Duplex, 3M	320.00
	F-PCA-LCLC9-3-DX	Patch Cord Armored LC-LC, SM 9/125um, Duplex, 3M	320.00
	F-PCA-FCLC9-3-DX	Patch Cord Armored LC-FC, SM 9/125um, Duplex, 3M	320.00
	F-PCA-FCFC9-3-DX	Patch Cord Armored FC-FC, SM 9/125um, Duplex, 3M	320.00
	F-PCA-MTRJ-MTRJ9-3-DX	Patch Cord Armored MTRJ-MTRJ, SM 9/125um, Duplex, 3M	630.00
	F-PCA-MTRJ-SC9-3-DX	Patch Cord Armored MTRJ-SC, SM 9/125um, Duplex, 3M	500.00
UPC MM Armored	F-PCA-STST5-3-DX	Patch Cord Armored ST-ST, MM 50/125um, Duplex, 3M	320.00
	F-PCA-SCST5-3-DX	Patch Cord Armored ST-SC, MM 50/125um, Duplex, 3M	320.00
	F-PCA-LCST5-3-DX	Patch Cord Armored ST-LC, MM 50/125um, Duplex, 3M	320.00
	F-PCA-FCST5-3-DX	Patch Cord Armored ST-FC, MM 50/125um, Duplex, 3M	320.00
	F-PCA-SCSC5-3-DX	Patch Cord Armored SC-SC, MM 50/125um, Duplex, 3M	320.00
	F-PCA-LCSC5-3-DX	Patch Cord Armored SC-LC, MM 50/125um, Duplex, 3M	320.00
	F-PCA-FCSC5-3-DX	Patch Cord Armored SC-FC, MM 50/125um, Duplex, 3M	320.00
	F-PCA-LCLC5-3-DX	Patch Cord Armored LC-LC, MM 50/125um, Duplex, 3M	320.00
	F-PCA-FCLC5-3-DX	Patch Cord Armored LC-FC, MM 50/125um, Duplex, 3M	320.00
	F-PCA-FCFC5-3-DX	Patch Cord Armored FC-FC, MM 50/125um, Duplex, 3M	320.00



# Accessories for Fiber Optic Product



**Coming Soon** Fiber Optic Patch Cord Out Door

**IP-67 WATERPROOF**



- Cost effective Solution for in house termination
- IP68 Water immersion and Dust protection for harsh environment
- Wide range of operational temperature for outside plant -40°C / +70 per
- Wide range of cables to be used, 5-8mm OD cable with two 2.0mm to 3.0mm jacketed subunits
- Chemical Resistance
- Interchangeable to other Industrial LC adaptor per IEC 61076-3-106
- Simple assembly requiring no special tools
- Durable mechanical mating, minimum of 500 matings.



## ODC

- ODC-2, ODC-4, ODC-6, ODC-10 channels can select
- Robust minicord-breakout or field cable
- Singlemode (SM) and Multimode (MM)
- Halogen free and low Smoke
- UL OFNR or OFNP rated cable available
- High shock, vibration and mechanical resistance
- Compact design with 2x1.25mm Zirconia ferrule technology
- Blind insertion design, easy and cost effective installation
- Waterproof, dust proof and corrosion resistant
- Waterproof protection caps
- Scoop and bling proof
- Harsh environment application
- Additional alignment pins to gain better Optical performance
- Broad temperature range and wide range of indoor cable
- Screw quick thread coupling with indicated mark, hand tight with visual check mark
- EMI protected and RoHS compliant

บริษัท โฟค้อม (ประเทศไทย) จำกัด

12 ซอยสุขาภิบาล 5 ซอย 5 แยก 3 แขวงท่าแร้ง เขตบางเขน กรุงเทพฯ 10220 โทร. 063-391-5262 โทร. 02-557-6451 แฟกซ์. 02-557-6452

[www.focomm-cabling.com](http://www.focomm-cabling.com)



## Fiber Optic Connector and Adapter

### Connector



SC



FC



ST



LC



MU



MT-RJ

### FEATURES

- Comply with : JIS C-5973, IEC, Telcordia
- High stable mating and de-mating characteristics
- Optimum optical performance through high quality ferrule
- Designed for variable cable dia.
- Available long flange for ferrule and Angled ferrule
- Widely used for LD/PD modules

### Adapter



ST (SM/MM)



FC (SM/MM)



SC Simplex (SM/MM)



SC Duplex (SM/MM)



LC Duplex (SM/MM)



LC Quad (SM/MM)

### Hybrid Adaptors



ST-FC Hybrid Adaptors



SC-FC Hybrid Adaptors



ST-SC Hybrid Adaptors

### FEATURES

- Comply with : JIS, IEC, Bellcore
- Precision sleeve (Zirconia & Bronze)
- Various type available
- Integrated body structure

### ORDERING INFORMATION

#### Connector

PRODUCT	PARTNUMBER	DESCRIPTION	PRICE
Connector	F-CN-ST9-SX	ST Connector Simplex, SM	40.00
	F-CN-SC9-SX	SC Connector Simplex, SM	40.00
	F-CN-SC9-DX	SC Connector Duplex, SM	80.00
	F-CN-LC9-SX	LC Connector Simplex, SM	55.00
	F-CN-LC9-DX	LC Connector Duplex, SM	110.00
	F-CN-FC9-SX	FC Connector Simplex, SM	40.00
	F-CN-ST5-SX	ST Connector Simplex, MM	40.00
	F-CN-SC5-SX	SC Connector Simplex, MM	40.00
	F-CN-SC5-DX	SC Connector Duplex, MM	80.00
	F-CN-LC5-SX	LC Connector Simplex, MM	55.00
	F-CN-LC5-DX	LC Connector Duplex, MM	110.00
	F-CN-FC5-SX	FC Connector Simplex, MM	40.00
Adapter SM	F-AD-ST9	ST Adapter SM	40.00
	F-AD-SC9-SX	SC Adapter Simplex SM	40.00
	F-AD-SC9-DX	SC Adapter Duplex SM	80.00
	F-AD-LC9-SX	LC Adapter Simplex SM	55.00
	F-AD-LC9-DX	LC Adapter Duplex SM	110.00
	F-AD-LC9-QX	LC Adapter Quad SM	130.00
	F-AD-FC9	FC Adapter SM	40.00
Adapter MM	F-AD-ST5	ST Adapter MM	40.00
	F-AD-SC5-SX	SC Adapter Simplex MM	40.00
	F-AD-SC5-DX	SC Adapter Duplex MM	80.00
	F-AD-LC5-SX	LC Adapter Simplex MM	55.00
	F-AD-LC5-DX	LC Adapter Duplex MM	110.00
	F-AD-LC5-QX	LC Adapter Quad MM	130.00
	F-AD-FC5	FC Adapter MM	40.00
Adapter Hybrid	F-HAD-STFC9	ST to FC Adapter, SM	1,000.00
	F-HAD-SCFC9	SC to FC Adapter, SM	1,000.00
	F-HAD-STSC9	ST to SC Adapter, SM	1,000.00

## Adapter plates

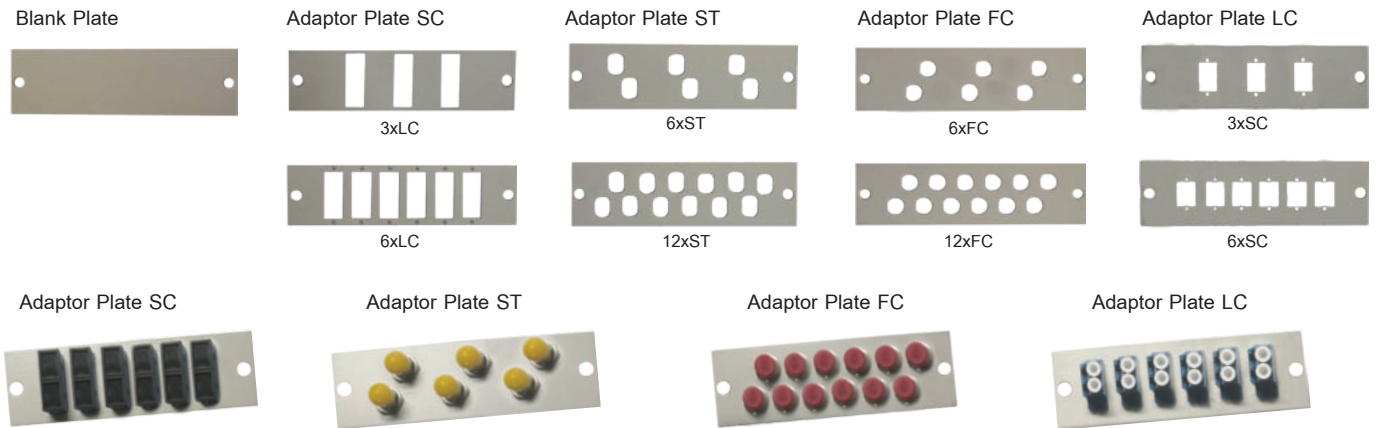

## FEATURES

- Snap Plate Sheet made of Aluminum thickness 2.0 mm Gray Anodized, in lightweight but durable.
- Lock system in Snap On, easier in using without screwing
- Number of port, in 2 options 6, 12 ports
- Applicable with many connector ST, SC, FC, and LC
- Designed for convenient use with FDU, Rack Mount Drawer and Wall Mount Enclosure.
- With Blank Adapter Snap Plate, in both 6 and 12 ports, made of Aluminum to cover Adapter Snap Plate not in use.
- Polycarbonate (UL 94V-0) housing
- Alignment sleeve made by Ceramic for Single-mode & Phosphor Bronze for Multi-mode
- Meet standard TIA/EIA-568-C.3, ISO/IEC 11801

## ORDERING TABLE

PRODUCT	PART NUMBER	DESCRIPTION	PRICE
Adapter Plate	F-BK	Blank Plate	30.00
	F-3SC-DX	Adapter Plate 3xSC Duplex	50.00
	F-6SC-DX	Adapter Plate 6xSC Duplex	50.00
	F-6ST-SX	Adapter Plate 6xST Simplex	50.00
	F-12ST-SX	Adapter Plate 12xST Simplex	50.00
	F-6FC-SX	Adapter Plate 6xFC Simplex	50.00
	F-12FC-SX	Adapter Plate 12xFC Simplex	50.00
	F-3LC-DX	Adapter Plate 3xLC Duplex	50.00
	F-6LC-DX	Adapter Plate 6xLC Duplex	50.00
	SC Adapter Plate	F-AP-3SC9-DX	Adapter Plate 3xSC Duplex, SM
F-AP-6SC9-DX		Adapter Plate 6xSC Duplex, SM	480.00
F-AP-3SC5-DX		Adapter Plate 3xSC Duplex, MM	240.00
F-AP-6SC5-DX		Adapter Plate 6xSC Duplex, MM	480.00
ST Adapter Plate	F-AP-6ST9-SX	Adapter Plate 6xST Simplex, SM	240.00
	F-AP-12ST9-SX	Adapter Plate 12xST Simplex, SM	480.00
	F-AP-6ST5-SX	Adapter Plate 6xST Simplex, MM	240.00
	F-AP-12ST5-SX	Adapter Plate 12xST Simplex, MM	480.00
FC Adapter Plate	F-AP-6FC9-SX	Adapter Plate 6xFC Simple, SM	240.00
	F-AP-12FC9-SX	Adapter Plate 12xFC Simplex, SM	480.00
	F-AP-6FC5-SX	Adapter Plate 6xFC Simplex, MM	240.00
	F-AP-12FC5-SX	Adapter Plate 12xFC Simplex, MM	480.00
LC Adapter Plate	F-AP-3LC9-DX	Adapter Plate 3xLC Duplex SM	300.00
	F-AP-6LC9-DX	Adapter Plate 6xLC Duplex SM	550.00
	F-AP-3LC5-DX	Adapter Plate 3xLC Duplex MM	300.00
	F-AP-6LC5-DX	Adapter Plate 6xLC Duplex MM	550.00

## Distribution Panel (FDU)

### Rack Mount Drawer



1U

#### FEATURES

- ST, SC, FC, LC Adapter Connectors
- 3 Snap-Plate, 6-36Fiber, 1U



2U

#### FEATURES

- ST, SC, FC, LC Adapter Connectors
- 6 Snap-Plate, 6-72Fiber, 2U

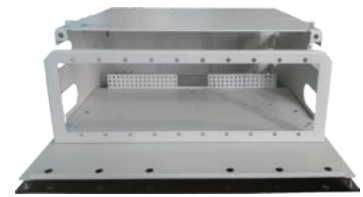

4U

#### FEATURES

- ST, SC, FC, LC Adapter Connectors
- 10 Snap-Plate, 6-120Fiber, 4U

### Wall Mount



#### FEATURES

- A joint for connecting fiber optic cables have a minimum of 24, 48 pcs per connector.
- Can be use with multi-mode or single-mode fiber optic adaptor in the same panel.
- For vertical or primary cabling, in primary distribution rooms or cabinets, for the administration and management of optical backbones.
- For horizontal or secondary cabling, in telecommunications rooms (interconnect or cross-connect), for services distribution in horizontal systems.

### Splice Tray



Splice Tray 12 Cores



Splice Tray 24 Cores



Full Moon Cable Routing



Protection Sleeve 60mm



Fiber Mechanical Splice

### ORDERING TABLE

PRODUCT	PARTNUMBER	DESCRIPTION	PRICE
Rack Mount Drawer	F-RMA-36	Rack Mount Drawer, 3 Snap-Plate, 6-36Fiber, 1U (43x26x4.5 cm)	1,800.00
	F-RMA-72	Rack Mount Drawer, 6 Snap-Plate, 6-72Fiber, 2U	3,000.00
	F-RMA-120	Rack Mount Drawer, 6 Snap-Plate, 6-120Fiber, 4U	5,000.00
Wall Mount	F-WM-24	Wall Mount, 2 Snap-Plate, 6-24Fiber (30x30x5 cm)	1,200.00
	F-WM-48	Wall Mount, 4 Snap-Plate, 6-48Fiber (30x30x10 cm)	2,200.00
Splice Tray	F-Tray-12	Splice Tray 12 Cores	100.00
	F-Tray-24	Splice Tray 24 Cores	160.00
	F-FM	Full Moon Cable Routing	40.00
	F-PT-60	Protection Sleeve 60mm	4.00
	F-MS	Fiber Mechanical Splice	80.00

## Fiber Enclouse

### Under Water Fiber Enclouse



44 Core



72 Core



144 Core

#### Features

- Closure provides perfect solution for the protection of the junction point of optical fiber cable from environment
- Silicone gasket is used to seal closure and provide a long term reliability.
- Closures have two or three cable entrance ports on each end.
- Closures can be installed at temperatures between -40°F~176°F (-40°C~80°C)

### F.O. Splice Closure, In-Line Type

F.O. Splice Closure, In-Line Type, 12, 24Cores / 1, 2 Tray(12Fiber)

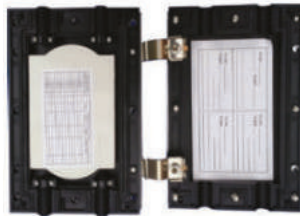

#### Features

- Widely used in FTTH Network.
- Telecommunication Networks
- CATV Networks
- Data communications Networks
- Local Area Networks

F.O. Splice Closure, In-Line Type, 48, 96Cores / 2, 4 Tray(24Fiber)



#### Features

- Widely used in FTTH Network.
- Telecommunication Networks
- CATV Networks
- Data communications Networks
- Local Area Networks

F.O. Splice Closure, Dome Type, 24, 48, 96Cores / 2, 4 Tray (12 Fiber)



#### Features

- Widely used in FTTH Network.
- Telecommunication Networks
- CATV Networks
- Data communications Networks
- Local Area Networks

### ORDERING TABLE

PRODUCT	PART NUMBER	DESCRIPTION	PRICE
Under water Fiber Enclouse	F-FOC-S	F.O Splice Closure, In-Line Type, Under Water, 44 Core	3,000.00
	F-FOC-SS	F.O Splice Closure, In-Line Type, Under Water, 72 Core	4,000.00
	F-FOC-M	F.O Splice Closure, In-Line Type, Under Water, 144 Core	5,000.00
Splice Closure In-Line Type	F-CS12-IL	F.O. Splice Closure, In-Line Type, 12Cores / 1 Tray(12Fiber)	800.00
	F-CS24-IL	F.O. Splice Closure, In-Line Type, 24Cores / 2 Tray(12Fiber)	1,000.00
	F-CS48-IL	F.O. Splice Closure, In-Line Type, 48Cores / 2 Tray(24Fiber)	1,500.00
	F-CS96-IL	F.O. Splice Closure, In-Line Type, 96Cores / 4 Tray (24Fiber)	2,000.00
Splice Closure Dome Type	F-CS24-D	F.O. Splice Closure, Dome Type, 24Cores / 2 Tray (12 Fiber)	1,200.00
	F-CS48-D	F.O. Splice Closure, Dome Type, 48Cores / 2 Tray (24 Fiber)	1,500.00
	F-CS96-D	F.O. Splice Closure, Dome Type, 96Cores / 4 Tray (24 Fiber )	2,000.00



## Optical Fiber Distribution Frame (144-576 )



### Features

- This frame is made of top quality steel and deformed aluminum alloy and treated with galvanizing, oxidation and electrostatic plastic spraying. The frame has solid structure and pleasing appearance.
- Fully-closed structure with the advantages of good performance of dust-proof, pleasing and neat appearance.
- Enough space for fiber distribution and storage space and very easy for installation and operations.
- Fully front side operation, convenient for maintenances.
- Splice and distribution are separated and spread uniformly on the top and bottom sides of the frame. Compact structure and distinct layer for convenient management.
- Frisbee style (UFO style) splice tray is adopted; up to 48 trays can be hold in one frame.
- Curvature radius of 40mm.
- This frame is suitable for both common bundle cables and ribbon type cables.
- Reliable cable fixture cover and earth protection device provided

## Optical Fiber Distribution Frame ( 504-1440 )



### Features

- Fully-closed structure with the advantages of good performance of dust-proof, pleasing and neat appearance.
- Enough space for fiber distribution and storage space and very easy for installation and operations.
- Fully front side operation, convenient for maintenances.
- Curvature radius of 40mm.
- Reliable cable fixture cover and earth protection device provided.
- Each unit holds up to 12 FC adapters and up to 24 SC/LC adapters.
- Every 6 units make up a module. Dual SC adapters could double the capacity of Splice and distribution units' capacities to max 24FO each.
- No screw needed for installing adapters.

## Optical Fiber Distribution Frame (1296-1728 )



### Features

- This frame reached YD/T778, YD/T694 standards and Chinese telecom enterprise product standard “ Optical Fiber Main Distribution Frame (double-sided operation)”.
- Double-sided operation: Line modules at front side are used to outside cable fixing, stripping, splice and terminal Row modules at back side are used to terminal equipments' pigtailed and patch cords, left side fixing equipments' pigtailed, as well as right side fiber-winding shaft.
- Line: SC or FC 12 cores adapter is installed on the drawer-type 12 cores integrated tray, and the tray is installed on the tray rack mount; Row: SC or FC 12 cores adapter is installed on the revolving 12 cores integrated tray, and the tray is installed in the 72 cores unit cabinet.
- Cables and fibers can be inlet from the top of the frame through separate entrances.
- Multilayer horizontal fiber trays are installed on the row modules of the frame, convenient for frames combining.

### ORDERING TABLE

PRODUCT	PARTNUMBER	DESCRIPTION	PRICE
Optical Fiber Distribution Frame (144-576 )	F-GPX82-1-2-6CW-144	Optical Fiber Distribution Frame 144 Core 2000*600*300	Call
	F-GPX82-1-2-5CW-246	Optical Fiber Distribution Frame 216 Core 2200*600*300	Call
	F-GPX82-1-2-4CW-288	Optical Fiber Distribution Frame 288 Core 2600*600*300	Call
	F-GPX82-1-2-3CW-288	Optical Fiber Distribution Frame 288 Core 2000*900*300	Call
	F-GPX82-1-2-2CW-432	Optical Fiber Distribution Frame 432 Core 2200*900*300	Call
	F-GPX82-1-2-1CW-567	Optical Fiber Distribution Frame 576 Core 2600*900*300	Call
Optical Fiber Distribution Frame ( 504-1440 )	F-GPX82-4-3CW-504	Optical Fiber Distribution Frame 504 Core 2000*840*300	Call
	F-GPX82-4-2CW-576	Optical Fiber Distribution Frame 576 Core 2200*840*300	Call
	F-GPX82-4-1CW-720	Optical Fiber Distribution Frame 720 Core 2600*840*300	Call
	F-GPX82-4-3CW-1008	Optical Fiber Distribution Frame 1008 Core 2000*840*300	Call
	F-GPX82-4-2CW-1152	Optical Fiber Distribution Frame 1152 Core 2200*840*300	Call
Optical Fiber Distribution Frame (1296-1728 )	F-GPX09S-1CW-1296	Optical Fiber Distribution Frame 1296 Core 2000*880*300	Call
	F-GPX09S-2CW-1440	Optical Fiber Distribution Frame 1440 Core 2200*880*300	Call
	F-GPX09S-3CW-1728	Optical Fiber Distribution Frame 1728 Core 2600*880*300	Call

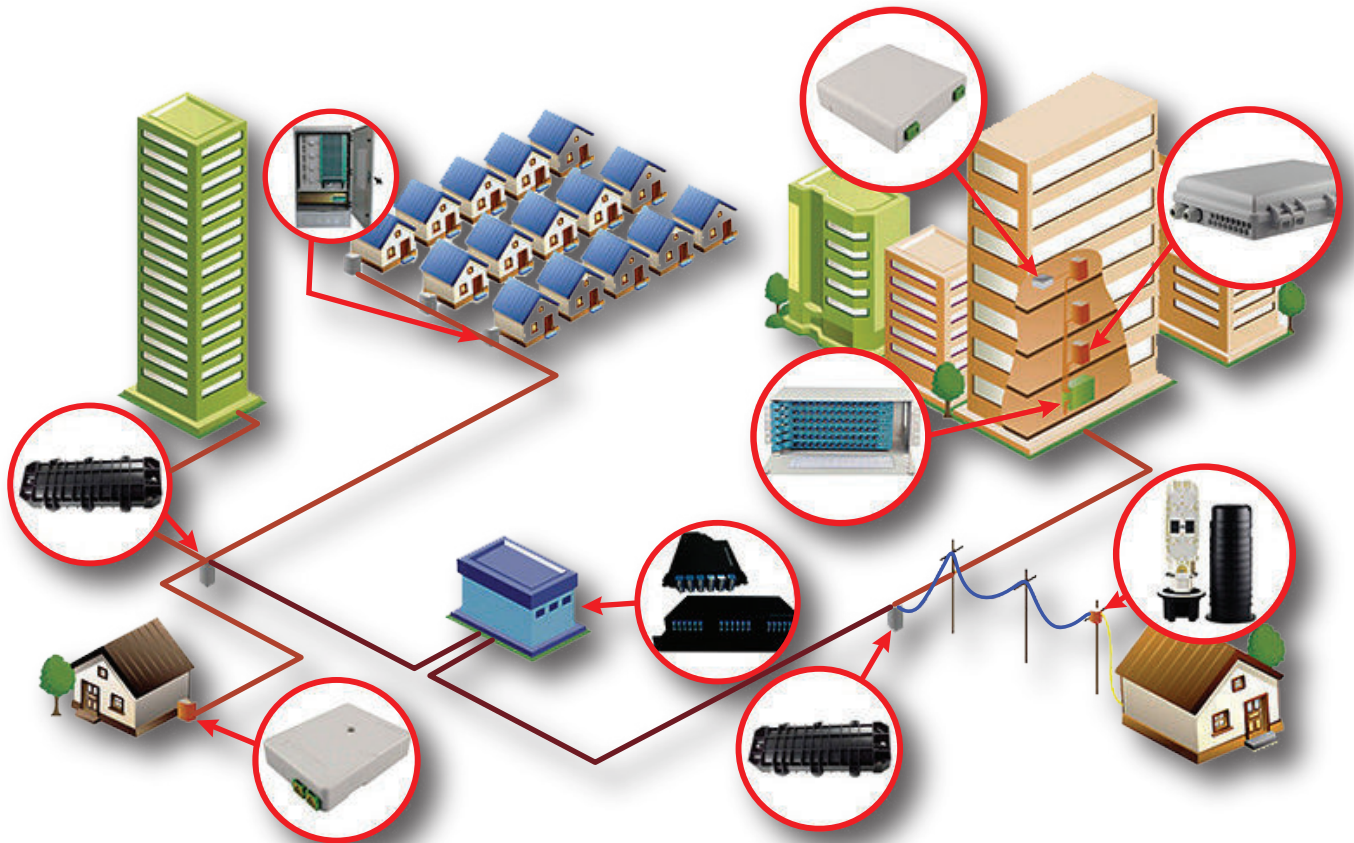

# FTTH (Fiber Optic To The Home)

- FTTH Strand Drop Wire Round
- FTTH Strand Drop Wire Flat
- FTTH Strand Fig-8 Drop Wire Flat
- Accessories for FTTH
- FTTH Terminal Box Indoor
- Wall Mount Outdoor

## FTTX Strand Drop Wire Round

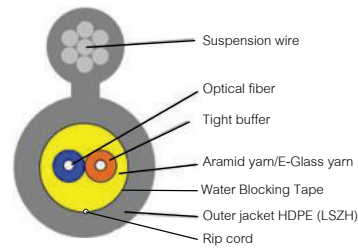
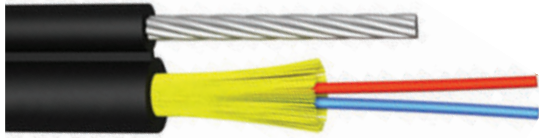

### PROPERTIES

- Excellent performance
- Low insertion loss and high return loss
- High tensile strength
- Telcorda GR326, IEC, TIA/EIA standard compliant

### APPLICATION

- Communication network
- Optical distribution network
- Lan system
- FTTH

### STANDARD

ANSI/TIA-568-C.3, ANSI/TIA/EIA-568-B.3, ISO/IEC 11801:2002, ANSI/ICEA 696, Telcordia (Bellcore) GR-20-CORE, ITU-T G.652D (Singlemode), ITU-T G.651 (Multimode), IEC 60332-1, IEC 60332-2& IEC 60332-3, IEC 60793/60794, ANSI/ICEA 596,EIA/TIA-455, UL, RoHS Compliant 2002/95/EC

## FTTX Strand Drop Wire Flat

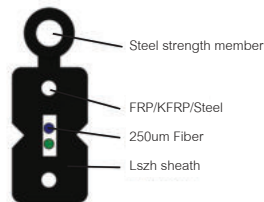
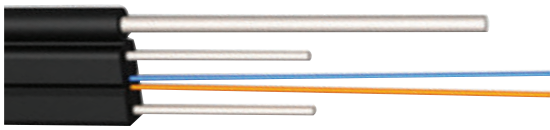

### PROPERTIES

- Excellent performance
- Low insertion loss and high return loss
- High tensile strength
- Telcorda GR326, IEC, TIA/EIA standard compliant

### APPLICATION

- Adopted to outdoor level and vertical distribution.
- Suitable for connect with communication equipment.
- Long distance and local area network communication.

### STANDARD

ANSI/TIA-568-C.3, ANSI/TIA/EIA-568-B.3, ISO/IEC 11801:2002, ANSI/ICEA 696, Telcordia (Bellcore) GR-20-CORE, ITU-T G.652D (Singlemode), ITU-T G.651 (Multimode), IEC 60332-1, IEC 60332-2& IEC 60332-3, IEC 60793/60794, ANSI/ICEA 596,EIA/TIA-455, UL, RoHS Compliant 2002/95/EC

## FTTX Strand Fig-8 Drop Wire Flat

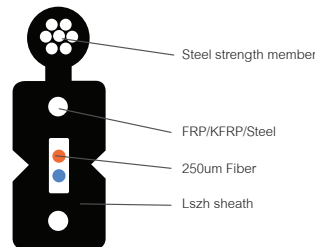
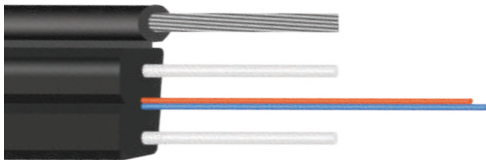

### PROPERTIES

- Excellent performance
- Low insertion loss and high return loss
- High tensile strength
- Telcorda GR326, IEC, TIA/EIA standard compliant

### APPLICATION

- Adopted to outdoor level and vertical distribution.
- Suitable for connect with communication equipment.
- Long distance and local area network communication.

### STANDARD

ANSI/TIA-568-C.3, ANSI/TIA/EIA-568-B.3, ISO/IEC 11801:2002, ANSI/ICEA 696, Telcordia (Bellcore) GR-20-CORE, ITU-T G.652D (Singlemode), ITU-T G.651 (Multimode), IEC 60332-1, IEC 60332-2& IEC 60332-3, IEC 60793/60794, ANSI/ICEA 596,EIA/TIA-455, UL, RoHS Compliant 2002/95/EC

### Ordering Table

PRODUCT	PART NUMBER	DESCRIPTION	PRICE
FTTX Strand Drop Wire Round	F-FTTX-SDR-01	FTTX Strand Drop Wire Round 1 Core	7.00
	F-FTTX-SDR-02	FTTX Strand Drop Wire Round 2 Core	8.00
	F-FTTX-SDR-04	FTTX Strand Drop Wire Round 4 Core	10.00
FTTX Strand Drop Wire Flat	F-FTTX-SDF-01	FTTX Strand Drop Wire Flat 1 Core	4.50
	F-FTTX-SDF-02	FTTX Strand Drop Wire Flat 2 Core	5.00
	F-FTTX-SDF-04	FTTX Strand Drop Wire Flat 4 Core	8.00
FTTX Strand Fig-8 Drop Wire Flat	F-FTTX-SDF8-01	FTTX Strand Fig-8 Drop Wire Flat 1 Core	3.00
	F-FTTX-SDF8-02	FTTX Strand Fig-8 Drop Wire Flat 2 Core	3.50
	F-FTTX-SDF8-04	FTTX Strand Fig-8 Drop Wire Flat 4 Core	4.50

## FTTH Terminal Box Indoor

FTTH Terminal Box, 1 Port



FTTH Terminal Box, 2 Port



FTTH Terminal Box, 4 Port



### Features

- Accommodation of 1, 2, 4 adapters
- Easy installation
- Suitable for SC sx and LC dx adapters
- Widely used in FTTH Network.
- Telecommunication Networks
- CATV Networks

## Fiber Optic Cable-Coling Box, 15m

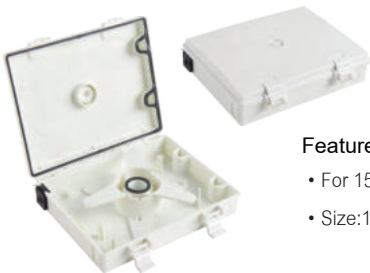

### Features

- For 15m optical cable
- Size:150(L) x 120(W) x 37(H)mm

## Multimedia Empty Metal Box



### Features

- Colour:Light Grey
- It Can be fixed with 19Inch Panel and other telecommunication Equipment
- Size:H:550mm, W540mm, D:200mm

## Wall Mount Outdoor (Plastic)



2 Core



4 Core



8 Core



16 Core



24 Core



8 Core PLC



24 Core PLC

### Features

- PP material used ensures the body strong and light.
- Wet-proof, water-proof, dust-proof, anti-aging
- Easy installations: Ready for wall mount – installation kits provided
- Space saving: Double-layer design for easier installation and maintenances

## Ordering Table

PRODUCT	PART NUMBER	DESCRIPTION	PRICE
FTTH Terminal Box Indoor	F-FTTH-BOX-01	FTTH Terminal Box, 1 Port	50.00
	F-FTTH-BOX-02	FTTH Terminal Box, 2 Port	60.00
	F-FTTH-BOX-04	FTTH Terminal Box, 4 Port	300.00
	F-FTTH-CL-Box	Fiber Optic Cable-Coling Box, 15m	500.00
Multimedia Empty Metal Box	F-FTTH-NB	Multimedia Empty Metal Box H:550mm, W540mm, D:200mm	2,000.00
Wall Mount Outdoor (plastic)	F-WM-FTTH-02	Wall Mount Outdoor, Plastic, Fiber Optic Box For FTTH Cable for 2 Core	800.00
	F-WM-FTTH-04	Wall Mount Outdoor, Plastic, Fiber Optic Box For FTTH Cable for 4 Core	1,200.00
	F-WM-FTTH-08	Wall Mount Outdoor, Plastic, Fiber Optic Box For FTTH Cable for 8 Core	1,800.00
	F-WM-FTTH-08-PLC	Wall Mount Outdoor, Plastic, Fiber Optic Box For FTTH Cable for 8 Core with PLC	2,500.00
	F-WM-FTTH-16	Wall Mount Outdoor, Plastic, Fiber Optic Box For FTTH Cable for 16 Core	2,500.00
	F-WM-FTTH-16-PLC	Wall Mount Outdoor, Plastic, Fiber Optic Box For FTTH Cable for 16 Core with PLC	4,000.00
	F-WM-FTTH-24	Wall Mount Outdoor, Plastic, Fiber Optic Box For FTTH Cable for 24 Core	3,500.00



## Blockless PLC Splitter

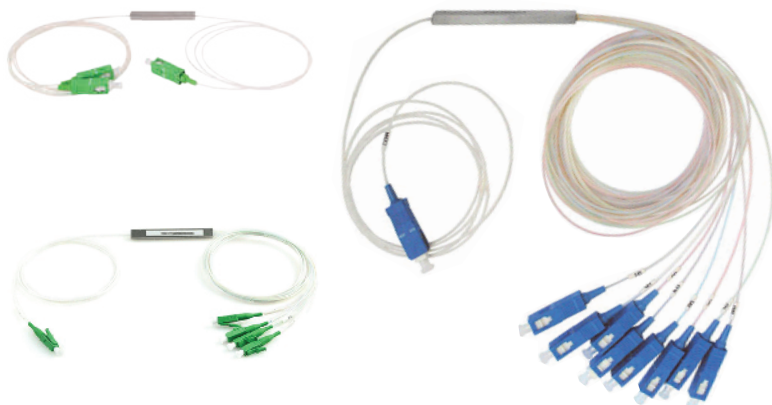

### Features

- Free 1X2,4,8,16,32 PLC Splitter Sample for evaluation
- Quick Delivery on Trial Order or Bulk Order
- Plastic Packing Protection from Shipment
- High quality PLC design features a protective metal casing around the fibers
- PLC splitting mechanism
- 900µm loose tube fiber for easy stripping, splicing, or terminating

### Characteristics

- Low insertion loss
- Low Polarization Dependent Loss
- Excellent Environmental Stability
- Excellent Mechanical Stability
- Telcordia GR-1221 and GR-1209
- Available in dual/three wavelength operation
- Available in 250um & 900um fiber.

## Module Type PLC Splitter

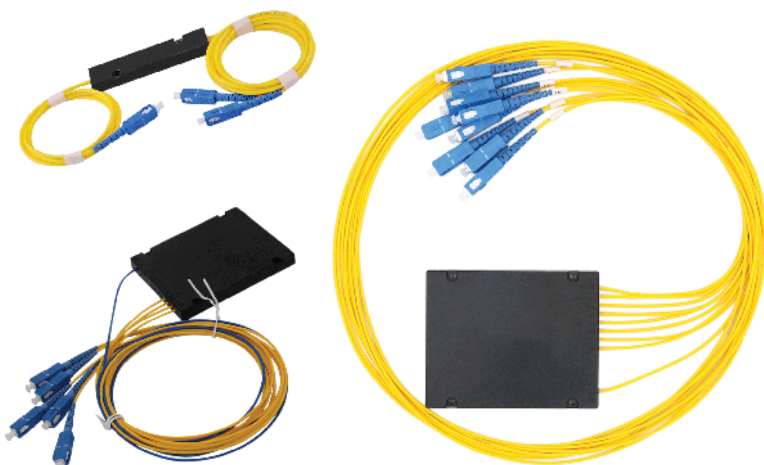

### Features

- Free 1×2,4,8,16,32 Single mode PLC SM Splitter Sample for evaluation
- Quick Delivery on Trial Order or Bulk Order
- Well Made Premium Fiber Cable
- Plastic Packing Protection from Shipment
- 100% Money Refund or Replacement with Quality Problem

### Characteristics

- Low insertion loss
- Low Polarization Dependent Loss
- Excellent Environmental Stability
- Excellent Mechanical Stability
- Telcordia GR-1221 and GR-1209
- Available in dual/three wavelength operation
- Available in 250um & 900um fiber, 2mm

### Ordering Table

PRODUCT	PART NUMBER	DESCRIPTION	PRICE
Blockless PLC Splitter	F-BPLC-APC-SC-0102-01	Blockless PLC Splitter 1x2, SC/APC, 1m	224.00
	F-BPLC-APC-SC-0104-01	Blockless PLC Splitter 1x4, SC/APC, 1m	280.00
	F-BPLC-APC-SC-0108-01	Blockless PLC Splitter 1x8, SC/APC, 1m	350.00
	F-BPLC-APC-SC-0116-01	Blockless PLC Splitter 1x16, SC/APC, 1m	595.00
	F-BPLC-APC-SC-0132-01	Blockless PLC Splitter 1x32, SC/APC, 1m	1,190.00
	F-BPLC-APC-LC-0102-01	Blockless PLC Splitter 1x2, LC/APC, 1m	238.00
	F-BPLC-APC-LC-0104-01	Blockless PLC Splitter 1x4, LC/APC, 1m	294.00
	F-BPLC-APC-LC-0108-01	Blockless PLC Splitter 1x8, LC/APC, 1m	364.00
	F-BPLC-APC-LC-0116-01	Blockless PLC Splitter 1x16, LC/APC, 1m	630.00
Module Type PLC Splitter	F-MPLC-APC-SC-0102-01	Module Type PLC Splitter 1x2, SC/APC, 2m	280.00
	F-MPLC-APC-SC-0104-01	Module Type PLC Splitter 1x4, SC/APC, 2m	350.00
	F-MPLC-APC-SC-0108-01	Module Type PLC Splitter 1x8, SC/APC, 2m	490.00
	F-MPLC-APC-SC-0116-01	Module Type PLC Splitter 1x16, SC/APC, 2m	770.00
	F-MPLC-APC-SC-0132-01	Module Type PLC Splitter 1x32, SC/APC, 2m	1,470.00
	F-MPLC-APC-LC-0102-01	Module Type PLC Splitter 1x2, LC/APC, 2m	336.00
	F-MPLC-APC-LC-0104-01	Module Type PLC Splitter 1x4, LC/APC, 2m	364.00
	F-MPLC-APC-LC-0108-01	Module Type PLC Splitter 1x8, LC/APC, 2m	490.00
	F-MPLC-APC-LC-0116-01	Module Type PLC Splitter 1x16, LC/APC, 2m	805.00
F-MPLC-APC-LC-0132-01	Module Type PLC Splitter 1x32, LC/APC, 2m	1,540.00	

## Wall Mount Outdoor Metal

Wall Mount Outdoor FTTH Metal Box



### Features

- With 3Pcs PG13.5 Cable Gland
- With 4Pcs Metal Mounting to fix on the wall
- To Output 24, 48 or 72 Branch FTTH Cable

96 Core Fiber Optic Cabinet (Splicing type)



### Features

- Material : SMC (Flake mold Plastic Reinforced With Plate Unsaturated Polyester Polyester Glass Fiber), Which Is Formed After High Temperature And High-Pressure Molding.
- Waterproof IP Grade : IP66
- Environment Temperature : -40°C ~ +60°C
- adapter FC, SC, LC
- Using Life : >30Years

96 Core Fiber Optic Cabinet (PLC Tray type)



### Features

- Material : SMC (Flake mold Plastic Reinforced With Plate Unsaturated Polyester Polyester Glass Fiber), Which Is Formed After High Temperature And High-Pressure Molding.
- Waterproof IP Grade : IP66
- Environment Temperature : -40°C ~ +60°C
- adapter FC, SC, LC
- Using Life : >30Years

PLC Splitter Tray SC type



### Features

- Tamper-Proof Packaging
- Compact design
- Excellent Mechanical
- Good channel-to-channel uniformity
- High Reliability and Stability

## Ordering Table

Code **XX** = SC, LC, FC

PRODUCT	PART NUMBER	DESCRIPTION	PRICE
Wall Mount Outdoor	F-WMB-24	Wall Mount Outdoor Fiber Optic Distribution Box 24 Core	2,500.00
	F-WMB-48	Wall Mount Outdoor Fiber Optic Distribution Box 48 Core	3,500.00
	F-WMB-72	Wall Mount Outdoor Fiber Optic Distribution Box 72 Core	4,500.00
	F-WMC-96-XX	Wall Mount Outdoor Fiber Optic Cabinet 96 Core(Splicing type)	10,000.00
	F-WMC-96-PLC	Wall Mount Outdoor Fiber Optic Cabinet 96 Core(PLC Tray type)	11,000.00
PLC Splitter Tray SC type	F-STB-08-PLC	1x8 PLC Splitter (SC UPC Type)	1,000.00
	F-STB-08-APLC	1x8 PLC Splitter (SC APC Type)	1,000.00
	F-STB-16-PLC	1x16 PLC Splitter (SC UPC Type)	2,000.00
	F-STB-16-APLC	1x16 PLC Splitter (SC APC Type)	2,000.00

## Stand Fiber Optic Cabinet

### Stand Fiber Optic Cabinet 96 Core



Splicing type

PLC Tray type

#### Features

- Material : SMC (Flake mold Plastic Reinforced With Plate Unsaturated Polyester Polyester Glass Fiber), Which Is Formed After High Temperature And High-Pressure Molding.
- Waterproof IP Grade : IP65
- Environment Temperature : -40°C ~ +60°C
- Using Life : >30Years

### Stand Fiber Optic Cabinet 144 Core



Splicing type

PLC Tray type

#### Features

- Material : SMC (Flake mold Plastic Reinforced With Plate Unsaturated Polyester Polyester Glass Fiber), Which Is Formed After High Temperature And High-Pressure Molding.
- Waterproof IP Grade : IP65
- Environment Temperature : -40°C ~ +60°C
- Using Life : >30Years

### Stand Fiber Optic Cabinet 288 Core



Splicing type

PLC Tray type

#### Features

- Material : SMC (Flake mold Plastic Reinforced With Plate Unsaturated Polyester Polyester Glass Fiber), Which Is Formed After High Temperature And High-Pressure Molding.
- Waterproof IP Grade : IP65
- Environment Temperature : -40°C ~ +60°C
- Using Life : >30Years

### Ordering Table

Code **XX** = SC, LC, FC

PRODUCT	PART NUMBER	DESCRIPTION	PRICE
Stand Fiber Optic Cabinet	F-FRO-96-XX	Stand Fiber Optic Cabinet 96 Core(Splicing type)	12,000.00
	F-FRO-96-PLC	Stand Fiber Optic Cabinet 96 Core(PLC Tray type)	13,000.00
	F-FRO-144-XX	Stand Fiber Optic Cabinet 144 Core(Splicing type)	18,000.00
	F-FRO-144-PLC	Stand Fiber Optic Cabinet 144 Core(PLC Tray type)	19,000.00
	F-FRO-288-XX	Stand Fiber Optic Cabinet 288 Core(Splicing type)	25,000.00
	F-FRO-288-PLC	Stand Fiber Optic Cabinet 288 Core(PLC Tray type)	26,000.00

## Patch Cord APC



SC-SC



SC-FC



FC-FC



Patch Cord Out door SC-SC APC

### Features

- PP material used ensures the body strong and light.
- Wet-proof, water-proof, dust-proof, anti-aging
- Easy installations: Ready for wall mount – installation kits provided
- Space saving: Double-layer design for easier installation and maintenances

## Pigtail APC



SC



FC

### Features

- Metal material for the max strength.
- Easy installations: Ready for wall mount – installation kits provided.
- Ready for splitters: designed space for adding splitters.
- Space saving! Double-layer design for easier installation and maintenances

## Fast Connector



SC Fast Connector UPC



SC Fast Connector APC

### Features

- SC FiberOptic Fast Connector
- Suit For FTTH Cable

## Aapter APC



SC Adapter Simplex , APC, SM



SC Adapter Duplex , APC, SM



FC Adapter APC

### Features

- Low insertional loss and back reflection loss
- High prcision alignment
- NTT-MU hardware compatibility, NTT & JIS compliance

## Ordering Table

PRODUCT	PART NUMBER	DESCRIPTION	PRICE
Patch Cord APC	F-APC-SCSC9-3-DX	Patch Cord SC-SC, APC, SM 9/125um, Duplex, 3M	250.00
	F-APC-SCFC9-3-DX	Patch Cord SC-FC, APC, SM 9/125um, Duplex, 3M	250.00
	F-APC-FCFC9-3-DX	Patch Cord FC-FC, APC, SM 9/125um, Duplex, 3M	250.00
Patch Cord out door APC	F-APC-OSCSC9-3-DX	Patch Cord Out door SC-SC, APC, SM 9/125um, Duplex, 3M	300.00
	F-APC-OSCSC9-5-DX	Patch Cord Out door SC-SC, APC, SM 9/125um, Duplex, 5M	340.00
	F-APC-OSCSC9-10-DX	Patch Cord Out door SC-SC, APC, SM 9/125um, Duplex, 10M	440.00
	F-APC-OSCSC9-15-DX	Patch Cord Out door SC-SC, APC, SM 9/125um, Duplex, 15M	540.00
	F-APC-OSCSC9-20-DX	Patch Cord Out door SC-SC, APC, SM 9/125um, Duplex, 20M	640.00
	F-APC-OSCSC9-25-DX	Patch Cord Out door SC-SC, APC, SM 9/125um, Duplex, 25M	740.00
Pigtail APC	F-PT-APCSC9-0.9mm/2mm	Pigtail SC, APC, SM 9/125um (900um Jacket)/ (2mm Jacket)	60.00
	F-PT-APCFC9-0.9mm/2mm	Pigtail FC, APC, SM 9/125um (900um Jacket)/ (2mm Jacket)	60.00
Adapter APC	F-AD-APCSC9-SX	SC Adapter Simplex , APC, SM	40.00
	F-AD-APCSC9-DX	SC Adapter Duplex , APC, SM	80.00
	F-AD-APCFC9	FC Adapter APC	40.00
Fast Connector	F-FC-SC-UPC	SC Fast Connector UPC	50.00
	F-FC-SC-APC	SC Fast Connector APC	50.00

## Additional

- Patch Cord Out door APC + 20.- Per M.



## FTTH Closure

F.O. Splice Closure for FTTH



### Features

- 1 Core Fiber Optical Cable Splicing Protector
- For Simplex SC adaptor

F.O. Splice Closure for FTTH



### Features

Unscrew 4 bolts and open the closure. The optical fiber cable or patch cords can be inputted in FOCS from two holes. Determine the length of fiber cable, to be stripped and fixed inside the FOCS. After stripping and fusion, seal the cable inputs with sealing tape. Screw 4 bolts.

F.O. Splice Closure for FTTH up 16-24 subscribers and 96 splicing points



### Features

- water-proof design with IP-68
- Integrated with flap-up splice cassette and adapter holder
- All stainless metal plate and anti-rusting bolts, nuts.
- Suitable for the fusion splice or mechanical splice
- 2 pcs of 1x8, 1x16 or 2x16 splitter can be installed as an option
- 16 ports cable entrance for drop cable, 24 adapter for drop cable patching

F.O. Splice Closure for FTTH 8 Subscribers PLC Splitter



### Features

- It made of plastic , perfect appearance.
- Modular splitter design, it can install 1x8,1x4,1x2 modular splitter.
- Easy to open and close, not need any tools
- Perfect fiber route design to ensure bend radius of fibers.
- Special design for water-proof,it can be IP 55.

F.O. Splice Closure for FTTH 16 Subscribers PLC Splitter



### Features

- It made of plastic , perfect appearance.
- Modular splitter design, it can install 1x8,1x4,1x2
- Easy to open and close, not need any tools
- Perfect fiber route design to ensure bend radius of fibers.
- Special design for water-proof,it can be IP 65.
- The closure has two space, each one is separately, operating independently.

## Ordering Table

PRODUCT	PART NUMBER	DESCRIPTION	PRICE
FTTH Closure	F-CS01-FTTH	F.O. Splice Closure for FTTH ,01 Core	200.00
	F-CS04-FTTH	F.O. Splice Closure for FTTH ,04 Core	500.00
	F-CS-FTTH	F.O. Splice Closure for FTTH up 16-24 subscribers and 96 splicing points	2,400.00
	F-CS02PLC-FTTH	F.O. Splice Closure for FTTH 2 Subscribers PLC Splitter	1,500.00
	F-CS04PLC-FTTH	F.O. Splice Closure for FTTH 4 Subscribers PLC Splitter	2,000.00
	F-CS08PLC-FTTH	F.O. Splice Closure for FTTH 8 Subscribers PLC Splitter	2,500.00
	F-CS16PLC-FTTH	F.O. Splice Closure for FTTH 16 Subscribers PLC Splitter	3,500.00

บริษัท โฟคคอมม (ประเทศไทย) จำกัด

12 ซอยสุขุมวิท 5 ซอย 5 แยก 3 แขวงท่าแร้ง เขตบางเขน กรุงเทพฯ 10220 โทร. 063-391-5262 โทร. 02-557-6451 แฟกซ์. 02-557-6452

www.focomm-cabling.com



## MPO Solution for Data Center

- MPO Rackmount for Data Center
- MPO Trunk Cable
- Patch Cord OM2
- Patch Cord OM3
- Patch Cord OM4



## MPO Rack Mount Slide 6-96F, 1U



### Features

- 4 MPO Cassette Snap-In
- Fits up to 6-96 fiber splices
- Fits 3 LGX fiber optic adapter panels
- Includes fiber splice trays, Made from SPCC steel

## MPO Cassette Snap-In



### Features

- High quality plastic allows for compact and durable cassettes
- Cassette offers a plug and play solution which saves assembly and termination times
- Cassette allows up to 12-24 fibers
- Single MPO adapter, with pins, APC type, key up to key down

## Modular 3U MTP/MPO-LC Patch Panel



### Features

- 12 MPO Cassette Snap-In
- UP to 288 Fiber LC Ports in 3U
- Flexibility to Mix Adapter Plates with Cassettes in Patch Panel
- Available in SM, OM1, OM2, OM3 and OM4 fiber grades

## Adapter Plate

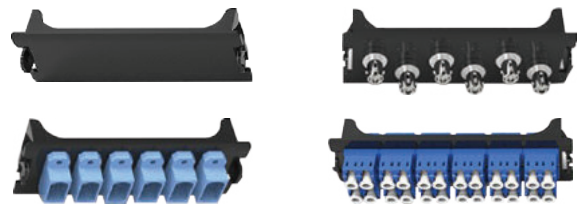

### Features

- Snap Plate Sheet made of plastic thickness 2.0 mm Black Anodized.
- Lock system in Snap On, easier in using without screwing
- Number of port, in 2 options 6, 12 ports
- Applicable with many connector ST, SC, FC, and LC
- Designed for convenient use with FDU, Rack Mount Drawer and Wall Mount Enclosure.

## Ordering Table

PRODUCT	PART NUMBER	DESCRIPTION	PRICE
MPO Rackmount for Data Center	F-RMA-MPO-96	MPO Rack Mount Slide 6-96F, 1U (4 MPO Cassette Snap-In)	2,400.00
	F-RMA-3UMPO-288	Modular 3U MTP/MPO-LC Patch Panel (12 MPO Cassette Snap-In)	5,000.00
MPO Cassette Snap-In	F-MPOC-50M3-LL-12LC	MPO Cassette Snap-In, 12LC, (MM,OM3), Low Loss	2,700.00
	F-MPOC-50M4-LL-12LC	MPO Cassette Snap-In, 12LC, (MM,OM4), Low Loss	2,750.00
	F-MPOC-90M2-LL-12LC	MPO Cassette Snap-In, 12LC, (SM), Low Loss	3,800.00
	F-MPOC-5XG-LL-24LC	MPO Cassette Snap-In, 24LC, (MM,XG), Low Loss	5,000.00
	F-MPOC-50M4-LL-24LC	MPO Cassette Snap-In, 24LC, (MM,OM4), Low Loss	5,200.00
	F-MPOC-90M2-LL-24LC	MPO Cassette Snap-In, 24LC, (SM), Low Loss	9,000.00
Adapter Plate	F-BKD	Blank Plate	50.00
SC Adapter Plate	F-APD-3SC9-DX	Adapter Plate 3xSC Duplex, SM	240.00
	F-APD-6SC9-DX	Adapter Plate 6xSC Duplex, SM	400.00
	F-APD-3SC5-DX	Adapter Plate 3xSC Duplex, MM	240.00
	F-APD-6SC5-DX	Adapter Plate 6xSC Duplex, MM	400.00
ST Adapter Plate	F-APD-6ST9-SX	Adapter Plate 6xST Simplex, SM	240.00
	F-APD-12ST9-SX	Adapter Plate 12xST Simplex, SM	400.00
	F-APD-6ST5-SX	Adapter Plate 6xST Simplex, MM	240.00
	F-APD-12ST5-SX	Adapter Plate 12xST Simplex, MM	400.00
FC Adapter Plate	F-APD-6FC9-SX	Adapter Plate 6xFC Simple, SM	240.00
	F-APD-12FC9-SX	Adapter Plate 12xFC Simplex, SM	400.00
	F-APD-6FC5-SX	Adapter Plate 6xFC Simplex, MM	240.00
	F-APD-12FC5-SX	Adapter Plate 12xFC Simplex, MM	400.00
LC Adapter Plate	F-APD-3LC9-DX	Adapter Plate 3xLC Duplex SM	300.00
	F-APD-6LC9-DX	Adapter Plate 6xLC Duplex SM	500.00
	F-APD-3LC5-DX	Adapter Plate 3xLC Duplex MM	300.00
	F-APD-6LC5-DX	Adapter Plate 6xLC Duplex MM	500.00

## MPO Trunk Cable

### MPO Array Cable (1-10m)



#### Features

- MTP and MPO are available. PC and APC polish meet standard requirement. Available for 8 and 12 fibers
- Support Method A, B, C and option for male and female for MTP/MPO.
- Further assemblies, fanout length and cable length available on request.

### MPO Trunk Cable (3-100m)



#### Features

- MTP and MPO are available. PC and APC polish meet standard requirement. 8~144 fibers are available (Further assemblies, 24 fibers available on request).
- Support Method A, B, C and option for male and female for MTP/MPO.
- Fanout Length : 24 inch at one end (total : 24 inch x 1 = 60.96cm)

### MPO Harness (3-25m)



#### Features

- Fiber connector interface available in ST, SC, FC, LC, MTP and MPO in forms of simplex channeling (further assemblies, 24 fibers MTP/MPO available on request)

### MPO Truck Harness (3-100m)



#### Features

- Fiber connector interface available in ST, SC, FC, LC, MTP and MPO in forms of simplex channeling (further assemblies, 24 fibers MTP/MPO available on request)

## Ordering Table

PRODUCT	PART NUMBER	DESCRIPTION	PRICE
MPO Array Cable (1-10m)	F-MPOAR-MM/OM3-3MM-12F	MPO-MPO Patch Cord Female-Female, MM/OM3, 3mm, 12F	Call
	F-MPOAR-MM/OM4-3MM-12F	MPO-MPO Patch Cord Female-Female, MM/OM4, 3mm, 12F	Call
	F-MPOAR-SM/OS2-3MM-12F	MPO-MPO Patch Cord Female-Female, SM/OS2, 3mm, 12F	Call
MPO Trunk Cable (3-100m)	F-MPOTR-MM/OM3-6.5MM-12F	MPO-MPO Trunk Cord Female-Female, MM/OM3, 6.5mm, 12F	Call
	F-MPOTR-MM/OM4-6.5MM-12F	MPO-MPO Trunk Cord Female-Female, MM/OM4, 6.5mm, 12F	Call
	F-MPOTR-SM/OS2-6.5MM-12F	MPO-MPO Trunk Cord Female-Female, SM/OS2, 6.5mm, 12F	Call
	F-MPOTR-MM/OM3-6.5MM-24F	MPO-MPO Trunk Cord Female-Female, MM/OM3, 6.5mm, 24F	Call
	F-MPOTR-MM/OM4-6.5MM-24F	MPO-MPO Trunk Cord Female-Female, MM/OM4, 6.5mm, 24F	Call
	F-MPOTR-SM/OS2-6.5MM-24F	MPO-MPO Trunk Cord Female-Female, SM/OS2, 6.5mm, 24F	Call
MPO Harness (3-25m)	F-MPOHA-MM/OM3-3MM-12F	MPO-LC Harness, MM/OM3, 3mm, 12F	Call
	F-MPOHA-MM/OM4-3MM-12F	MPO-LC Harness, MM/OM4, 3mm, 12F	Call
	F-MPOHA-SM/OS2-3MM-12F	MPO-LC Harness, SM/OS2, 3mm, 12F	Call
	F-MPOHA-MM/OM3-3.5MM-24F	MPO-LC Harness, MM/OM3, 3.5mm, 24F	Call
	F-MPOHA-MM/OM4-3.5MM-24F	MPO-LC Harness, MM/OM4, 3.5mm, 24F	Call
	F-MPOHA-SM/OS2-3.5MM-24F	MPO-LC Harness, SM/OS2, 3.5mm, 24F	Call
MPO Truck Harness (3-100m)	F-MPOTH-MM/OM3-6.5MM-12F	MPO-LC Truck Harness, MM/OM3, 6.5mm, 12F	Call
	F-MPOTH-MM/OM4-6.5MM-12F	MPO-LC Truck Harness, MM/OM4, 6.5mm, 12F	Call
	F-MPOTH-SM/OS2-6.5MM-12F	MPO-LC Truck Harness, SM/OS2, 6.5mm, 12F	Call
	F-MPOTH-MM/OM3-6.5MM-24F	MPO-LC Truck Harness, MM/OM3, 6.5mm, 24F	Call
	F-MPOTH-MM/OM4-6.5MM-24F	MPO-LC Truck Harness, MM/OM4, 6.5mm, 24F	Call
	F-MPOTH-SM/OS2-6.5MM-24F	MPO-LC Truck Harness, SM/OS2, 6.5mm, 24F	Call



## Pigtail OM3

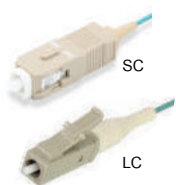

### Features

- fiber optic cable with 1 side connector (Pigtail Cable)
- SC, LC Connector
- Easy to release trigger connector

## Pigtail OM4

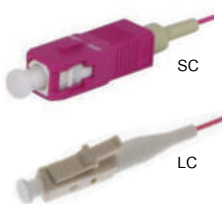

### Features

- fiber optic cable with 1 side connector (Pigtail Cable)
- SC, LC Connector
- Easy to release trigger connector

## OM2, Patch Cord



ST-ST



ST-SC



ST-LC



SC-SC



SC-LC



LC-LC

## OM3, Patch Cord



ST-ST



ST-SC



ST-LC



SC-SC



SC-LC



LC-LC

## OM4, Patch Cord



SC-LC



LC-LC

## Patch Cord Push-Pull Tab



### Features

- LC-LC, LC-SC, SC-SC UPC Connector
- Low insertion loss and reflection loss
- Push-pull Tab
- High-Speed, High-Bandwidth and Low-Cost
- Easy to release trigger connector
- Multimedia

## Ordering Table

PRODUCT	PART NUMBER	DESCRIPTION	PRICE
Pigtail, OM3	F-PT-OM3-SC9-0.9mm/2mm	Pigtail SC, OM3 MM 50/125um (900um Jacket)/ (2mm Jacket)	80.00
	F-PT-OM3-LC9-0.9mm/2mm	Pigtail LC, OM3 MM 50/125um (900um Jacket)/ (2mm Jacket)	80.00
Pigtail, OM4	F-PT-OM4-SC9-0.9mm/2mm	Pigtail SC, OM4 MM 50/125um (900um Jacket)/ (2mm Jacket)	85.00
	F-PT-OM4-LC9-0.9mm/2mm	Pigtail LC, OM4 MM 50/125um (900um Jacket)/ (2mm Jacket)	85.00
Patch Cord, OM 2	F-PC-OM2STST5-3-DX	OM2, Patch Cord ST-ST, MM 50/125um, Duplex, 3M	320.00
	F-PC-OM2SCST5-3-DX	OM2, Patch Cord ST-SC, MM 50/125um, Duplex, 3M	320.00
	F-PC-OM2LCST5-3-DX	OM2, Patch Cord ST-LC, MM 50/125um, Duplex, 3M	320.00
	F-PC-OM2SCSC5-3-DX	OM2, Patch Cord SC-SC, MM 50/125um, Duplex, 3M	320.00
	F-PC-OM2LCSC5-3-DX	OM2, Patch Cord SC-LC, MM 50/125um, Duplex, 3M	320.00
	F-PC-OM2LCLC5-3-DX	OM2, Patch Cord LC-LC, MM 50/125um, Duplex, 3M	320.00
Patch Cord, OM3	F-PC-OM3STST5-3-DX	OM3, Patch Cord ST-ST, MM 50/125um, Duplex, 3M	340.00
	F-PC-OM3SCST5-3-DX	OM3, Patch Cord ST-SC, MM 50/125um, Duplex, 3M	340.00
	F-PC-OM3LCST5-3-DX	OM3, Patch Cord ST-LC, MM 50/125um, Duplex, 3M	340.00
	F-PC-OM3SCSC5-3-DX	OM3, Patch Cord SC-SC, MM 50/125um, Duplex, 3M	340.00
	F-PC-OM3LCSC5-3-DX	OM3, Patch Cord SC-LC, MM 50/125um, Duplex, 3M	340.00
	F-PC-OM3LCLC5-3-DX	OM3, Patch Cord LC-LC, MM 50/125um, Duplex, 3M	340.00
Patch Cord, OM4	F-PC-OM4LCSC5-3-DX	OM4, Patch Cord SC-LC, MM 50/125um, Duplex, 3M	380.00
	F-PC-OM4LCLC5-3-DX	OM4, Patch Cord LC-LC, MM 50/125um, Duplex, 3M	380.00
Patch Cord Push-Pull Tab	F-PC-F-PPLCLC5-3-DX	Patch Cord LC-LC, MM 50/125um, Push-Pull Tab, Duplex, 3M	500.00
	F-PC-F-PPLCSC5-3-DX	Patch Cord LC-SC, MM 50/125um, Push-Pull Tab, Duplex, 3M	500.00
	F-PC-F-PPSCSC5-3-DX	Patch Cord SC-SC, MM 50/125um, Push-Pull Tab, Duplex, 3M	500.00

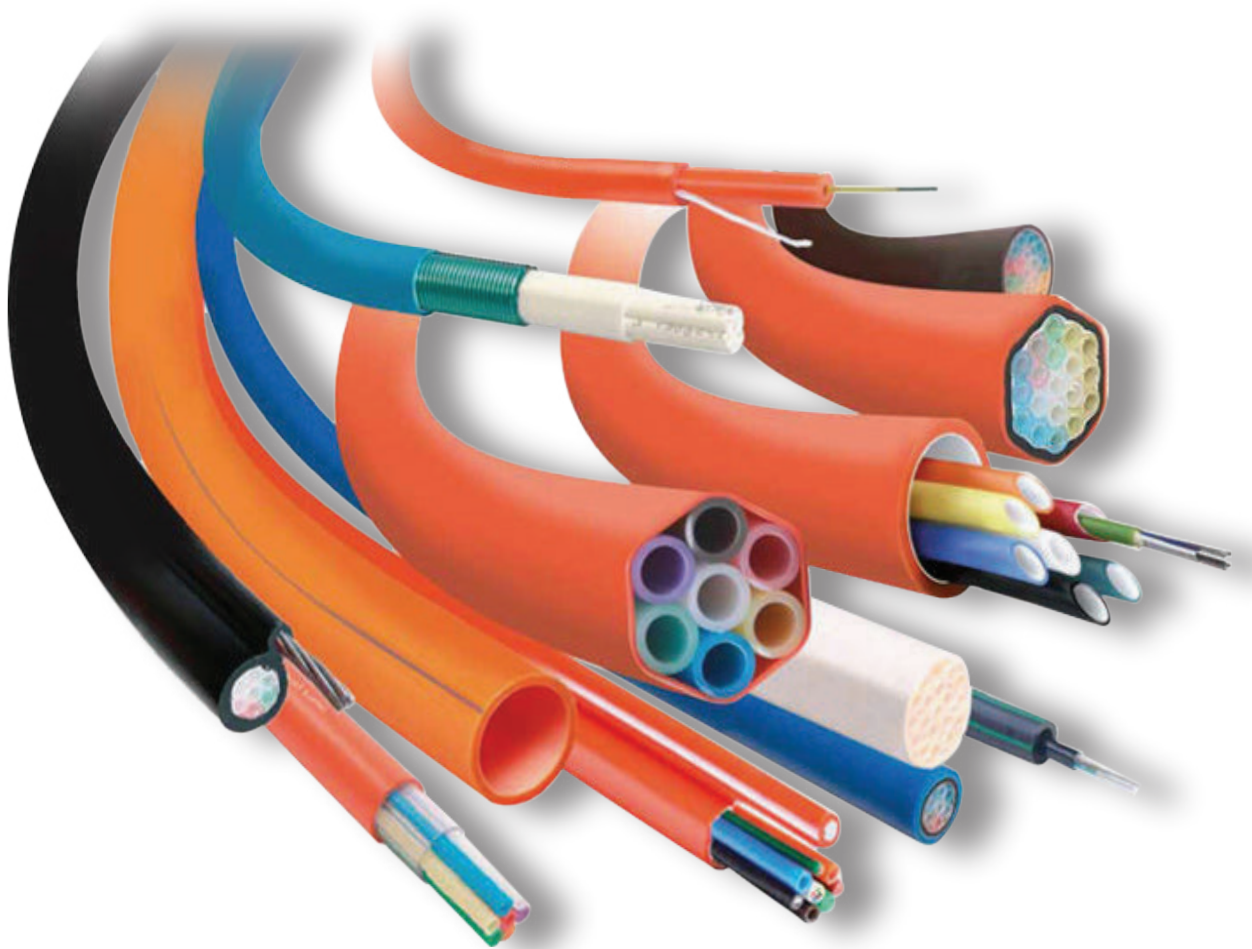

# Air Blown Fiber

- Micro Air Blown Fiber Cable
- Mini Air Blown Fiber Unit
- Tube Bundle
- Fiber Blown Fiber Accessorie



## Micro Air Blown Fiber Cable

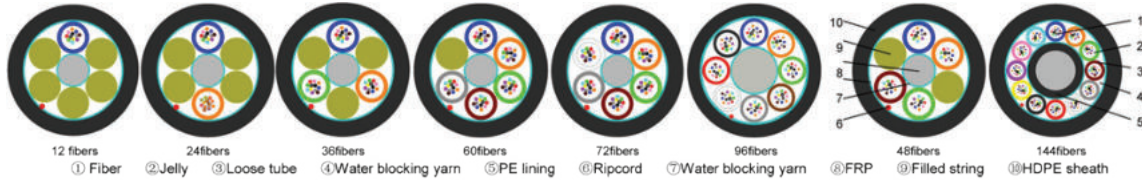

### INTRODUCTION

Air Blown Micro Cables are ultra lightweight with and small diameter and designed for metro feeder or access network to be blown into a micro duct by air-blown installation. As the cable allows the deployment of currently required fiber count, the micro cable provides a lower initial investment and the flexibility to install and upgrade to the latest fiber technologies after the initial installation.

## Mini Air Blown Fiber Unit

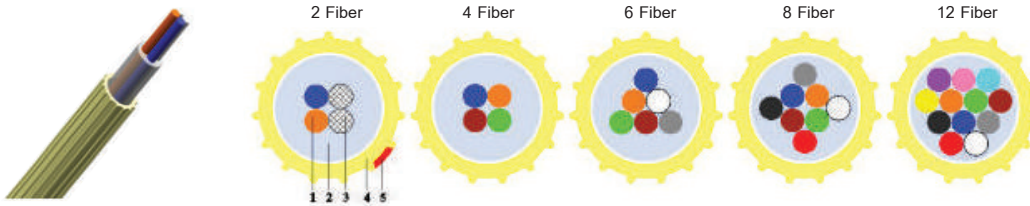

### INTRODUCTION

The EPFU is the product that with small diameter, lightweight, highly flexibility and proper stiffness, and it can be blown into the microduct of 5.0/3.5mm. The Fibers are coated with a soft acrylate resin which provides excellent dimensional and thermal stability to cushion the fibers; in addition, the resin can be easily stripped in connecting the Fibers. The outer sheath is a thermoplastic that is of low friction. The surface of the sheath is designed with special grooves, compared to the surface of the traditional optical fiber cable; it provides not only the high level of mechanical protection, but also the perfect blowing performance.

## Tube Bundle



### INTRODUCTION

Microtubules of high density polyethylene with high density polyethylene (HDPE) as the main raw material, using advanced plastic extrusion forming process made is lined on the inner wall of silicon material composite pipe, the pipe wall is a permanent solid lubricating layer, with self lubricity, effectively reduce the cable in the pipeline repeated extraction between the cable and pipe friction resistance. Application of micro pipe products, combined with micro optical cable and gas blowing technology, so that the communication cable pipe network construction has become flexible, economical and efficient, and to solve the problem of pipeline resource pipe hole tension and once again.

### ORDERING TABLE

PRODUCT	PART NUMBER	DESCRIPTION	PRICE
Micro Air Blown Fiber Cable	F-ABFM-12	Micro Air Blown Fiber Cable 12 Core	Call
	F-ABFM-24	Micro Air Blown Fiber Cable 24 Core	Call
	F-ABFM-36	Micro Air Blown Fiber Cable 36 Core	Call
	F-ABFM-48	Micro Air Blown Fiber Cable 48 Core	Call
	F-ABFM-60	Micro Air Blown Fiber Cable 60 Core	Call
	F-ABFM-72	Micro Air Blown Fiber Cable 72 Core	Call
	F-ABFM-96	Micro Air Blown Fiber Cable 96 Core	Call
	F-ABFM-144	Micro Air Blown Fiber Cable 144 Core	Call
Mini Air Blown Fiber Unit	F-ABF-01	Air Blown Fiber Unit 1 core G652D	Call
	F-ABF-02	Air Blown Fiber Unit 2 core G652D	Call
	F-ABF-04	Air Blown Fiber Unit 4 core G652D	Call
	F-ABF-06	Air Blown Fiber Unit 6 core G652D	Call
	F-ABF-08	Air Blown Fiber Unit 8 core G652D	Call
	F-ABF-12	Air Blown Fiber Unit 12 core G652D	Call
Tube Bundle	F-ABFD-7/3.5-01-1.2	HDPE Tube Bundle 7/3.5mm - 1Way PE1.2mm	Call
	F-ABFD-7/3.5-02-1.2	HDPE Tube Bundle 7/3.5mm - 2Way PE1.2mm	Call
	F-ABFD-7/3.5-04-1.2	HDPE Tube Bundle 7/3.5mm - 4Way PE1.2mm	Call
	F-ABFD-7/3.5-07-1.2	HDPE Tube Bundle 7/3.5mm - 7Way PE1.2mm	Call
	F-ABFD-10/8-01-3.4	HDPE Tube Bundle 10/8mm - 1Way PE3.4mm	Call
	F-ABFD-10/8-04-3.4	HDPE Tube Bundle 10/8mm - 4Way PE3.4mm	Call
	F-ABFD-10/8-07-1.7	HDPE Tube Bundle 10/8mm - 7Way PE1.7mm	Call
	F-ABFD-10/8-07-3.4	HDPE Tube Bundle 10/8mm - 7Way PE3.4mm	Call
	F-ABFD-12/10-04-1.7	HDPE Tube Bundle 12/10mm - 4Way PE1.7mm	Call
	F-ABFD-12/10-07-1.7	HDPE Tube Bundle 12/10mm - 7Way PE1.7mm	Call

# Accessories For Air Blown Fiber Product



Straight Microduct Connectors



End Stop Microduct Connectors



Locking Clips



DBC Cover



End Caps



Micro Duct Closure Y-branch



Micro Duct Closure T-branch



Tube Distribution Closure

## Ordering Table

PRODUCT	PART NUMBER	DESCRIPTION	PRICE
Straight Microduct Connectors	F-FSC5/3.5	5mm(3.5mm bore)Straight Connector	Call
	F-FSC7/3.5	7mm(3.5mm bore)Straight Connector	Call
	F-FSC10/8	10mm(8mm bore)Straight Connector	Call
	F-FSC12/10	12mm(10mm bore)Straight Connector	Call
End Stop Microduct Connectors	F-FED3	3mm End Stop	Call
	F-FED8	8mm End Stop	Call
	F-FED10	10mm End Stop	Call
Locking Clips	F-VB8mm	8mm Locking Clips	Call
	F-VB10mm	10mm Locking Clips	Call
DBC Cover	F-DBC8mm	8mm DBC Cover	Call
	F-DBC10mm	10mm DBC Cover	Call
End Caps	F-Y-type closure	8mm End Caps	Call
	F-T-type closure	10mm End Caps	Call
Micro Duct Closure	F-CST8	Y-branch (40,32,25,20mm)	Call
	F-CST10	T-branch (40,32,25,20mm)	Call
Tube Distribution Closures	F-I-Enclosure	Tube distribution closures (50mm)	Call



## Fiber Air Blown Solution

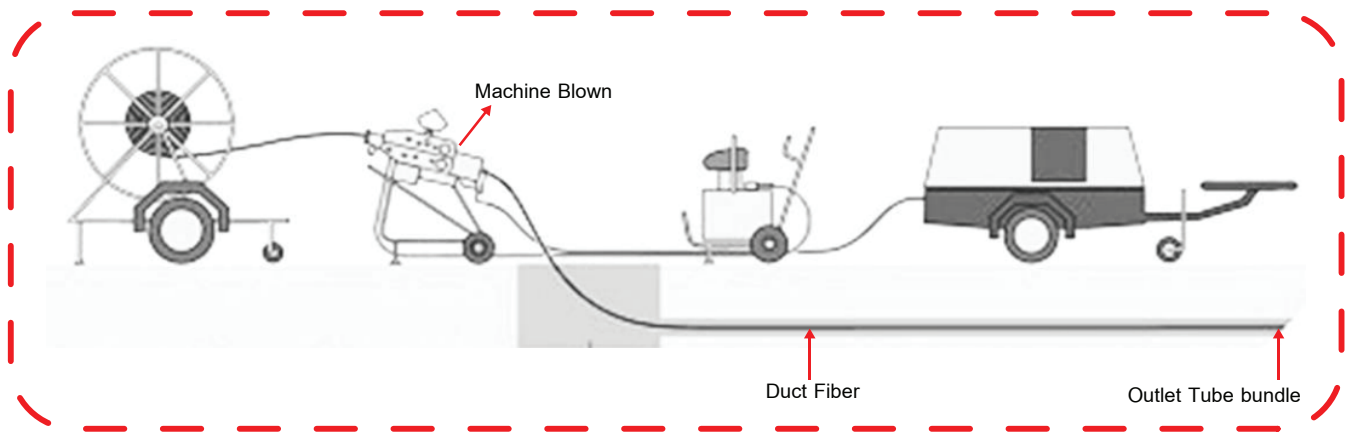
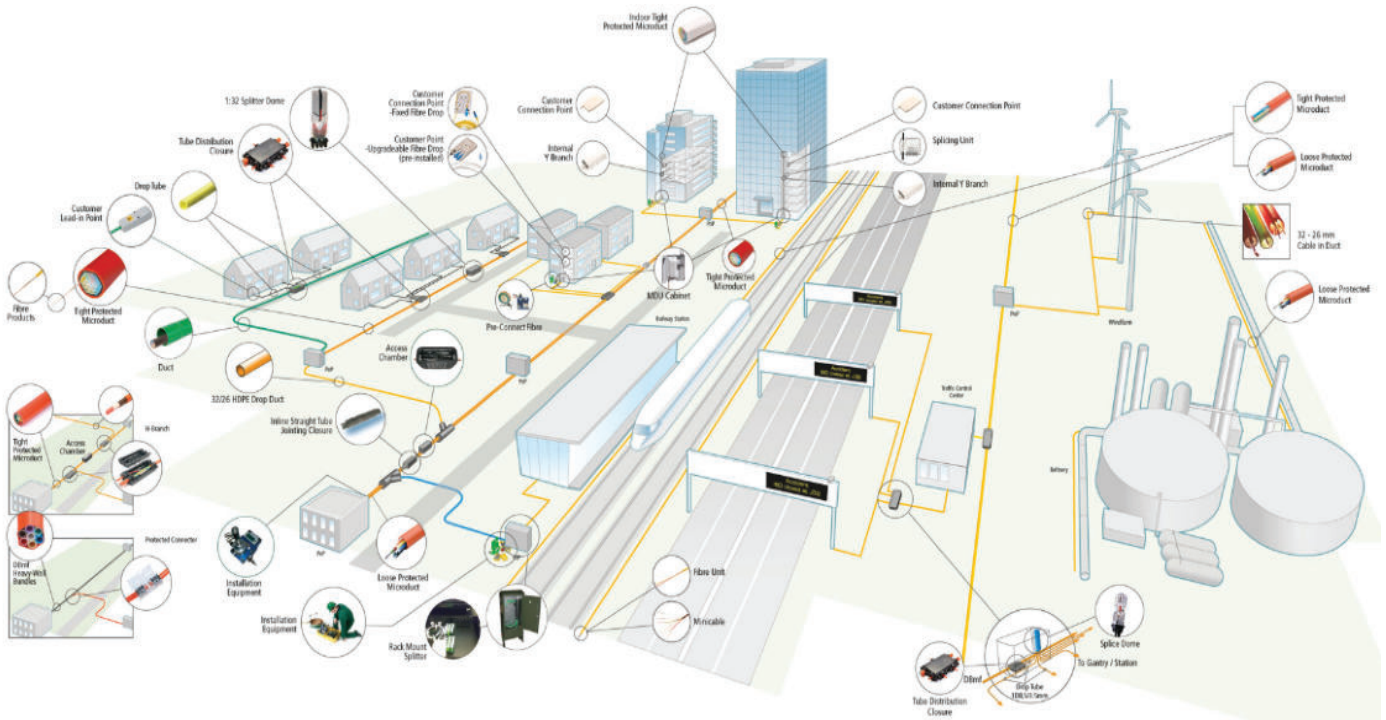

### Fiber Air Blown

Air Blown Fiber คือวิธีการติดตั้งเคเบิลใยแก้วโดยอาศัยลมในการช่วยดันให้เคเบิลใยแก้วเคลื่อนตัวไปตามท่อ (Micro Duct) จาก ต้นทาง ไปยังปลายทาง ข้อดี ในการใช้งาน Solution Fiber Air Blown

- ลดค่าใช้จ่ายในระยะยาว
- ง่ายในการออกแบบ และ วางแผน
- ง่ายในการอ็อปเกรดเครือข่ายในอนาคต การเพิ่มเติมเคเบิลใยแก้วมีผลต่อเครือข่ายที่ใช้งานอยู่น้อยมาก เคเบิลขนาดต่างๆสามารถเพิ่มเข้าไปในโครงสร้างได้เมื่อต้องการ
- ลดขนาดของเคเบิลที่ไม่ใช้งานให้น้อยลง ติดตั้งขนาดของเคเบิลตามความต้องการที่แท้จริง
- ลดจุดตัดต่อเคเบิล ตามเส้นทางส่วนใหญ่จะไม่มีจุดตัดต่อเคเบิลเลย
- ลดกำลังคนในการติดตั้ง
- มีความยืดหยุ่นในการออกแบบและใช้งาน ตัวท่อ (Micro Duct) สามารถแก้ไขเปลี่ยนแปลง และเพิ่มเส้นทางใหม่เข้าไปในเครือข่ายได้ง่าย โดยไม่ต้องมีการตัดต่อเคเบิล ทำให้ลดค่า Loss ลง
- ลดการขุดวางและติดตั้งเครือข่ายลง



# RG Cable Product

- RG Cable Indoor
- RG Cable Outdoor
- BNC
- Balun



## RG Cable Indoor

### RG6 Indoor CCTV Cable



**RG6-IB96**  
RG6 Cable, white, Coverage 96%,  
Braid Shield aluminum 0.16mm x 144 wire



**RG6-IB96-P**  
RG6 Cable, white, Coverage 96%, Power wire

### RG11 Indoor Main CCTV Cable



**RG11-IW-90**  
RG11 Cable, white, Coverage 90%,  
Braid Shield aluminum 0.16mm x 168 wire

## RG Cable Outdoor

### RG6 Outdoor CCTV Cable



**RG6-OB96**  
RG6 Cable, Coverage 96%,  
Braid Shield aluminum 0.16mm x 144 wire



**RG6-OB96-P**  
RG6 Cable, Coverage 96%,  
Braid Shield aluminum 0.16mm x 144 wire,  
Power wire

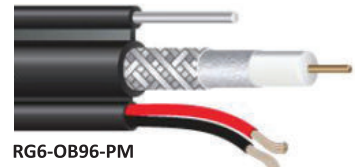

**RG6-OB96-PM**  
RG6 Cable, Coverage 96%,  
Braid Shield aluminum 0.16mm x 144 wire,  
Power wire, Messenger

### RG11 Outdoor Main CCTV Cable



**RG11-OB-90**  
RG11 Cable, Coverage 90%,  
Braid Shield aluminum 0.16mm x 168 wire, Messenger

## Ordering Table

PRODUCT	PART NUMBER	DESCRIPTION	PRICE
RG6 Indoor CCTV	RG6-IB96	RG6 Cable, white, Coverage 96%, Braid Shield aluminum 0.16mm x 144 wire, 500m/Roll	3,800.00
	RG6-IB96-P	RG6 Cable, white, Coverage 96%, Power wire, 500m/Roll	7,000.00
RG11 Indoor Main CCTV	RG11-IW-90	RG11 Cable, white, Coverage 90%, Braid Shield aluminum 0.16mm x 168 wire, 500m/Roll	7,500.00
RG6 Outdoor CCTV 100M	RG6-OB96-100	RG6 Cable, Coverage 96%, Braid Shield aluminum 0.16mm x 144 wire, 100m/Roll	800.00
	RG6-OB96-100M	RG6 Cable, Coverage 96%, Braid Shield aluminum 0.16mm x 144 wire, Messenger, 100m/Roll	900.00
	RG6-OB96-100P	RG6 Cable, Coverage 96%, Braid Shield aluminum 0.16mm x 144 wire, Power wire, 100m/Roll	1,000.00
RG6 Outdoor CCTV 300M	RG6-OB96-300	RG6 Cable, Coverage 96%, Braid Shield aluminum 0.16mm x 144 wire, 300m/Roll	2,400.00
	RG6-OB96-300M	RG6 Cable, Coverage 96%, Braid Shield aluminum 0.16mm x 144 wire, Messenger, 300m/Roll	2,800.00
	RG6-OB96-300P	RG6 Cable, Coverage 96%, Braid Shield aluminum 0.16mm x 144 wire, Power wire, 300m/Roll	3,300.00
RG6 Outdoor CCTV 500M	RG6-OB96-500	RG6 Cable, Coverage 96%, Braid Shield aluminum 0.16mm x 144 wire, 500m/Roll	4,000.00
	RG6-OB96-500M	RG6 Cable, Coverage 96%, Braid Shield aluminum 0.16mm x 144 wire, Messenger, 500m/Roll	4,500.00
	RG6-OB96-500P	RG6 Cable, Coverage 96%, Braid Shield aluminum 0.16mm x 144 wire, Power wire, 500m/Roll	5,400.00
RG11 Outdoor Main CCTV	RG11-OB-90-500	RG11 Cable, Coverage 90%, Braid Shield aluminum 0.16mm x 168 wire, Messenger, 500m/Roll	8,000.00



# Accessories For RG Cable Product



## BNC



BNC male connector, crimp type



BNC Plug RG11 (male)



Female BNC to BNC Female Connector



BNC "T" Connector (1 male to 2 female)



BNC "T" Connector (3 female)



BNC male to F female connector



BNC male to screw terminal connector



2,1/5,5mm dc female to screw terminal connector



2,1/5,5mm dc male to screw terminal connector

## Balun

CCTV camera 2MP video balun cctv products



### Features

- AHD : 720P 300M/960P 300M/1080P : 150M
- HDCVI : 720P 300M/1080P 150M
- HDTVI : 720P 200M/1080P 100M

HD Video Balun For HD-CVI /TVI /AHD



### Features

- No power required, simplified project wiring
- Compatible with HDCVI/HCTVI/AHD
- Anti-interference, suprt lighting protection, ESD

### Ordering Table

PRODUCT	PART NUMBER	DESCRIPTION	PRICE
BNC	BNC-RG6MC	BNC RG6 male connector, crimp type	14.00
	BNC-RG6M	BNC RG6 male connector	8.00
	BNC-RG11M	BNC Plug RG11 (male)	20.00
	BNC-FMFM	Female BNC to BNC Female Connector	13.00
	BNC-RG6MFF	BNC "T" Connector (1 male to 2 female)	20.00
	BNC-RG6FFF	BNC "T" Connector (3 female)	20.00
	BNC-RG6MFF	BNC male to F female connector	18.00
	BNC-RG6T	BNC male to screw terminal connector	15.00
	DCF-T	2,1/5,5mm dc female to screw terminal connector	10.00
	DCM-T	2,1/5,5mm dc male to screw terminal connector	10.00
Balun	BNC-BL-2MP	CCTV camera 2MP video balun cctv products	70.00
	BNC-BL-5MP	CCTV Accessories 1080P 4MP 5MP Passive HD Video Balun For HD-CVI /TVI /AHD	105.00



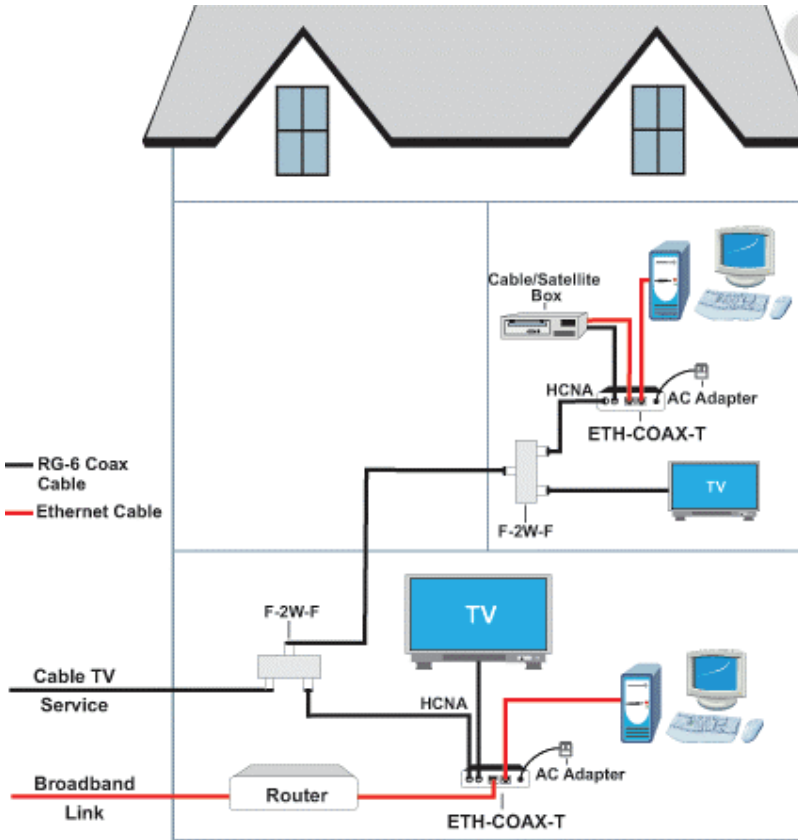

### การเลือกใช้งานของสาย Coaxial Cable

ปัจจุบันมีสายสัญญาณออกมาหลายรูปแบบมีทั้งได้คุณภาพและไม่มีคุณภาพดังนั้นเราต้องควรศึกษาและใช้วิจารณญาณในการเลือกใช้สัญญาณที่ใช้กันส่วนใหญ่จะมี สาย RG-6 และ RG-11 ในการเลือกสาย RG-6 มีหลักใหญ่ๆดังนี้คือ

#### การสังเกตด้วยตา

- แกนทองแดงนั้นจะต้องอยู่จุดศูนย์กลางระหว่างโฟมและจะต้องโตไม่น้อยกว่า 1-1.1 มม.
- อลูมิเนียมฟลอยด์ที่เคลือบป้องกันสัญญาณรบกวนต้องเป็นอลูมิเนียมแท้และเมื่อใช้โอมมิเตอร์ตั้งย่าน RX1 วัดลงอลูมิเนียมจะต้องขึ้นและมีค่าความต้านทานคงที่ด้วย
- เนื้อโฟมจะต้องมีสีขาวและยืดหยุ่นได้ เมื่อมีปลอกออกมาจะต้องไม่มีโฟมติดกับแกนทองแดงเลยการใช้เครื่องมือวัดทดสอบ
- การใช้เครื่องมือวัดจะต้องมีสเปคของสายที่ต้องการทดสอบก่อน จากนั้นวัดค่าอินพุตและบันทึกค่าไว้ เปรียบเทียบกับค่าสัญญาณเมื่อผ่านสายที่ต้องการจะทดสอบว่ามีค่าสูญเสียเท่ากันหรือน้อยกว่าสเปคก็ใช้ได้
- การใช้เครื่องมือวิเคราะห์สัญญาณ (สเปคตรัมอานาไลเซอร์) การใช้เครื่องมือชนิดนี้จะมีประสิทธิภาพในการเช็คมากกว่าแบบแรกโดยดูจากสัญญาณตลอดย่านความถี่นั้นว่ามีปัญหาหรือไม่รวมถึงค่าอิมพีแดนซ์และ VSWR สามารถบอกได้ทันทีว่าสายมีคุณภาพมากน้อยเพียงใด

### COAXIAL CABLE RG6

#### ATTENUATOR (68Degrees F(20Degees c)

FREQUENCY (MHz)	COXIAL CABLE RG6/U	
	dB/100ft	dB/100m
5	0.8	1.9
55	1.6	5.25
211	3.05	10
250	3.3	10.82
350	3.85	12.63
400	4.15	13.61
450	4.4	14.43
500	4.66	15.09
550	4.9	16.08
600	5.1	16.73
750	5.65	18.54
865	6.1	20.01
1000	6.55	21.49
1200	7.29	23.89
1450	8.02	26.3
1750	8.88	19.13
2040	10.35	33.94

### COAXIAL CABLE RG11

#### ATTENUATOR (68Degrees F(20Degees c)

FREQUENCY (MHz)	COXIAL CABLE RG6/U	
	dB/100ft	dB/100m
5	0.38	1.25
55	0.96	3.15
211	1.9	6.23
250	2.05	6.72
350	2.42	7.94
400	2.6	8.53
450	2.75	9.02
500	2.9	9.51
550	3.04	9.97
600	3.18	10.43
750	3.65	11.97
865	3.98	13.05
1000	4.35	14.27
1200	4.84	15.85
1450	5.42	17.78
1750	6.1	20.01
2040	7.11	23.33



# HDMI PRODUCT

- HDMI Cable
- HDMI Over IP Extender
- HDMI Splitter



## HDMI Cable



HDMI device supports HD resolution will reach 4KX2K, four times the current 1080P. The specific format: 380X2160 24Hz/25Hz/30Hz; 4096X2160 24Hz.

### Features

- Support 3D and max resolution up to 4K@60hz 4:4:4
- Supports Highest Refresh Rates up to 240hz and 48-Bit Deep Color
- Support data rate up to 18 Gbps, Support up to 32 audio channels
- Support simultaneous delivery of 2 video streams (Dual view) at the same time
- Supports True HD Dolby 7.1 and DTS-HD Master Audio, Supports Ethernet and Audio return channel (ARC)

## HDMI Switch

### VGA extender 120 meters



### Features

- Use the UTP Cat5e6 to transmit HDMI 1080P signals to 120 meters.
- By adding an Ethernet switch, it can transmit longer than 120 meters over the LAN network.
- Cat5e / 6/7 cable complies with IEEE-568B standard

### VGA +KVM(USB) extender 120 meters



### Features

- Through a CAT5E, CAT6 UTP cable can transmit one-way VGA video, stereo audio
- CAT5E, CAT6 UTP cable transmission distance up to 120m
- The device supports VGA, Audio Interface
- Support for KVM, USB mouse and keyboard to remotely control

## DVI Extender

### DVI extender 120 meters



### Features

- Via a CAT5e, CAT6 UTP cable can transmit one-way DVI video, stereo audio
- Support for up to DVI resolution up to 1080P / 60HZ
- CAT5E, CAT6 UTP cable transmission distance up to 120 meters
- The device supports DVI, Audio Interface

### DVI +KVM(USB) extender 120 meters



### Features

- Through a CAT5E, CAT6 UTP cable can transmit one-way DVI video, stereo audio
- Support for up to DVI resolution up to 1080P / 60HZ
- CAT5E, CAT6 UTP cable transmission distance up to 120m
- Support for KVM, USB mouse and keyboard to remotely control

## Coax EOC Extender

### 1,2 CH Ethernet Extender over coax LAN Network converter



### Features

- Interface: BNC interface 1, 2 CH RJ45 interface\*1
- Transmission Rate: maximum 100Mbps
- Maximum Transmission Range: 2KM
- Power Supply: DC12V1A (Can share a power supply with a network IP camera)
- Transmission Frequency: 2M-30M

## Ordering Table

PRODUCT	PART NUMBER	DESCRIPTION	PRICE
HDMI Cable	H-HDMI4K-1	Gold Plated 4K HDMI cable 2.0 , 1.0M	120.00
	H-HDMI4K-1.5	Gold Plated 4K HDMI cable 2.0 , 1.5M	150.00
	H-HDMI4K-2	Gold Plated 4K HDMI cable 2.0 , 2.0M	180.00
	H-HDMI4K-3	Gold Plated 4K HDMI cable 2.0 , 3.0M	240.00
	H-HDMI4K-5	Gold Plated 4K HDMI cable 2.0 , 5.0M	300.00
	H-HDMI4K-7	Gold Plated 4K HDMI cable 2.0 , 7.0 M	360.00
	H-HDMI4K-10	Gold Plated 4K HDMI cable 2.0 , 10M	450.00
	H-HDMI4K-15	Gold Plated 4K HDMI cable 2.0 , 15 M	900.00
	H-HDMI4K-20	Gold Plated 4K HDMI cable 2.0 , 20 M	1,500.00
VGA Extender	H-VGA-EX-120	VGA extender 120 meters	Pair 3,500.00
	H-VGA-KVM-EX-120	VGA +KVM(USB) extender 120 meters	Pair 4,200.00
DVI Extender	H-DVI-EX-120	DVI extender 120 meters	Pair 4,550.00
	H-DVI-KVM-EX-120	DVI +KVM(USB) extender 120 meters	Pair 6,300.00
Coax EOC Extender	H-EOC-IP-1CH	1-CH Ethernet Extender over coax LAN Network converter	1,400.00
	H-EOC-IP-2CH	2-CH Ethernet Extender over coax LAN Network converter	1,600.00

## HDMI OVER IP EXTENDER

### HDMI extender 50 meters



#### Features

- Long range transmission: up to 60m/196ft over a single CAT6 cable
- Video resolution: Up to 1920x1080P@60Hz
- Video standard: compliance with HDMI 1.3 and HDCP 1.2 standard

### HDMI with IR extender 50 meters



#### Features

- Long range transmission: up to 60m/196ft over a single CAT6 cable
- Video resolution: Up to 1920x1080P@60Hz
- Infrared control: Bi-directional 38 KHz IR remote control

### HDMI extender 120 meters



#### Features

- Support resolution up to 1080p full HD
- 120m HDMI extender use single cat5 or cat-6
- Cat5e / 6/7 cable complies with IEEE-568B standard

### HDMI +KVM(USB) extender 120 meters



#### Features

- Transfer the HDMI 1080P signal to 120 meters using the UTP Cat5e6.
- With KVM function
- Cat5e / 6/7 cable complies with IEEE-568B standard

### Ordering Table

### HDMI with Loop out extender 50 meters



#### Features

- Long range transmission: up to 60m/196ft over a single CAT6 cable
- Video resolution: Up to 1920x1080P@60Hz
- HDMI loop out function: The transmitter with one HDMI local loop out

### HDMI with IR Loop out extender 50 meters



#### Features

- Long range transmission: up to 60m/196ft over a single CAT6 cable
- Video resolution: Up to 1920x1080P@60Hz
- HDMI loop out function: The transmitter with one HDMI local loop out

### HDMI with IR extender 120 meters



#### Features

- Support resolution up to 1080p full HD
- 120m HDMI extender use single cat5 or cat-6
- Cat5e / 6/7 cable complies with IEEE-568B standard

## HDMI Switch

### Quad multi-viewer 4 X 1 HDMI switch 4 port



#### Features

- Support 4HDMI input, 1 HDMI output
- Quad multi-viewer 4 X 1 HDMI switch 4 port, seamless switcher and infrared remote support 1080P HDMI 1.3 A

PRODUCT	PART NUMBER	DESCRIPTION	PRICE
HDMI OVER IP EXTENDER	H-HDMI-EX-50	HDMI extender 50 meters	Pair 2,500.00
	H-HDMI-EX-LP-50	HDMI with Loop out extender 50 meters	Pair 3,000.00
	H-HDMI-EXIR-50	HDMI with IR extender 50 meters	Pair 3,000.00
	H-HDMI-EXIR-LP-50	HDMI with IR Loop out extender 50 meters	Pair 3,500.00
HDMI with IR extender 120 meters	H-HDMI-EX-120	HDMI extender 120 meters	Pair 5,000.00
	H-HDMI-EXIR-120	HDMI with IR extender 120 meters	Pair 5,500.00
	H-HDMI-KVM-EX-120	HDMI +KVM(USB) extender 120 meters	Pair 8,000.00
HDMI Switch	H-HDMI-ST-04	Quad multi-viewer 4 X 1 HDMI switch 4 port	5,500.00



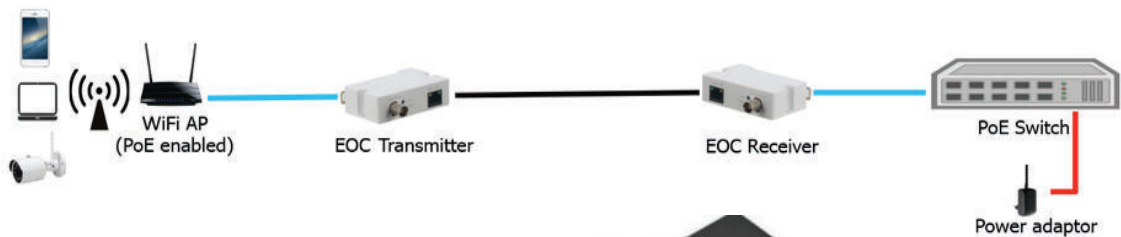
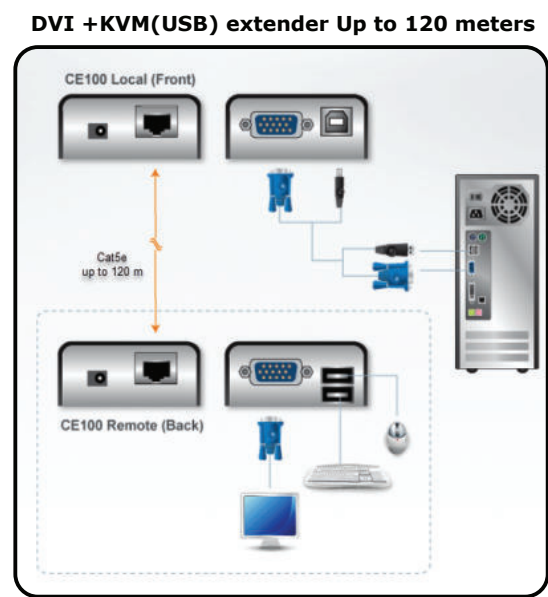
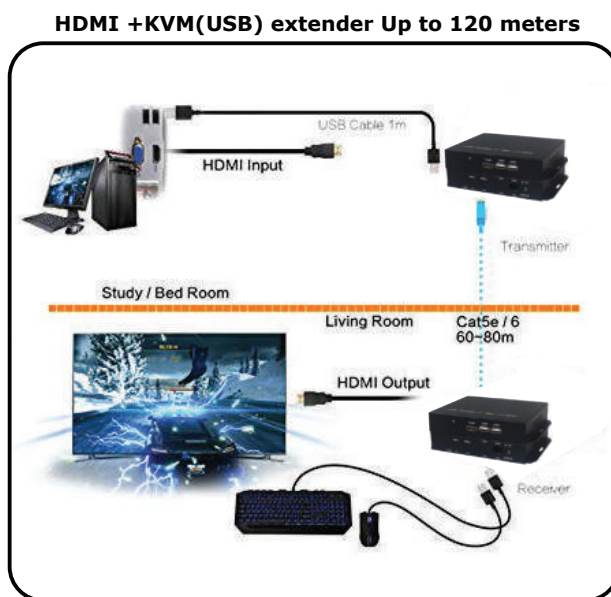
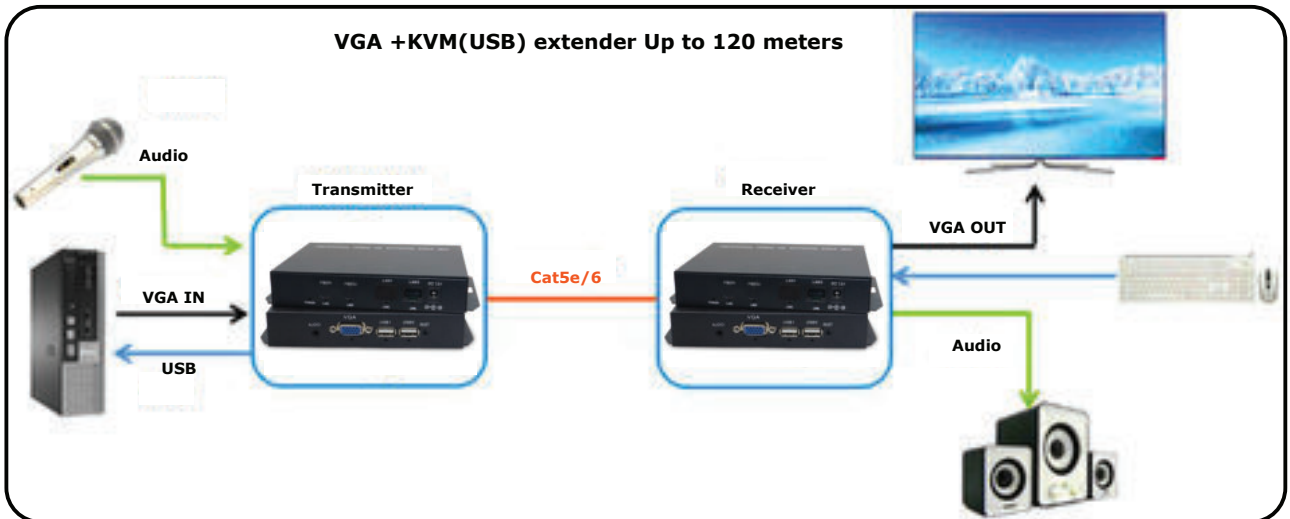

### Product Focomm

EOC Ethernet over coax converter

- รองรับเครือข่ายหลายโหนดและสามารถเชื่อมต่อสายเคเบิลได้ไปยังอุปกรณ์ปลายทางได้สูงสุด 24 เครื่อง
- รองรับ 720P, 960P และ 1080P HD IP เครือข่ายกล้อง



EOC

### เกร็ดความรู้

คืออุปกรณ์ที่ใช้สำหรับควบคุมหรือทำให้เราสามารถใช้งานคอมพิวเตอร์ได้มากกว่า 1 เครื่องในเวลาพร้อมกัน ซึ่งเป็นอุปกรณ์ที่สามารถทำให้คีย์บอร์ด จอ เมาส์ เพียง 1 ชุด ก็สามารถใช้งานได้กับเครื่องหลายเครื่อง เป็นการช่วยประหยัดพื้นที่ในการติดตั้ง เพราะไม่ต้องต่อ Monitor แบบหนึ่งต่อหนึ่ง โดยในทางศัพท์วงการ PC ใช้เรียกว่าระบบ KVM Switch หรืออุปกรณ์ที่ใช้สลับสัญญาณนั่นเอง ซึ่งตัว KVM ก็จะมีหลากหลายประเภท ยกตัวอย่างเช่น KVM ประเภทที่มีสาย Cable ติดมากับกล่อง, KVM ประเภทที่ติดตั้งเข้ากับ Rack, KVM ประเภทที่เชื่อมต่อกับสายแลน Cat5, KVM ประเภทที่มีกล่องเชื่อมต่อแยกต่างหาก เป็นต้น

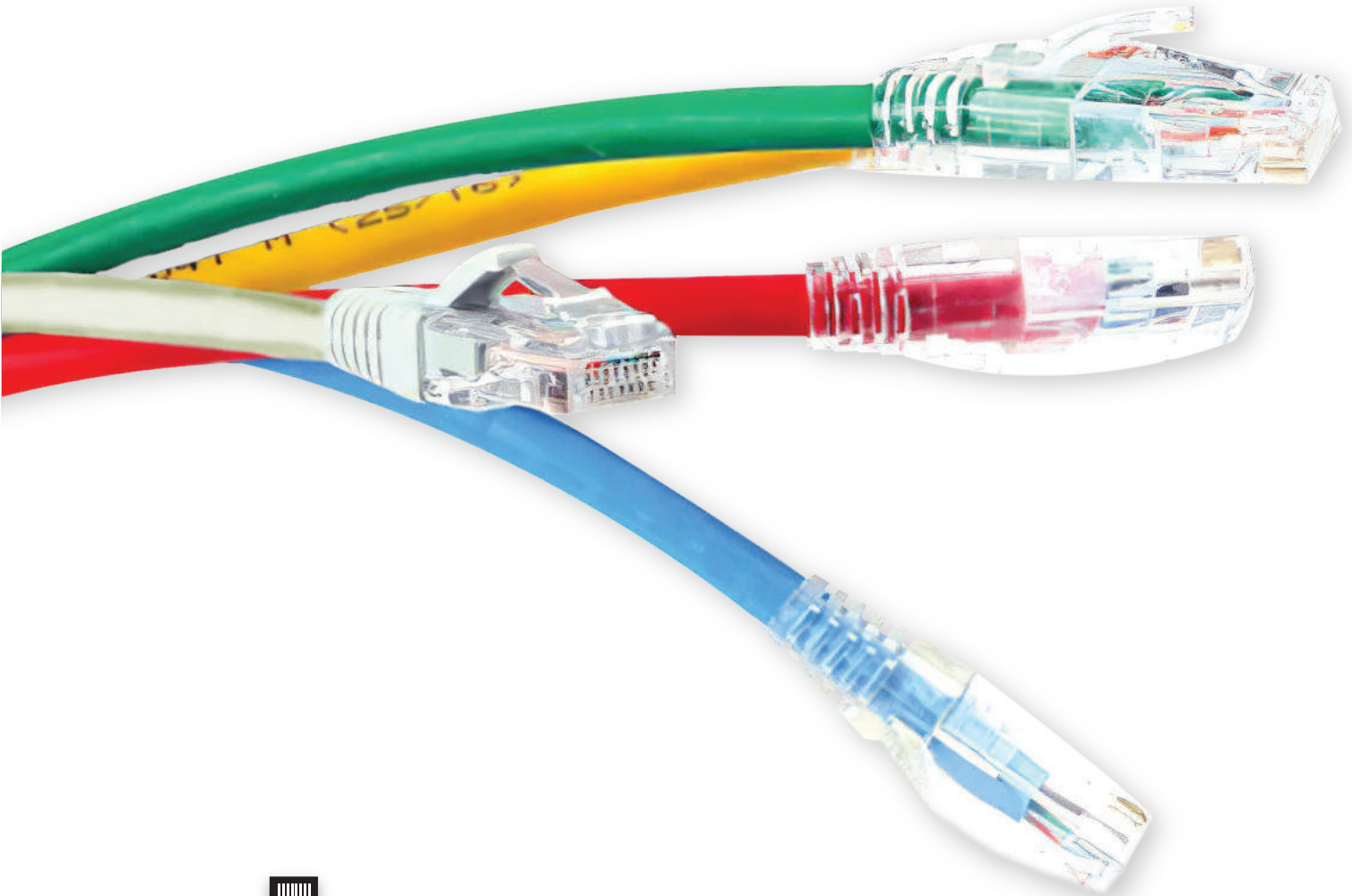

# UTP Cable Product

- UTP Cable Indoor
- UTP Cable Outdoor
- UTP Cable Outdoor Drop Wrie
- Patch Panel
- Patch Cord
- Keystone Jack
- Modular Plug and Boot
- Face Plate, Plug Boot



## LAN Cable Indoor

### CAT 6A



**L-UI6A-SJ-FTP**  
Cat6A F/UTP Cable 23AWG, 650MHz, LSZH

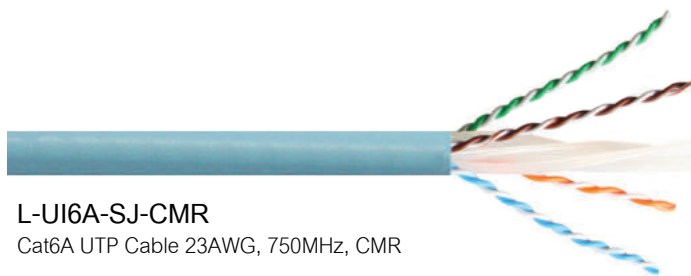
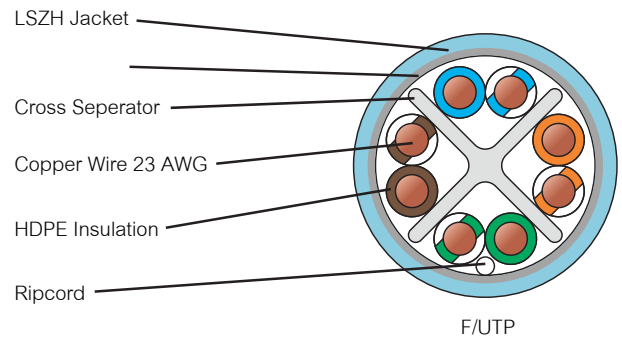

**L-UI6A-SJ-CMR**  
Cat6A UTP Cable 23AWG, 750MHz, CMR

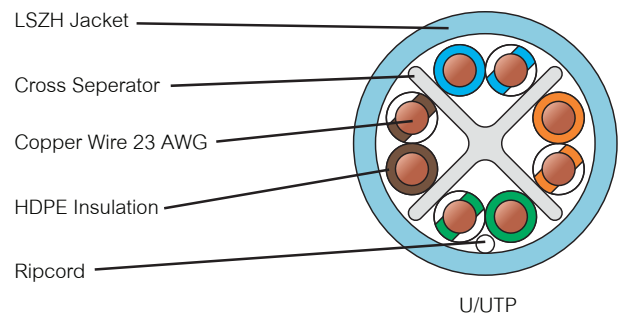

### CAT 6

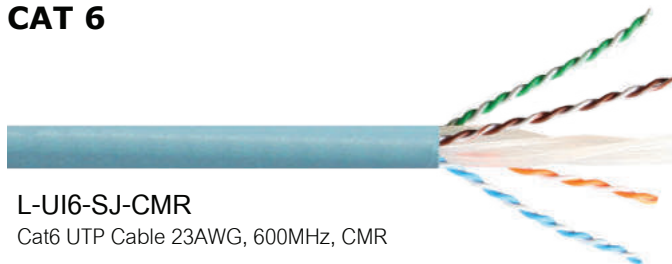

**L-UI6-SJ-CMR**  
Cat6 UTP Cable 23AWG, 600MHz, CMR

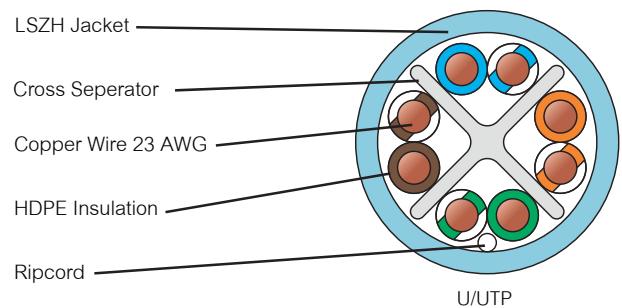

### CAT 5e

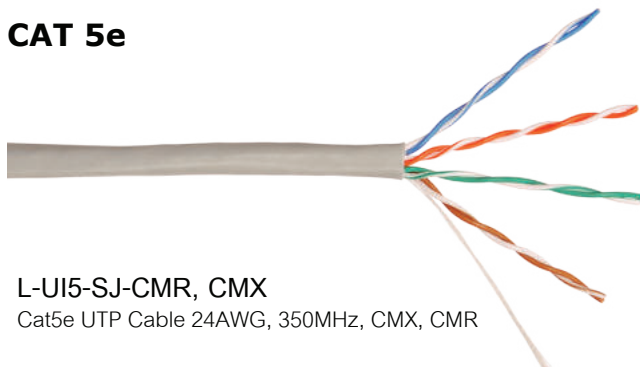

**L-UI5-SJ-CMR, CMX**  
Cat5e UTP Cable 24AWG, 350MHz, CMX, CMR

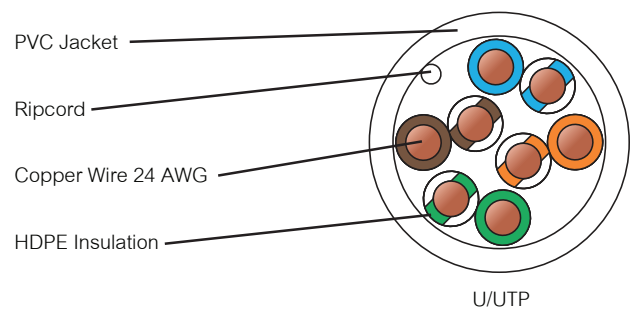

## Specification

Part number	L-UI6A-SJ-FTP-LSZH	L-UI6A-SJ-CMR	L-UI6-SJ-CMR	L-UI5-SJ-CMR / CMX
Category	6A		6	5e
Bandwidth (MHz)	650 MHz	750 MHz	600 MHz	350 MHz
Type of cable	F/UTP	U/UTP	U/UTP	
Number of pairs	4		4	
Conductor material	Copper		Copper	
Type of conductor	Solid		Solid	
Diameter of conductors	23AWG 0.58 ± 0.1 mm	23AWG 0.58 ± 0.1 mm	23AWG 0.55 ± 0.01 mm	24AWG 0.5 ± 0.01 mm
Material of conductor insulation	High Density Polyethylene (HDPE)		High Density Polyethylene (HDPE)	
Thickness of conductor insulation	0.310 ± 0.02 mm	0.326 ± 0.02 mm	0.21 ± 0.02 mm	0.20 ± 0.02 mm
Diameter of wire insulation	1.4 ± 0.05 mm	1.1 ± 0.05 mm	0.99 ± 0.05 mm	0.90 ± 0.05 mm
Material of ourter jacket	LSZH	PVC/CMR	PVC/CMR	PVC/CMR / PVC/CMX
Area of application	Indoor		Indoor	
Jacket Thickness	0.7 ± 0.05 mm		0.6 ± 0.05 mm	0.6 ± 0.05 mm
Outer diameter of jacket	7.4 ± 0.3 mm	7.1 ± 0.3 mm	6 ± 0.3 mm	5.1 ± 0.3 mm
Jacket color	Light Blue		Light Blue	White
Screen design	PES/Al foil, 100% coverage, paved with a solid drain wire	-	-	-
Protective film	-		-	
Ripcord	Yes		Yes	
Mass density (kg) per unit length (km)	57.8 ± 0.5 kg/km	50 ± 0.5 kg/km	40.2 ± 0.5 kg/km	29.8 ± 0.5 kg/km / 28.7 ± 0.5 kg/km
Min. bending radius during cabling	≥ 4x OD		≥ 4x OD	
Min. bending radius during opeartion	≥ 8x OD		≥ 8x OD	
Max. tensile strength, N	Max 100 N		Max 100 N	
Characteristic impedance, ohms	100 ± 15 ohms at 20°C		100 ± 15 ohms at 20°C	
Nominal velocity of propagation (NVP)	0.78 ± 0.1		0.69 ± 0.1	
Max. conductor resistance(DC)	≤ 82 ohms/km	≤ 82 ohms/km	≤ 89 ohms/km	≤ 94 ohms/km / ≤ 93.8 ohms/km
Compliance	ISO/IEC 11801, EN 50173 and ANSI/TIA-568-C.2, RoHS, REACH			
Application	10BASE-T, 100BASE-TX, 100BASE-T4, 1000BASE-T, 10GBASE-T (55 M) ATM-25, ATM-51, ATM-155, 100VG-AnyLan, TR-4, TR-16 Active, TR-16 Passive			
Temperature range	Storage -20 to +60°C. Installation from 0 to +50°C. Operating from -20 to +60°C			

## Ordering Table

Part Number	Pairs	Category	Type	Usage, Jacket	Color	Length, m	Package	PRICE
L-UI6A-SJ-FTP	4	6A	U/UTP	Indoor,FTP	Light Blue	305	Pull-out box	6,500.00
L-UI6A-SJ-CMR	4	6A	F/UTP	Indoor,CMR	Light Blue	305	Pull-out box	5,000.00
L-UI6-SJ-LSZH	4	6	U/UTP	Indoor,LSZH	Light Blue	305	Pull-out box	4,500.00
L-UI6-SJ-CMR	4	6	U/UTP	Indoor,CMR	Light Blue	305	Pull-out box	3,800.00
L-UI5-SJ-CMR	4	5e	U/UTP	Indoor,CMR	White	305	Pull-out box	2,700.00
L-UI5-SJ-CMX	4	5e	U/UTP	Indoor,CMX	White	305	Pull-out box	2,600.00



## LAN Cable Outdoor

### CAT 6

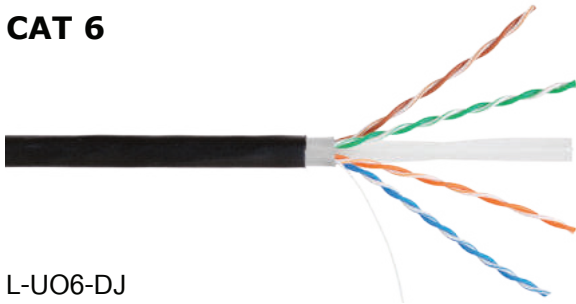

L-UO6-DJ

Cat6 UTP Cable, Outdoor Double Jacket, 23AWG, 600MHz

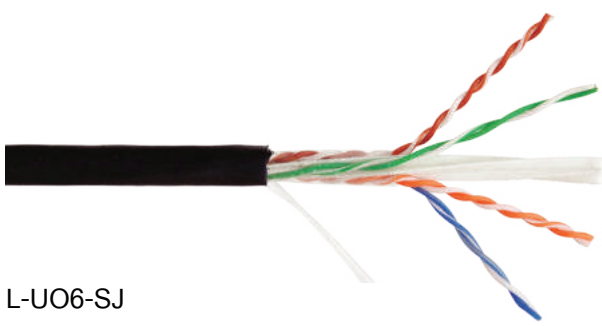
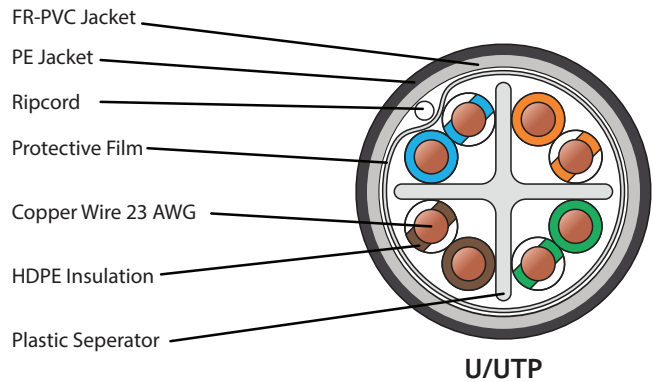

L-UO6-SJ

Cat6 UTP Cable, Outdoor Single Jacket, 23AWG, 600MHz

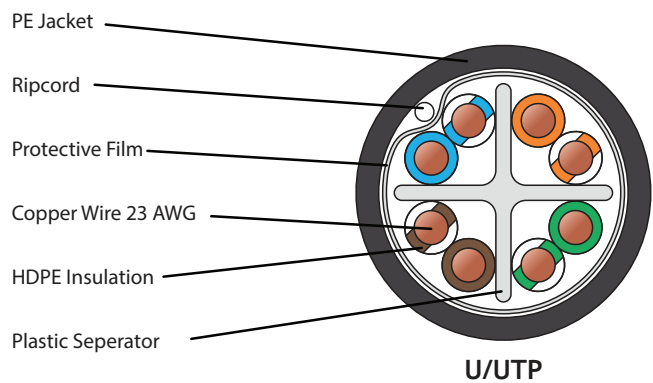

### CAT 5e

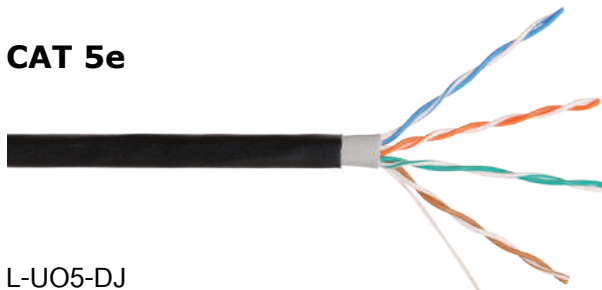

L-UO5-DJ

Cat5e UTP Cable, Outdoor Double Jacket, 24AWG, 350MHz

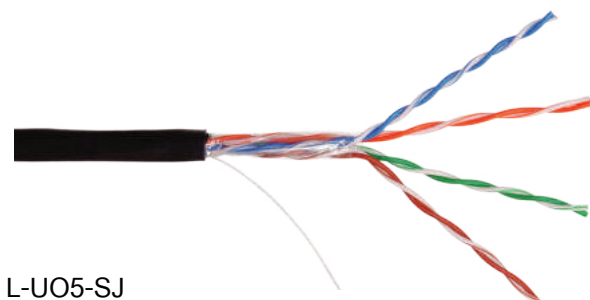
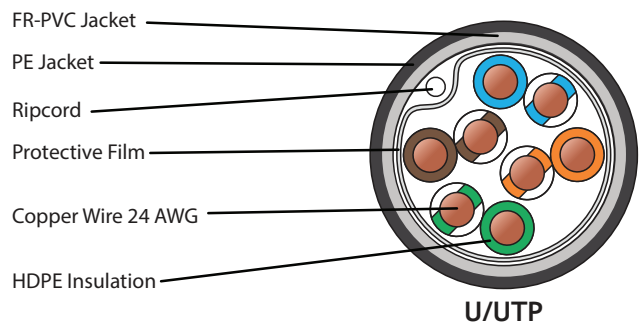

L-UO5-SJ

Cat5e UTP Cable, Outdoor Single Jacket, 24AWG, 350MHz

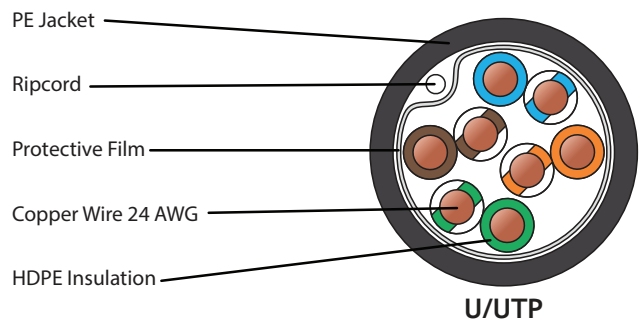

## Specification

Part number	L-UO6-DJ	L-UO6-SJ	L-UO5-DJ	L-UO5-SJ
Category	6		5e	
Bandwidth (MHz)	600 MHz		350 MHz	
Type of cable	U/UTP		U/UTP	
Number of pairs	4			
Conductor material	Copper			
Type of conductor	Solid			
Diameter of conductors	0.57 ± 0.01 mm		0.50 ± 0.01 mm	
Material of conductor insulation	High Density Polyethylene (HDPE)			
Thickness of conductor insulation	0.25 ± 0.02 mm	0.25 ± 0.02 mm	0.25 ± 0.02 mm	0.2 ± 0.02 mm
Diameter of wire insulation	1.09 ± 0.05 mm	1.09 ± 0.05 mm	1 ± 0.05 mm	0.9 ± 0.05 mm
Outer jacket Material	PE			
Inner Jacket material	FR-PVC	-	FR-PVC	-
Usage	Outdoor			
Out Jacket Thickness	0.6 ± 0.05 mm		0.55 ± 0.05 mm	
Inner Jacket Thickness	0.6 mm			
Outer diameter of jacket	6.8 ± 0.3 mm	6.1 ± 0.3 mm	6.6 ± 0.3 mm	5.3 ± 0.3 mm
Jacket color	Black			
Protective film	Polyester			
Ripcord	Yes			
Mass density (kg) per unit length (km)	43.1 ± 0.5 kg/km	37.8 ± 0.5 kg/km	35.1 ± 0.5 kg/km	26.7 ± 0.5 kg/km
Min. bending radius during cabling	≥ 4x OD			
Min. bending radius during operation	≥ 8x OD			
Max. tensile strength, N	Max 100 N			
Characteristic impedance, ohms	100 ± 15 ohms at 20°C			
Nominal velocity of propagation (NVP)	0.70 ± 0.1	0.69 ± 0.1	0.69 ± 0.1	0.69 ± 0.1
Max. conductor resistance(DC)	95 ohms/km			
Compliance	ISO/IEC 11801, EN 50173 and ANSI/TIA-568-C.2, RoHS, REACH			
Application	10BASE-T, 100BASE-TX, 100BASE-T4, 1000BASE-T, 10GBASE-T (55 M) ATM-25, ATM-51, ATM-155, 100VG-AnyLan, TR-4, TR-16 Active, TR-16 Passive			
Temperature range	Storage -60 to +60°C. Installation from 10 to +50°C. Operating from -60 to +60°C			

## Ordering Table

Part Number	Pairs	Category	Type	Usage, Jacket	Color	Length, m	Package	PRICE
L-UO6-DJ	4	6	U/UTP	Outdoor,PE	Black	305	Pull-out box	5,200.00
L-UO6-SJ	4	6	U/UTP	Outdoor,PE	Black	305	Pull-out box	4,800.00
L-UO5-DJ	4	5e	U/UTP	Outdoor,PE	Black	305	Pull-out box	3,800.00
L-UO5-SJ	4	5e	U/UTP	Outdoor,PE	Black	305	Pull-out box	3,500.00

# UTP Cable Product



## LAN Cable Outdoor Drop Wire

### CAT 6



L-UO6-DW-DJ

Cat6 UTP Cable, Outdoor Double Jacket, Drop Wire, 23AWG, 600MHz

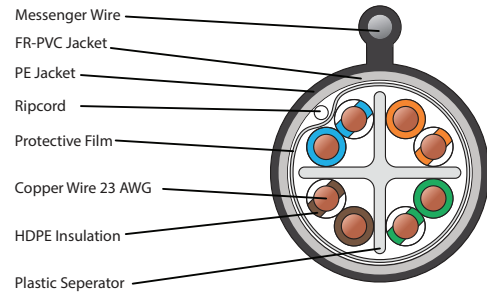

L-UO6-DW2P-DJ

Cat6 UTP Cable, Outdoor Drop Wire with 2Power, Double Jacket, 23AWG, 600MHz

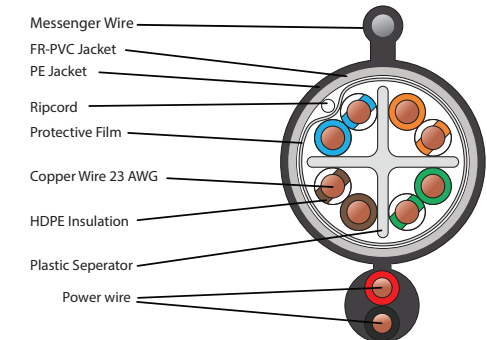

### CAT 5e

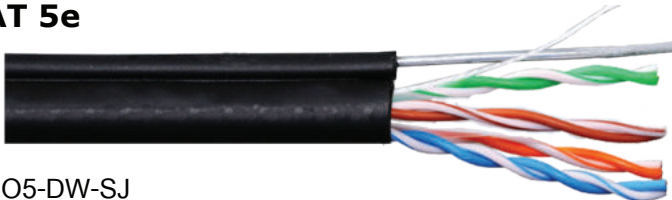

L-UO5-DW-SJ

Cat5e UTP Cable, Outdoor Drop Wire, Single Jacket, 24AWG, 350MHz

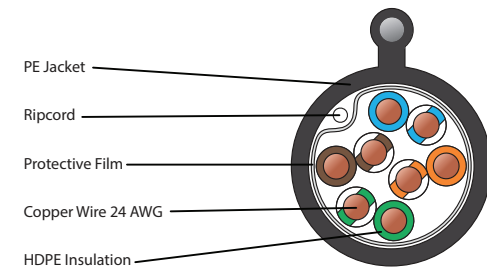

L-UO5-DW-DJ

Cat5e UTP Cable, Outdoor Drop Wire, Double Jacket, 24AWG, 350MHz

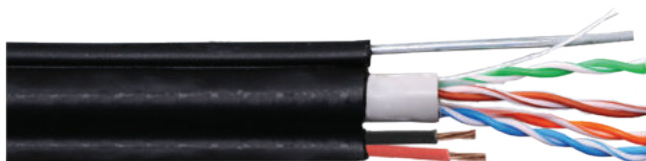
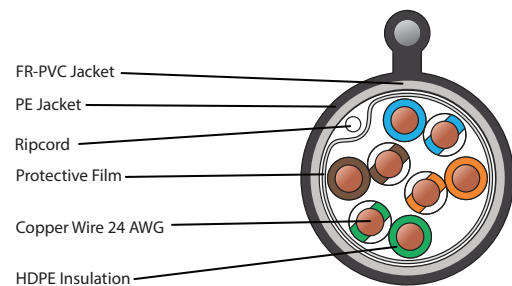

L-UO5-DW2P-DJ

Cat5e UTP Cable, Outdoor Drop Wire with 2Power, Double Jacket, 24AWG, 350MHz

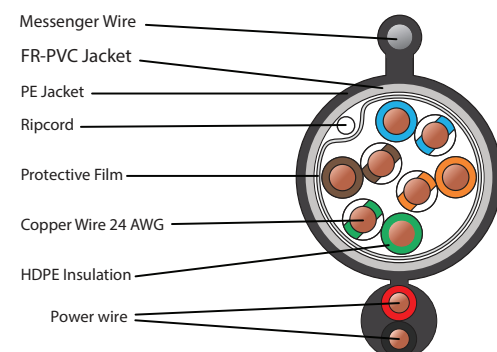

## Specification

Part number	L-UO6-DW-DJ	L-UO6-DW2P-DJ	L-UO5-DW-SJ	L-UO5-DW-DJ	L-UO5-DW2P-DJ
Category	6		5e		
Bandwidth (MHz)	600 MHz		350 MHz		
Type of cable	U/UTP		U/UTP		
Number of pairs	4		4		
Conductor material	Copper		Copper		
Type of conductor	Solid		Solid		
Diameter of conductors	0.57 ± 0.01 mm		0.5mm		
Messenger Wire	1.3 mm.		1.3 mm.		
Power Wire	2*9*0.38 mm CCA		2*9*0.38 mm CCA		
Material of conductor insulation	High Density Polyethylene (HDPE)		High Density Polyethylene (HDPE)		
Diameter of wire insulation	1.09 ± 0.05 mm	1.09 ± 0.05 mm	1 ± 0.05 mm	0.9 ± 0.05 mm	0.90±0.5 mm.
Outer jacket Material	PE		PE		
Inner Jacket material	FR-PVC		-	FR-PVC	
Usage	Outdoor		Outdoor		
Inner Jacket Thickness	6.0 mm	6.0 mm	-	5.1 mm	5.1 mm
Outer diameter of jacket	7.4 ± 0.3 mm	6.5 ± 0.3 mm	5.5 ± 0.3 mm	6.3 ± 0.3 mm	5.5 ± 0.3 mm
Jacket color	Black		Black		
Protective film	Polyester		Polyester		
Ripcord	Yes		Yes		
Min. bending radius during cabling	≥ 4x OD		≥ 4x OD		
Min. bending radius during operation	≥ 8x OD		≥ 8x OD		
Max. tensile strength, N	Max 100 N		Max 100 N		
Characteristic impedance, ohms	100 ± 15 ohms at 20°C		100 ± 15 ohms at 20°C		
Max. conductor resistance(DC)	95 ohms/km				
Compliance	ISO/IEC 11801, EN 50173 and ANSI/TIA-568-C.2, RoHS, REACH				
Application	10BASE-T, 100BASE-TX, 100BASE-T4, 1000BASE-T, 10GBASE-T (55 M)ATM-25, ATM-51, ATM-155, 100VG-AnyLan, TR-4, TR-16 Active, TR-16 Passive				
Temperature range	Storage -60 to +60°C. Installation from 10 to +50°C. Operating from -60 to +60°C				

## Ordering Table

Part Number	Pairs	Category	Type	Usage, Jacket	Color	Length, m	Package	PRICE
L-UO6-DW2P-DJ	4	6	U/UTP	Outdoor,PE	Black	305	Pull-out box	6,500.00
L-UO6-DW-DJ	4	6	U/UTP	Outdoor,PE	Black	305	Pull-out box	5,500.00
L-UO5-DW2P-DJ	4	5e	U/UTP	Outdoor,PE	Black	305	Pull-out box	5,500.00
L-UO5-DW-DJ	4	5e	U/UTP	Outdoor,PE	Black	305	Pull-out box	4,200.00
L-UO5-DW-SJ	4	5e	U/UTP	Outdoor,PE	Black	305	Pull-out box	3,800.00



## Patch Panel

### Patch Panel CAT5E (24 port)



#### 19" 1U UTP Patch Panel CAT5E

- Compatible both T568A and T568B wiring schemes.
- Designed to fit all standard 19" racks and cabinets.
- Contact Gold Plating 50U".
- Only Accept RJ-45 8P8C PLUG.
- According To: ANSI / TIA-568-C.2, ISO / IEC 11801 2nd Edition, IEC 60603-7.

### Patch Panel CAT6 (24 port)



#### 19" 1U UTP Patch Panel CAT6

- Compatible both T568A and T568B wiring schemes.
- Designed to fit all standard 19" racks and cabinets.
- Contact Gold Plating 50U".
- Only Accept RJ-45 8P8C PLUG.
- According To: ANSI / TIA-568-C.2, ISO / IEC 11801 2nd Edition, IEC 60603-7.

## Patch Panel Unload



#### 19" 1U UTP Patch Panel Unload, Blank 24 ports

- Improving accessibility: termination field is closer
  - toinstaller for easier termination
  - Low profile: offering more aisle space in small closets
- Designed to easily route cables into vertical cablemanagers.



#### 19" 1U UTP Patch Panel Unload,1U 24PORT FTP

- 24 PORT in one unit height.
- With gourd wire.
- Available to fit with cat5e, 6, 6A RJ45 keystone Jacks.
- Available to fit with cat5e, 6, 6A RJ45 keystone Jacks.

### Ordering Table

PRODUCT	PART NUMBER	DESCRIPTION	PRICE
Patch Panel	L-PP-U5-24	19" 1U UTP Patch Panel CAT5E, 24 Ports, Toolless, With back bar	1,560.00
	L-PP-U6-24	19" 1U UTP Patch Panel CAT6, 24 Ports, Toolless, With back bar	2,040.00
	L-PP-U-UL-24	19" 1U UTP Patch Panel Unload, Blank 24 ports for Keystone Jack, With back bar	720.00
	L-PP-U-UL-24-FTP	19" 1U UTP Patch Panel Unload,1U 24PORT FTP Blank Patch Panel, With back bar	1,000.00

# Accessories For UTP Cable Product



## Patch Cord CAT5E



### Features

- RJ45 Gold Plated: FU" ~ 50U" Available.
- Cable Conductor: Bare Copper 24AWG.
- Cable Jacket: PVC or LSZH Available.
- UL Certified & ETL Verified.

### Colors



## Patch Cord CAT6



### Features

- RJ45 Gold Plated: FU" ~ 50U" Available.
- Cable Conductor: Bare Copper 23AWG.
- Cable Jacket: PVC or LSZH Available.
- UL Certified, ETL & DELTA Verified.

### Colors



## Patch Cord CAT6A



### Features

- RJ45 Gold Plated: FU" ~ 50U" Available.
- Cable Conductor: Bare Copper 26AWG.
- Cable Jacket: PVC or LSZH Available.
- UL Certified & DELTA Verified.

### Colors



## Patch Cord CAT5E Outdoor



### Features

- RJ45 Gold Plated: FU" ~ 50U" Available.
- Cable Conductor: Bare Copper 24AWG.
- Cable Jacket: PE or LSZH Available.
- UL Certified & ETL Verified.

### Colors



## Patch Cord CAT6 Outdoor



### Features

- RJ45 Gold Plated: FU" ~ 50U" Available.
- Cable Conductor: Bare Copper 23AWG.
- Cable Jacket: PE or LSZH Available.
- UL Certified, ETL & DELTA Verified.

### Colors



## Patch Cord CAT6A (STP)



### Features

- RJ45 Gold Plated: FU" ~ 50U" Available.
- Cable Conductor: Bare Copper 26AWG.
- Cable Jacket: PVC or LSZH Available.
- UL Certified, ETL & DELTA Verified.

### Colors



## Ordering Table

Color Code X = R W Y G B BB

PRODUCT	PART NUMBER	DESCRIPTION	PRICE
Patch Cord CAT5E	L-PC-U5-1-X	Cat5e Patch Cord RJ45 to RJ45 1M	70.00
	L-PC-U5-2-X	Cat5e Patch Cord RJ45 to RJ45 2M	80.00
	L-PC-U5-3-X	Cat5e Patch Cord RJ45 to RJ45 3M	90.00
Patch Cord CAT5E Outdoor	L-PC-UO5-1-X	Cat5e Patch Cord, Outdoor, RJ45 to RJ45 1M	80.00
	L-PC-UO5-2-X	Cat5e Patch Cord, Outdoor, RJ45 to RJ45 2M	90.00
	L-PC-UO5-3-X	Cat5e Patch Cord, Outdoor, RJ45 to RJ45 3M	100.00
Patch Cord CAT6	L-PC-U6-1-X	Cat6 Patch Cord RJ45 to RJ45 1M	90.00
	L-PC-U6-2-X	Cat6 Patch Cord RJ45 to RJ45 2M	100.00
	L-PC-U6-3-X	Cat6 Patch Cord RJ45 to RJ45 3M	110.00
Patch Cord CAT6 Outdoor	L-PC-UO6-1-X	Cat6 Patch Cord, Outdoor, RJ45 to RJ45 1M	110.00
	L-PC-UO6-2-X	Cat6 Patch Cord, Outdoor, RJ45 to RJ45 2M	130.00
	L-PC-UO6-3-X	Cat6 Patch Cord, Outdoor, RJ45 to RJ45 3M	150.00
Patch Cord CAT6A	L-PC-US6A-1-X	Cat6A Patch Cord Slim, RJ45 to RJ45 1M	150.00
	L-PC-US6A-2-X	Cat6A Patch Cord Slim, RJ45 to RJ45 2M	200.00
	L-PC-US6A-3-X	Cat6A Patch Cord Slim, RJ45 to RJ45 3M	250.00
Patch Cord CAT6A (STP)	L-PC-US6A-1-X	Cat6A STP Patch Cord Slim, RJ45 to RJ45 1M	200.00
	L-PC-US6A-2-X	Cat6A STP Patch Cord Slim, RJ45 to RJ45 2M	250.00
	L-PC-US6A-3-X	Cat6A STP Patch Cord Slim, RJ45 to RJ45 3M	300.00

## Additional

- Patch Cord CAT5E + 10.- Per M.
- Patch Cord CAT5E Outdoor + 10.- Per M.
- Patch Cord CAT6 + 10.- Per M.
- Patch Cord CAT6 Outdoor + 10.- Per M.
- Patch Cord CAT6A + 50.- Per M.
- Patch Cord CAT6A (STP) + 50.- Per M.

## Keystone Jack

### RJ45 Keystone Jack



CAT5E Toolless Type,  
90 Degree



UTP CAT6 Toolless Type,  
90 Degree



UTP CAT6A Toolless Type,  
180 Degree



UTP CAT6A FTP, Toolless  
Type, 180 Degree



Connection Box, CAT5E



Connection Box, CAT6

### Multimedia Jack



HDMI Keystone Jack



Jack USB 2.0 A Female to A Female



Coaxial TV



Module BNC Female to Female



Fiber Optic ST Adapter



Fiber Optic SC Adapter



Modular RCA female to female



Banana Jack Black Ring



Banana Jack Red Ring



3.5mm Stereo Female to Female



Blank Insert for Wall Plate



### Ordering Table

Standard : ISO / IEC 11801 and the ANSI/TIA-568-C.2.

PRODUCT	PART NUMBER	DESCRIPTION	PRICE
RJ45 Keystone Jack	L-KJ-U5	CAT5E Keystone Jack Toolless Type, 90 Degree	55.00
	L-KJ-U6	UTP CAT6 Keystone Jack Toolless Type, 90 Degree	68.00
	L-KJ-U6A	UTP CAT6A Keystone Jack Toolless Type, 180 Degree	100.00
	L-KJ-U6A-FTP	UTP CAT6A FTP, Keystone Jack Toolless Type, 180 Degree	150.00
	L-CB-U5	Connection Box, CAT5E	100.00
	L-CB-U6	Connection Box, CAT6	150.00
Multimedia Jack	L-KJ-HDMI	HDMI Keystone Jack	100.00
	L-KJ-USB2.0	USB Keystone Jack USB 2.0 A Female to A Female	68.00
	L-KJ-CATV	Coaxial TV Keystone Jack	55.00
	L-KJ-BNC-FF	Keystone Jack Module BNC Female to Female	60.00
	L-KJ-FO-ST	Fiber Optic ST Adapter Keystone Jack	200.00
	L-KJ-FO-SC	Fiber Optic SC Adapter Keystone Jack	200.00
	L-KJ-RCA-FF	Keystone Jack Modular RCA female to female (Gold Plated )	60.00
	L-KJ-BJ-BR	Keystone Jack Banana Jack Black Ring	55.00
L-KJ-BJ-RR	Keystone Jack Banana Jack Red Ring	55.00	
L-KJ-ST-FF	Keystone Jack 3.5mm Stereo Female to Female	60.00	
L-KJ-BK	Blank Insert for Wall Plate	15.00	

## Modular Plug and Boot

### RJ45 Modular Plug

**CAT5e**



**Features**

- For solid cable

**CAT6**



**Features**

- For solid cable

**CAT6 STP**



**Features**

- For solid cable

**CAT6A STP**



**Features**

- 8P8C Modular Plug, UP:6pin, Down:2pin, Three-piece suit

### EZ RJ45 Modular Plug

**CAT5E/CAT6**



**Features**

- Clear polycarbonate
- Unshielded
- Gold-plated contacts
- Round cable entry

### Tooless Modular Plug

**CAT6**



**Features**

- Clear polycarbonate
- Unshielded
- Gold-plated contacts
- Round cable entry

**CAT6 STP/CAT6A STP**



**Features**

- Clear polycarbonate
- Unshielded
- Gold-plated contacts
- Round cable entry

### RJ45 Boots

#### Plug Strain Relief Boot



**Features**

- Color: Transparent
- Package: 100pcs Per Bag
- Application: For RJ45 Male Connectors

#### Plug Boot Colors



**Colors**



### Ordering Table

Color Code **XX** = R W Y G B

PRODUCT	PART NUMBER	DESCRIPTION	PRICE
RJ45 Modular Plug	L-MP-U5	UTP CAT5E 8P8C Modular Plug	5.00
	L-MP-U6	UTP CAT6 8P8C Modular Plug	9.00
	L-MP-U6-STP	UTP CAT6 8P8C Modular Plug, STP	15.00
	L-MP-U6A-STP	UTP CAT6A STP, 8P8C Modular Plug, UP:6pin, Down:2pin, Three-piece suit	25.00
EZ RJ45 Modular Plug	L-EZMP-U5	EZ UTP CAT5E 8P8C Modular Plug	6.00
	L-EZMP-U6/A	EZ UTP CAT6 8P8C Modular Plug	11.00
Tooless Modular Plug	L-TL-MP-U6	Tooless Modular Plug, CAT6	100.00
	L-TL-MP-U6-STP	Tooless Modular Plug, CAT6, STP	150.00
	L-TL-MP-U6A-STP	Tooless Modular Plug, CAT6A, STP	200.00
RJ45 Boots	L-PB-O	Plug Strain Relief Boot	4.80
	L-PB-XX	Plug Boot Colors	4.00



## Face Plate



### Features

- Color: White / Ivory Available
- 1, 2, 4, Port Available

## Face Plate With Label



### Features

- Color: White / Ivory Available
- 1, 2, 4, Port Available

## Wall Mount Box



### Features

- Simple installation and termination.
- With Twin Adhesive x 1pc, Screw x 2pcs.

## Surface Box



### Features

- Single Surface Box Empty (With out RJ45 Jack)
- Dual Surface Box Empty (With out RJ45 Jack)

## Floor Socket



### Features

- Floor Socket, 1, 2 pcs Universal Socket

## Ordering Table

PRODUCT	PART NUMBER	DESCRIPTION	PRICE
Face Plate & Box	L-FP-01	Face Plate, 1Port Size 70x115mm	18.00
	L-FP-02	Face Plate, 2Port Size 70x115mm	18.00
	L-FP-04	Face Plate, 4Port Size 70x115mm	29.00
Face Plate With Label	L-FPL-01	Face Plate, 1Port with label Size 70x115mm	22.00
	L-FPL-02	Face Plate, 2Port with label Size 70x115mm	25.00
	L-FPL-04	Face Plate, 4Port with label Size 70x115mm	30.00
Box	L-Box-01	Wall Mount Box	24.00
Surface Box	L-SFB-01	Surface Box 1 Port	40.00
	L-SFB-02	Surface Box 2 Port	50.00
Floor Socket	L-FS01-PRJ	Floor Socket, 1pcs Universal Socket and RJ45 Jack	1,000.00
	L-FS02-PRJ	Floor Socket, 2pcs Universal Socket and RJ45 Jack	1,200.00



# RACK AND CABINET

- Wall Rack
- Server and Network Rack
- Open Rack
- Data Center Rack
- Intelligent Data Center Rack
- Data Center Room
- Outdoor Rack
- Fan and Tray
- Power Bar

**Customize Product** บริษัทสามารถผลิตตู้ตามที่คุณต้องการ



## Wall Cabinet

Fixed Model (WCF)



Swing Model (WCS)



Perfeorrante Model (WCP)



### APPLICATION

Widely used in network system, educational system, broadcasting system and telecommunication system. Suitable for placing server computer and precision electronic equipment.

### MATERIALS

Galvanized Cool rolled steel

Thickness: Vertical rail: 2mm

Else in 1.2mm

Tempered smoky-gray glass with thickness of 5mm.

Electro static powder coating.

Including green-yellow ground wire size 2.5mm.

### FEATURE

- Exquisite design with precise dimension and craftsmanship.
- International popular tempered smoky-gray glass front door.
- Easily be mounted on wall, or placed on floor after installed castor or feet.
- Loading capacity: 60KG.
- Top and bottom wiring channel could be closed.
- Removable front door, back door and side panel, easily installing and maintaining
- Surface finish: Degreased, acid cleaned, phosphoric, water cleaned, electro-static powder coating.

### Ordering Table

Color Code **XX** = BG BB

PRODUCT	SIZE	PART NUMBER	DESCRIPTION	PRICE
Fixed Model (WCF)	WCF 6U	R-WCF6-6040-BB/BG	19" Glass Wall Rack Cabinet , 6U Depth 400	2,900.00
		R-WCF6-6050-BB/BG	19" Glass Wall Rack Cabinet , 6U Depth 500	3,300.00
		R-WCF6-6060-BB/BG	19" Glass Wall Rack Cabinet , 6U Depth 600	3,350.00
	WCF 9U	R-WCF9-6040-BB/BG	19" Glass Wall Rack Cabinet , 9U Depth 400	3,250.00
		R-WCF9-6050-BB/BG	19" Glass Wall Rack Cabinet , 9U Depth 500	3,650.00
		R-WCF9-6060-BB/BG	19" Glass Wall Rack Cabinet , 9U Depth 600	3,750.00
	WCF 12U	R-WCF12-6040-BB/BG	19" Glass Wall Rack Cabinet , 12U Depth 400	3,700.00
		R-WCF12-6050-BB/BG	19" Glass Wall Rack Cabinet , 12U Depth 500	4,100.00
		R-WCF12-6060-BB/BG	19" Glass Wall Rack Cabinet , 12U Depth 600	4,300.00
Swimg Model (WCS)	WCS 6U	R-WCS6-6040-BB/BG	19" Glass Wall Rack Cabinet , 6U Depth 400	3,200.00
		R-WCS6-6050-BB/BG	19" Glass Wall Rack Cabinet , 6U Depth 500	3,600.00
		R-WCS6-6060-BB/BG	19" Glass Wall Rack Cabinet , 6U Depth 600	3,800.00
	WCS 9U	R-WCS9-6040-BB/BG	19" Glass Wall Rack Cabinet , 9U Depth 400	3,500.00
		R-WCS9-6050-BB/BG	19" Glass Wall Rack Cabinet , 9U Depth 500	4,000.00
		R-WCS9-6060-BB/BG	19" Glass Wall Rack Cabinet , 9U Depth 600	4,200.00
	WCS 12U	R-WCS12-6040-BB/BG	19" Glass Wall Rack Cabinet , 12U Depth 400	4,000.00
		R-WCS12-6050-BB/BG	19" Glass Wall Rack Cabinet , 12U Depth 500	4,400.00
		R-WCS12-6060-BB/BG	19" Glass Wall Rack Cabinet , 12U Depth 600	4,800.00
Perfeorrante Model (WCP)	WCP 6U	R-WCS6-6040-BB	19" Perfeorrante Stell Wall Rack Cabinet, 6U Depth 400	3,250.00
		R-WCS6-6050-BB	19" Perfeorrante Stell Wall Rack Cabinet, 6U Depth 500	3,800.00
		R-WCS6-6060-BB	19" Perfeorrante Stell Wall Rack Cabinet, 6U Depth 600	4,200.00
	WCP 9U	R-WCS9-6040-BB	19" Perfeorrante Stell Wall Rack Cabinet, 9U Depth 400	4,000.00
		R-WCS9-6050-BB	19" Perfeorrante Stell Wall Rack Cabinet, 9U Depth 500	4,200.00
		R-WCS9-6060-BB	19" Perfeorrante Stell Wall Rack Cabinet, 9U Depth 600	4,500.00
	WCP 12U	R-WCS12-6040-BB	19" Perfeorrante Stell Wall Rack Cabinet, 12U Depth 400	4,800.00
		R-WCS12-6050-BB	19" Perfeorrante Stell Wall Rack Cabinet, 12U Depth 500	5,000.00
		R-WCS12-6060-BB	19" Perfeorrante Stell Wall Rack Cabinet, 12U Depth 600	5,500.00

## Open Rack

**Open Rack 42 U Type A**



**Open Rack 42 U Type B**



### Application

Widely used in network system, educational system, broadcasting system and telecommunication system. Suitable for placing server computer and precision electronic equipment.

### Materials

Galvanized Cool rolled steel

Thickness: Front and bottom beams: 1.5mm

Else in 1.2mm

### Feature

- Modular design, easily assemble and disassembly for delivery, low cost.
- Various optional accessories according to requirements.
- Static load: 150kg
- Level of protection: IP20
- Surface finish: Degreased, acid cleaned, phosphoric, water cleaned, electro-static powder coating.

### Standard

Comply with ANSI/EIARS-310-D, DIN41491; PART1, IEC297-2, DIN41494; PART7, GB/T3047.2-92 standard. Compatible with metric ETSI and 19 inch international standard.

### Ordering Table

PRODUCT	SIZE	PART NUMBER	DESCRIPTION	PRICE
Open rack	42 U	R-OPA42	Open Rack Type A 42 U	6,500.00
		R-OPB42	Open Rack Type B 42 U	4,500.00



## Server and Network Rack



### Application

Widely used in network system, educational system, broadcasting system and telecommunication system. Suitable for placing server computer and precision electronic equipment.



Crescent lock



easily assembled side panel



Symmetrical frame



double swing steel door



Cooling fan



Bottom plate

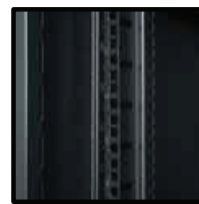

Mounting rail with U mark



smoky-gray glass door

### Materials

Galvanized Cold-rolled steel sheet. Thickness for frame (Nine-fold section steel)

1.5mm, mounting rail 2.0mm, side panel 1.5mm.

Electro static powder coating.

Including green-yellow ground wire size 2.5mm.

### Feature

- Exquisite design with precise craftsmanship
- Good compatibility, adapt to more servers. Perfect ventilation
- Vented front door and rear door enable ventilation and reliable operation
- The top and bottom wiring channel can be closed and adjusted.
- Optional plinth to meet under base wiring, ventilation and rat-proof
- Rack's side panel can be easily assembled.
- Adjustable feet and heavy duty castors are available at the same time , static loading: 800kg.(with adjustable feet).
- Surface finish: degreasing, pickling, phosphating, power coating.
- Height, width, and depth selectable, full range of optional accessories.
- Adjustable feet and heavy duty castors are available at the same time, static loading: 800KG

### Ordering Table

PRODUCT	SIZE	PART NUMBER	DESCRIPTION	PRICE
Server/Network Cabinet	15U	R-N15-6060-NFA	19" Network Rack Cabinet, 15U Glass Door, Double Swing Steel Door, 600x600	10,260.00
	27U	R-N27-6060-NFA	19" Network Rack Cabinet, 27U Glass Door, Double Swing Steel Door 600x600	12,540.00
		R-N27-6080-NFA	19" Network Rack Cabinet, 27U Glass Door, Double Swing Steel Door 600x800	13,680.00
		R-N27-6010-NFA	19" Network Rack Cabinet, 27U Glass Door, Double Swing Steel Door 600x1000	14,820.00
	36U	R-N36-6060-NFA	19" Network Rack Cabinet, 36U Glass Door, Double Swing Steel Door 600x600	13,110.00
		R-N36-6080-NFA	19" Network Rack Cabinet, 36U Glass Door, Double Swing Steel Door 600x800	14,820.00
		R-N36-6011-NFA	19" Network Rack Cabinet, 36U Glass Door, Double Swing Steel Door 600x1100	17,100.00
		R-N36-8080-NFA	19" Network Rack Cabinet, 36U Glass Door, Double Swing Steel Door 800x800	21,660.00
		R-N36-8011-NFA	19" Network Rack Cabinet, 36U Glass Door, Double Swing Steel Door 800x1100	22,800.00
	42U	R-N42-6060-NFA	19" Network Rack Cabinet, 42U Glass Door, Double Swing Steel Door 600x600	15,390.00
		R-N42-6080-NFA	19" Network Rack Cabinet, 42U Glass Door, Double Swing Steel Door 600x800	17,100.00
		R-N42-6011-NFA	19" Network Rack Cabinet, 42U Glass Door, Double Swing Steel Door 600x1100	18,810.00
		R-N42-8080-NFA	19" Network Rack Cabinet, 42U Glass Door, Double Swing Steel Door 800x800	22,230.00
		R-N42-8011-NFA	19" Network Rack Cabinet, 42U Glass Door, Double Swing Steel Door 800x1100	23,940.00

# Rack and Cabinet Product

## Data Center Cabinet



### Application

Widely used in network system, educational system, broadcasting system and telecommunication system. Suitable for placing server computer and precision electronic equipment.

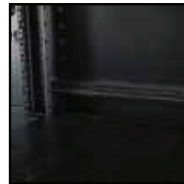

Frame with scale mark



Mounting rail with U mark



Connection Kits



Removable double-section side panel

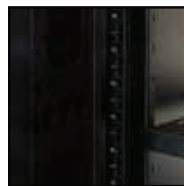

Backside with a pair of vertical cable management

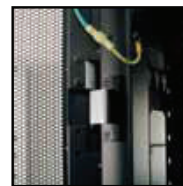

Enhanced hinge



Curved perforated door



Steel casement door

### Materials

Galvanized Cold-rolled steel sheet. Thickness for frame 2.0mm, mounting rail 2.0mm, side panel 1.5mm, fixed shelf 1.5mm

### Feature

- Surface finish: degreasing, pickling, phosphoric, powder coating . The thickness of powder coating is 80µm-100µm.
- Curved perforated front door and double-section rear door enable equipment protection, reliable operation with ventilation rate above 80%.
- Double-section side panels, each panel can be easily assembled separately.
- Top and bottom wiring channel can be closed and adjustable.
- Backside with a pair of vertical cable management.
- Mounting rail with U mark.
- static loading: 1000KG

### Standard

Comply with ANSI/EIARS-310-D, DIN41491; PART1, IEC297-2,DIN41494; PART7, GB/T3047.2-92 standard. Compatible with metric ETSI and 19 inch international standard, ROHS standard.

### Ordering Table

PRODUCT	SIZE	PART NUMBER	DESCRIPTION	PRICE
Data Center Cabinet	36U	R-D36-6060-KLA	19" Data Center Cabinet, 36U Curved Perforated Door, Double Swing Door 600x600	22,800.00
		R-D36-6080-KLA	19" Data Center Cabinet, 36U Curved Perforated Door, Double Swing Door 600x800	25,080.00
1000 Kg		R-D36-6011-KLA	19" Data Center Cabinet, 36U Curved Perforated Door, Double Swing Door 600x1100	26,220.00
		R-D36-8080-KLA	19" Data Center Cabinet, 36U Curved Perforated Door, Double Swing Door 800x800	28,500.00
		R-D36-8011-KLA	19" Data Center Cabinet, 36U Curved Perforated Door, Double Swing Door 800x1100	29,640.00
	42U	R-D42-6060-KLA	19" Data Center Cabinet, 42U Curved Perforated Door, Double Swing Door 600x600	23,370.00
		R-D42-6080-KLA	19" Data Center Cabinet, 42U Curved Perforated Door, Double Swing Door 600x800	25,080.00
		R-D42-6011-KLA	19" Data Center Cabinet, 42U Curved Perforated Door, Double Swing Door 600x1100	27,360.00
		R-D42-8080-KLA	19" Data Center Cabinet, 42U Curved Perforated Door, Double Swing Door 800x800	29,640.00
		R-D42-8011-KLA	19" Data Center Cabinet, 42U Curved Perforated Door, Double Swing Door 800x1100	31,920.00
4 Door	42U	R-D42-4D-8011-KLA	19" Data Center Cabinet, 42U, 4 Door, Double Swing Door 800x1100	45,000.00

# Rack and Cabinet Product

## Intelligent Data Center Rack



### Description

Intelligent Data cabinets are 19" standard rack-mountable enclosures. It is commonly used, and can be installed by all kinds of standard servers, networking equipments, industrial controlling equipments ,etc. The power, temperature and humidity of the cabinets have environmental intelligent monitoring function, and built-in electronic entrance guard system. The successful application of AC series cabinet, reduced the maintenance personnel's tour and maintenance burden, and improve the reliability of system; More important is blending the advanced management, make the access point reached a new cabinet type of management level.

### Specifications

- Material: high quality SPCC
- Pillar: high strength profiles column;
- Base: assembly type bearing bas, bottom presets adjustable wind path;
- Top: assembly type; threading hole are presented from front to back;
- The front door: steel mesh front door or toughened glass door, electronic lock;
- Rear door : steel mesh arch-off door, electronic lock;

### Feature

- 1 temperature and humidity monitoring: real-time monitoring and display enclosure temperature and humidity
- Intelligent temperature: when the temperature higher than normal, the cabinet fan will automatic startup when undertake discharging hot.
- Power monitoring: monitoring of power supply of the cabinet and display real-time current and voltage values.
- Electronic access: administrators who have possessing operation rights may use IC card o enter the correct password to open the door.
- Remote centralized control: the data of environment and power system installed in different locations of the several of hundreds of racks can be displayed on a remote computer by network.
- Other features: users can also specially order the cabinets with smoke detection, intelligent lighting and short message of intelligent alarm function according to actual needs.
- Multifunction LCD Readout
- static loading: 1000KG

### Ordering Table

PRODUCT	PART NUMBER	DESCRIPTION	PRICE
Intelligent Server cabinet	R-ID42-6012-KLA	19" intelligent server cabinet, 42U Curved Perforated Door, Double Swing Door 600x1200	40,000.00
	R-ID42-8012-KLA	19" intelligent server cabinet, 42U Curved Perforated Door, Double Swing Door 800x1200	45,000.00

## Data Center Room

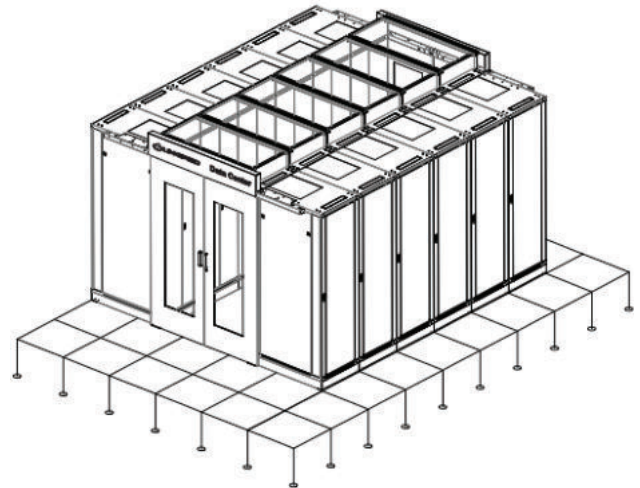
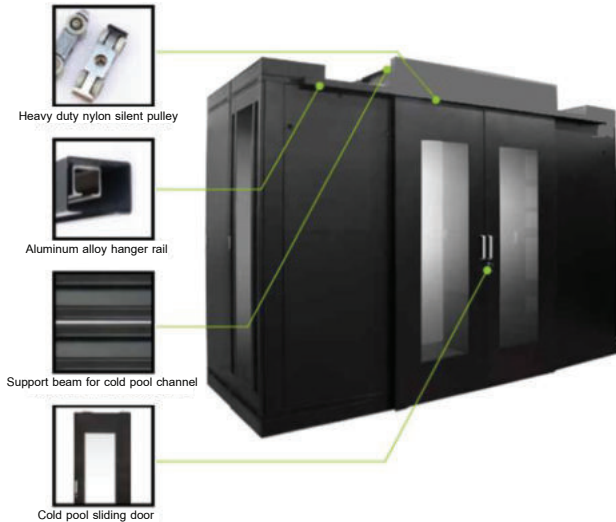

### Material

Galvanized Cold - rolled steel sheet. Thickness for hanger rail 2.0 mm, support beam 1.5mm, sliding door 1.2 mm. Heavy duty nylon silent pulley.

### Application

Mainly applied in Finance, Securities and Data Centre, etc.

### Feature

- Surface finish: degreasing, pickling, phosphoric, powder coating. The thickness of powder coating is 80µm-100µm, complying with ROHS.
- By adopting heavy duty nylon silent pulley and aluminum alloy hanger rail, the sliding door can be opened and closed easily. And the locks on the door are convenient for people managing the cold pool channel.
- The material of sliding door is double-deck cold-rolled sheet metal which make sure a good intensity of the door; And the middle of the door is made up of clear tempering glass which allow the outside people checking the situation of inside channel.
- The support beam on the top of cold pool channel is used for placing tempering glass. The thickness of the support beam is 1.5mm.

### Standard

Comply with ANSI/EIARS-310-D, DIN41491; PART1, IEC297-2, DIN41494; PART7, GB/T3047.2-92 standard. Compatible with metric ETSI and 19 inch international standard.

### SCHEMATIC DIAGRAM OF COLD POOL

→ Hot air      → Cold air

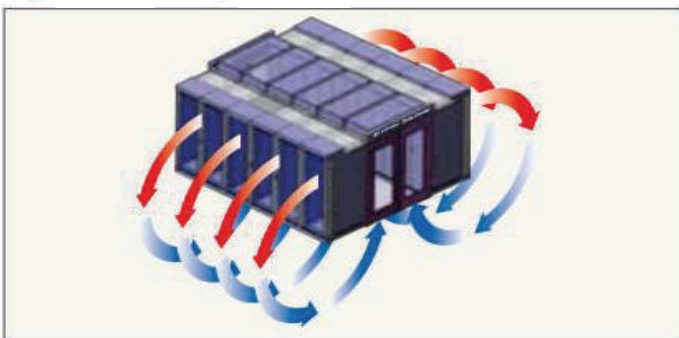

### SECTION VIEW OF COLD POOL

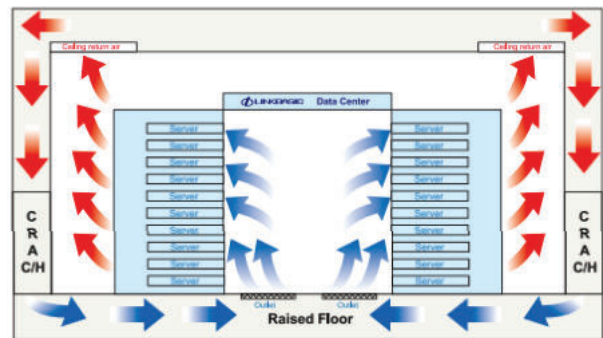

### Ordering Table

PRODUCT	SIZE	PART NUMBER	DESCRIPTION	PRICE
Data Center Room		R-MB-612	Standard 600x1200 cold pool glass roof and mounting bracket	22,000.00
		R-MB-812	Standard 800x1200 cold pool glass roof and mounting bracket	25,000.00
	42 U	R-SD-42	Standard 42U600 wide sliding door cold pool	40,000.00
	47 U	R-SD-47	Standard 47U600 wide sliding door cold pool	50,000.00



## Outdoor Cabinet CCTV

Outdoor Cabinet Steel Type A

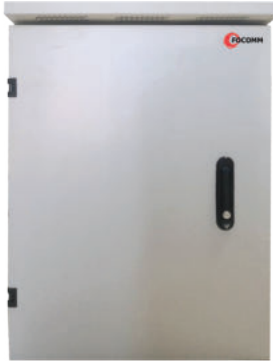

### SPECIFICATION TYPE A

**Panel**

Material : Electro Galvanize Steel  
Thickness : 1.2 mm

**Bracket**

Material : Electro Galvanize Steel  
Material : Aluminium  
Thickness : 2.0 mm

**DIMENTION**

H x W x D : 68.0 x 43.0 x 17.0 cm

Outdoor Cabinet Steel Type B



### SPECIFICATION TYPE B

**Panel**

Material : Electro Galvanize Steel  
Thickness : 1.5 mm

**Bracket**

Material : Electro Galvanize Steel  
Material : Aluminium  
Thickness : 2.0 mm

**DIMENTION**

H x W x D : 74.0 x 50.0 x 25.0 cm

Outdoor Cabinet Steel Type D



### SPECIFICATION TYPE D

**Panel**

Material : Electro Galvanize Steel  
Thickness : 1.2 mm

**Bracket**

Material : Electro Galvanize Steel  
Material : Aluminium  
Thickness : 2.0 mm

**DIMENTION**

H x W x D : 40.0 x 40.0 x 23.0 cm

## Outdoor Rack Stand



### Feature

Outdoor series rack cabinets can be used to meet your requirements with plinth base, standing type wall and pole types. It provides protection of installed applications for ambient and humidity conditions hence galvanized construction and single/double hulls.

Outdoor type rack cabinets provide you IP55 and IP66 class protection for outdoor telecommunication distribution points, CCTV monitoring system, security system, auto ways observing stations, Traffic controlling and observing systems, industrial plants, Military areas, signalizations and communications systems requirements.

### Ordering Table

PRODUCT	SIZE	PART NUMBER	DESCRIPTION	PRICE
Outdoor Cabinet CCTV		R-OD-A	Outdoor Cabinet Steel Type A (68x43x17cm)	3,990.00
		R-ODA-A	Outdoor Cabinet Aluminium Type A (68x43x17cm)	Call
		R-OD-B	Outdoor Cabinet Steel Type B (74.0 x 50.0 x 25.0 cm)	5,244.00
		R-ODA-B	Outdoor Cabinet Aluminium Type B (74.0 x 50.0 x 25.0 cm)	Call
		R-OD-D	Outdoor Cabinet Steel Type D (40x40x23cm)	3,500.00
		R-ODA-D	Outdoor Cabinet Aluminium Type D (40x40x23cm)	Call
Outdoor Rack Stand	15 U	R-OS15-6050-G	19" Rack Outdoor 15U, 60x50cm	Call
		R-OS15-6060-G	19" Rack Outdoor 15U, 60x60cm	Call
	27 U	R-OS27-6050-G	19" Rack Outdoor 27U, 60x50cm	Call
		R-OS27-6060-G	19" Rack Outdoor 27U, 60x60cm	Call

## Heavy Wall Rack Outdoor



### Feature

- 19" Wall Rack type for outdoor, suitable for Network Equipment 19" standard or FDU, Patch Panel and suitable for CCTV system.
- The cabinet compliant with IP55 (Dust and Water protection)
- Designed of two layer, The front and side panel have a sun shield layer for outdoor Harsh Environment installation.
- Structure Produced from Electro-Galvanized Sheet steel with thickness of 1.2mm., Light weight and completed rust proof.
- Front door Designed of two layers, provide build in Push Handle Lock. Ventilation by roofer at front door. Open through 180 degrees.
- Side Panel (Two doors) Designed of two layers with two security lock for safety. Water proof, dust filter and ventilation by roofer at side panel. Open through 120 degrees.
- Back Side Supporting by four steel support bar with thickness of 2.0mm.
- Color The Special dark gray for outdoor color by electrostatic powder coating paint., Scratch resistance and rust protection.

### Ordering Table

PRODUCT	SIZE	PART NUMBER	DESCRIPTION	PRICE
Heavy Wall Rack Outdoor	6U	R-HVOD6U-0640	19" Heavy Wall Rack Outdoor 6U, 60x40 cm	6,500.00
		R-HVOD6U-0650	19" Heavy Wall Rack Outdoor 6U, 60x50 cm	7,200.00
		R-HVOD6U-0660	19" Heavy Wall Rack Outdoor 6U, 60x60 cm	8,200.00
	9U	R-HVOD9U-0640	19" Heavy Wall Rack Outdoor 9U, 60x40 cm	7,000.00
		R-HVOD9U-0650	19" Heavy Wall Rack Outdoor 9U, 60x50 cm	7,200.00
		R-HVOD9U-0660	19" Heavy Wall Rack Outdoor 9U, 60x60 cm	8,600.00
	12U	R-HVOD12U-0640	19" Heavy Wall Rack Outdoor 12U, 60x40 cm	7,200.00
		R-HVO12U-0650	19" Heavy Wall Rack Outdoor 12U, 60x50 cm	7,800.00
		R-HVOD12U-0660	19" Heavy Wall Rack Outdoor 12U, 60x60 cm	9,200.00

## Fan For Wall rack



Fan 1x4"



Fan 2x4"

### Feature

- Specification: 220AC, 50/60HZ, medium speed
- Fame made by aluminum
- Air delivery: 195M3/H
- Noise: <48dB

## Fan For Server Network / Data Center



### Feature

- Specification: 220AC, 50/60HZ, medium speed
- Fame made by aluminum
- Air delivery: 195M3/H
- Noise: <48dB

## Fix Shelf For Wall Rack / For Server Network / Data Center



### Feature

- Materials: Cool Rolled Steel.
- Color: Black / gray
- Features: Adjustable Mounting Distance, Uniform Distribution Thermal via.
- Surface finish: Degreasing, phosphoric, water cleaning, electro-static powder coating.

## Slide Shelf



### Feature

- Materials: cool rolled steel.
- Color: black
- Features: adjustable mounting distance, uniform distribution thermal via.
- Surface finish: Degreasing, phosphoric, water cleaning, electro-static powder coating.

## Ordering Table

Color Code  = B  = G

PRODUCT	PART NUMBER	DESCRIPTION	PRICE
Fan for wall	R-FAN-W1	Fan 1x4" for Wall Rack	350.00
	R-FAN-W2	Fan 2x4" for Wall Rack	1,100.00
Fan for Server Network	R-FAN-2	Fan 2x4"	1,700.00
	R-FAN-4	Fan 4x4"	2,000.00
Fan for Data Center	R-DFAN-4	Fan 4x4" for Data Center	2,400.00
	R-DFAN-6	Fan 6x4" for Data Center	3,000.00
Fix Shelf For Wall Rack	R-FS-40-B/G	Fix Shelf, 1.2mm Depth 400 For Wall Rack	570.00
	R-FS-50-B/G	Fix Shelf, 1.2mm Depth 500 For Wall Rack	600.00
Fix Shelf For Server Network	R-FS-60-B	Fix Shelf, 1.2mm Depth 600	640.00
	R-FS-80-B	Fix Shelf, 1.2mm Depth 800	684.00
	R-FS-100-B	Fix Shelf, 1.2mm Depth 1000	798.00
Fix Shelf For Data Center	R-DFS-60-B	Fix Shelf, 1.5mm Depth 600 for Data Center	900.00
	R-DFS-80-B	Fix Shelf, 1.5mm Depth 800 for Data Center	1,000.00
	R-DFS-100-B	Fix Shelf, 1.5mm Depth 1000 for Data Center	1,200.00
Slide Shelf	R-SS-60-B	Slide Shelf Depth 600	1,200.00
	R-SS-80-B	Slide Shelf Depth 800	1,700.00
	R-SS-100-B	Slide Shelf Depth 1000	2,000.00

## horizontal cable management



Horizontal Cable Management Panel With Cover



Horizontal Cable Management Ring Panel

### Feature

- Materials: 1.2mm cold rolled steel & ABS engineering plastics
- Color: black
- Frame: Independently designed product. The mounting plate can be opened on both sides.
- The perfect combination of metal and plastic.
- Features: Providing flexible, safe and effective management on various cables.
- Horizontal cable management

## Vertical Cable Management



### Feature

- Materials: 1.2mm cold rolled steel & ABS engineering plastics
- Color: black
- Frame: Independently designed product. The mounting plate can be opened on both sides.
- The perfect combination of metal and plastic.
- Features: Providing flexible, safe and effective management on various cables.
- Vertical cable management

## Din Rail Termostat



### Feature

- Large setting range
- Small size
- Simple to mount
- High switching performance

## Plastic Din Stopper



### Feature

- Plastic Din rail stopper EW35
- W35X7.5 grey color

## Nut M6



## Ordering Table

PRODUCT	PART NUMBER	DESCRIPTION	PRICE
Horizontal Cable Management	R-CMH-C	Horizontal Cable Management Panel With Cover	285.00
	R-CMH-R	Horizontal Cable Management Ring Panel	342.00
Vertical Cable Management	R-CMV32	Vertical Cable Management 32U	1,368.00
	R-CMV42	Vertical Cable Management 42U	1,596.00
	R-CMV47	Vertical Cable Management 47U	1,710.00
Termostat	R-KTS-011	Din Rail Termostat 250VAC, 10A	250.00
Plastic Din Stopper	R-EW35	Plastic Din Stopper	15.00
Nut M6	R-NUT-M6	Screw+Nut M6, Plastic Washer	6.00



## Power Bar

Power Bar Universal, Lighting SW and Protection



### Feature

- Nominal Voltage 200 - 250 VAC
- Frequency 50 / 60Hz
- Maximum Amps 16A, 32A
- Plug Type NEMA 5-15P, IEC309 16A & 32A
- Outlet Type Universal, IEC320 C13
- Socket Material Engineering Plastic
- Panel Material Aluminum Alloy
- Outlet quantity 6, 12, 20 outlet
- PDU Bracket Kit Included 1 Pairs
- Compliant RoHS

Power Bar Universal, Circuit Breaker 16A, 32A



### Feature

- Nominal Voltage 200 - 250 VAC
- Frequency 50 / 60Hz
- Maximum Amps 16A, 32A
- Plug Type NEMA 5-15P, IEC309 16A & 32A
- Outlet Type Universal, IEC320 C13
- Socket Material Engineering Plastic
- Panel Material Aluminum Alloy
- Outlet quantity 6, 12, 20 outlet
- PDU Bracket Kit Included 1 Pairs
- Compliant RoHS

Power Bar Universal, Interegent PDU



### Feature

- Input plug : Gb1002 10A 250VAC
- Frequency 50 / 60Hz
- Maximum Amps 10A, 16A
- Cover material : Aluminum alloy
- Outlet Type Universal, IEC320 C13
- Socket Material Engineering Plastic
- Outlet quantity 6, 12 outlet
- Compliant RoHS

Digital Temperature unit



### Feature

- Power supply: 85-265VAC
- Sensor: International cu50 resistance
- Measuring range: -20—80
- Measurement accuracy: 1.0(+/-1.0%)
- Sampling rate: 2/second
- Output form: double relays(one group for master control, another one for alarm)
- Sensor's differential gap adjustable.
- Sensor support open circuit alarm
- Power consumption: <5W
- Ambient temperature: -10 - 50

## Ordering Table

PRODUCT	PART NUMBER	DESCRIPTION	PRICE
Power Bar Lighting SW and Protection	R-PWB-LP-06	6 Power Bar Universal, Lighting SW and Protection, Cable 2m	1,100.00
	R-PWB-LP-12	12 Power Bar Universal, Lighting SW and Protection, Cable 2m	2,000.00
Power Bar Circuit Breaker	R-PWB-CB-06	6 Power Bar Universal, Circuit Breaker 16A, Cable 3m	1,700.00
	R-PWB-CB-12	12 Power Bar Universal, Circuit Breaker 16A, Cable 3m	2,500.00
	R-PWB-CB-20	20 Power Bar Universal, Circuit Breaker 16A, Cable 3m	3,000.00
	R-PWB-CB-24	24 Power Bar Universal, Circuit Breaker 32A, Cable 3m	3,400.00
	R-PWB-CB-IP-06	6 Power Bar Universal, Circuit Breaker 16A, Industril Plug, Cable 2m	2,000.00
	R-PWB-CB-IP-12	12 Power Bar Universal, Circuit Breaker 16A, Industril Plug, Cable 3m	2,800.00
Power Bar Interegent PDU	R-PWR-IT-06	06 Power Bar Universal, Interegent PDU, 10A, 3m	2,400.00
	R-PWR-IT-12	12 Power Bar Universal, Interegent PDU, 16A, 3m	4,500.00
Digital Temperature unit	R-DT	Digital Temperature unit	4,000.00

## Mini Enclosure



### Other Options

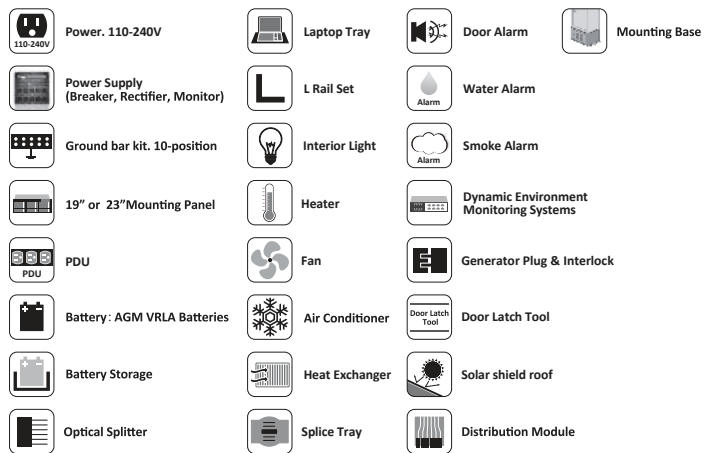

### Feature

- Light weight for easier transportation
- Three installation ways
- lowest priced outdoor rack mount enclosure

## The Multiple Protection

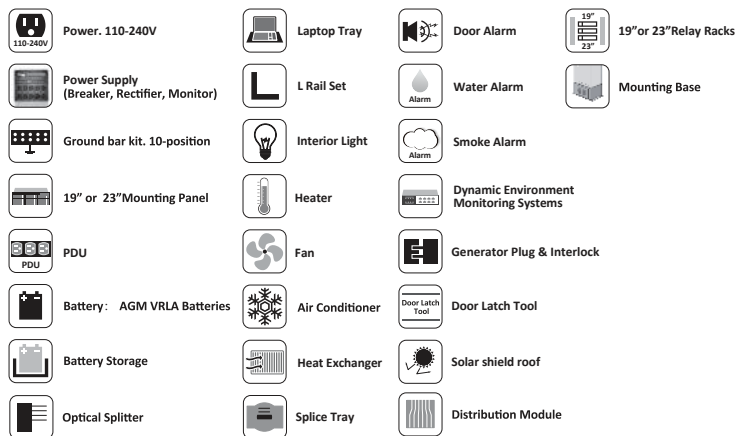

### Feature

- Three-door design for maximum function varieties
- Side compartment for fiber, MDF/VDF modules or embedded climate control equipment
- Fans can be added on the top cover for extra ventilation

### Ordering Table

PRODUCT	PART NUMBER	DESCRIPTION	PRICE
Special Outdoor Rack	R-OD-S1	Mini Enclosure	Call
	R-OD-S2	The Multiple Protection	Call

## Integrated Outdoor Cabinet



### Other Options

- |  |                 |  |  |
|--|-----------------|--|--|
| Power. 110-240V  | Laptop Tray     | Door Alarm                             | " 23" Relay Racks icon"/> 19" or 23" Relay Racks |
| Power Supply (Breaker, Rectifier, Monitor)             | L Rail Set      | Water Alarm                            | Mounting Base                                    |
| Ground bar kit. 10-position                            | Interior Light  | Smoke Alarm                            |  |
| " 23" Mounting Panel icon"/> 19" or 23" Mounting Panel | Heater          | Dynamic Environment Monitoring Systems |  |
| PDU  | Fan             | Generator Plug & Interlock             |  |
| Battery: AGM VRLA Batteries                            | Air Conditioner | Door Latch Tool                        |  |
| Battery Storage  | Heat Exchanger  | Solar shield roof                      |  |
| Optical Splitter                                       | Splice Tray     | Distribution Module                    |  |

### Feature

- Rotatable installation racks for easy management
- A/C Cooling and heating / heat exchange options available
- Heavy duty for extreme heavy equipment



## Multi-functional Tri-Bay Cabinet



### Other Options

- |  |                 |  |  |
|--|-----------------|--|--|
| Power. 110-240V  | Laptop Tray     | Door Alarm                             | " 23" Relay Racks icon"/> 19" or 23" Relay Racks |
| Power Supply (Breaker, Rectifier, Monitor)             | L Rail Set      | Water Alarm                            | Mounting Base                                    |
| Ground bar kit. 10-position                            | Interior Light  | Smoke Alarm                            |  |
| " 23" Mounting Panel icon"/> 19" or 23" Mounting Panel | Heater          | Dynamic Environment Monitoring Systems |  |
| PDU  | Fan             | Generator Plug & Interlock             |  |
| Battery: AGM VRLA Batteries                            | Air Conditioner | Door Latch Tool                        |  |
| Battery Storage  | Heat Exchanger  | Solar shield roof                      |  |
| Optical Splitter                                       | Splice Tray     | Distribution Module                    |  |

### Feature

- Three lockable compartments
- Separated cabins for power, passive and other equipment
- Isolated cabin option for batteries
- Ideal solution for multi-party management

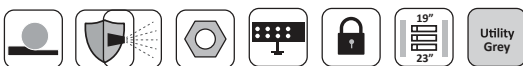

### Ordering Table

PRODUCT	PART NUMBER	DESCRIPTION	PRICE
Special Outdoor Rack	R-OD-S3	Integrated Outdoor Cabinet	Call
	R-OD-S4	Multi-functional Tri-Bay Cabinet	Call

## Micro Data Center

- Micro Data Center
- Power Supply
- Thermal Control
- Rack Supporting
- Monitoring & Management

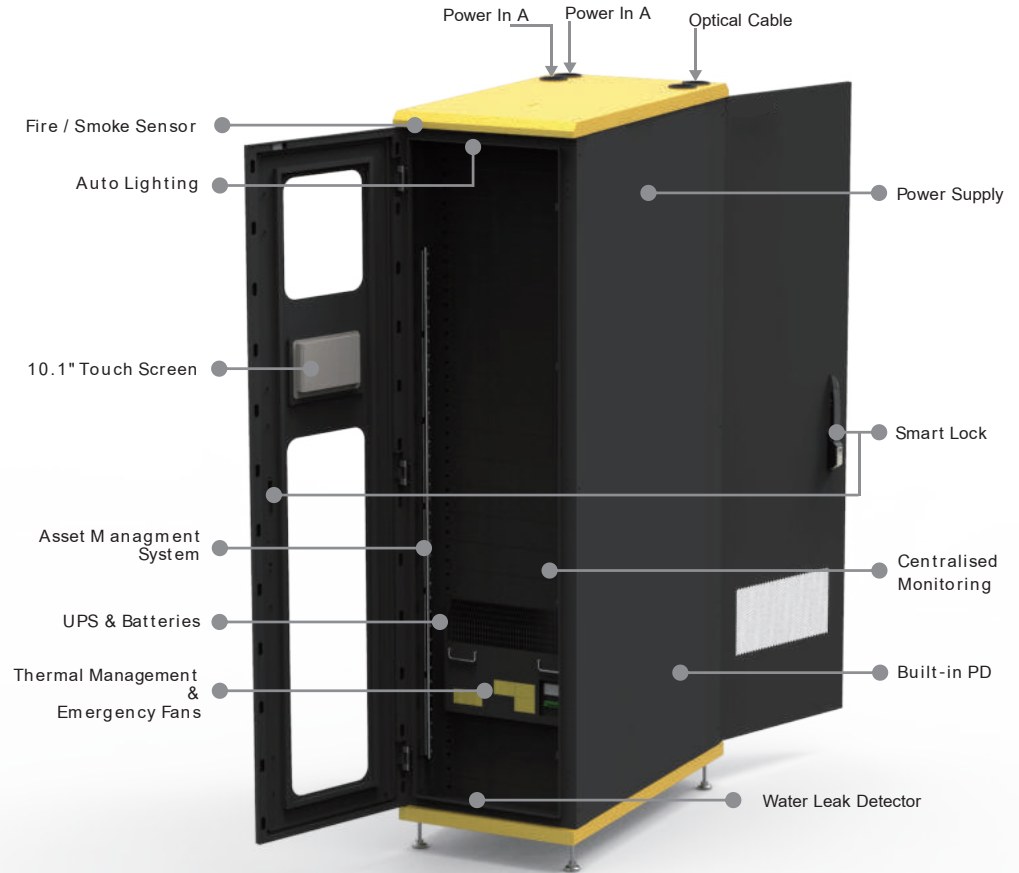

Parameter	Cabinet Center	Parameter	Cabinet Center
Dimensions (H*W*D):	2200mm*600mm*1100mm	System Input Requirement:	Single Phase 110V / 220 V-240 V
Usable Rack Space:	27U	Power Distribution Units (PDU):	16A input, IEC
Air Conditioner:	Integrated	Lightning Protection / Surge Suppression:	Level 3, 20KA
Floor Area (incl. service space):	1.38m	Cooling Capacity:	3.5kW
Color:	Black (RAL 9005)	Emergency Fan:	Optional
Display:	10.1" Touch Screen	System Management (UPS/Cooling/PDU):	Yes
Display Languages:	English / Chinese	Temperature Sensor:	6
Auto LED Lighting:	2, Front & Rear	Water Leak Detector:	1
UPS Capacity:	6kVA	Door Access Sensor:	2
UPS Backup Time:	20-60 minutes @ 3.5kW	Net Weight:	330KG
System Capacity:	3.5kW	Warranty:	2 years

### Ordering Table

PRODUCT	PART NUMBER	DESCRIPTION	PRICE
Micro Data Center	R-MICRO-D42-6011-BB	Micro Data Center 42 U	Call
	R-MICRO-AD42-6011-BB	Micro Data Center 42 U 1xAsset Management System without Battery and UPS	Call



## The Cross Connection Cabinet (FDC) up to 144-576 Core



### Construction

This affordable, high quality Fiber Distribution Cabinet features a low profile design, providing an attractive enclosure for rural & residential deployments. Services up to 576 fiber from a single cabinet.

The Cross Connection Cabinet (FDC) provides a secure transition point from the passive optical network (PON) to the subscriber drop for both pre-configured pigtail and/or patch and splice applications.

### Feature

- Capacity up to 576 fiber
- Customized size available upon request
- Pole and pad versions available
- Front and back access with locking feature
- Provides flexible fiber cable management
- Compatible with all types of PLC splitters
- Pre-connectorized fiber pigtails installed for rapid deployment



## SMC Series polycarbonate outdoor cabinet up to 144-576 Core



### Construction

SMC Series polycarbonate outdoor cabinet is a perfect solution for outdoor fiber connection and distribution applications. Special glass fiber reinforced polycarbonate structure makes this cabinet an ideal solution for cross connect applications.

High strength glass-fiber polyester (SMC) body ensures excellent performance of mechanical durability, anti-erosion, aging resistance and lightweight. The structure is the perfect combination of low weight and high mechanical strength and its functional design gives extra advantages both for installation and cable management.

### Feature

- High strength glass-fiber polyester (SMC) body
- Pole and pad versions available
- Front access with locking feature
- Provides flexible fiber cable management
- Compatible with all types of PLC splitters
- Unique design minimizes fiber routing congestion
- Pre-connectorized fiber pigtails installed for rapid deployment



### Ordering Table

PRODUCT	PART NUMBER	DESCRIPTION	PRICE
The Cross Connection Cabinet (FDC)	R-OD-CCC-144	The Cross Connection Cabinet (FDC) up to 144 core	Call
	R-OD-CCC-288	The Cross Connection Cabinet (FDC) up to 288 core	Call
	R-OD-CCC-432	The Cross Connection Cabinet (FDC) up to 432 core	Call
	R-OD-CCC-576	The Cross Connection Cabinet (FDC) up to 576 core	Call
SMC Series polycarbonate outdoor cabinet	R-OD-SMCP-144	SMC Series polycarbonate outdoor cabinet up to 144 Core	Call
	R-OD-SMCP-288	SMC Series polycarbonate outdoor cabinet up to 288 Core	Call
	R-OD-SMCP-576	SMC Series polycarbonate outdoor cabinet up to 576 Core	Call

## Distribution Modules

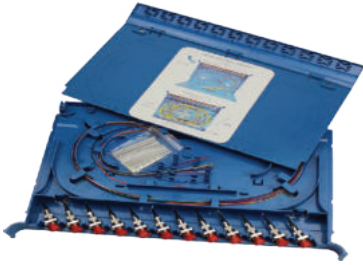

Optical Splice & Distribution Module



Optical Splice & Distribution Module



Optical Splice & Storage Module

## Power Supply



Power Supply Monitoring System



Communication Power Supply 3000W



Communication Power Supply 1800W

## Air Conditioner



Thermoelectric Air Conditioner DC



Enclosure Air Conditioner DC



Enclosure Air Conditioner AC

## Heat Exchanger



Plate Heat Exchanger



Outdoor Cabinet Heat Exchanger



Top Mounting Heat Exchanger

## Rack and Cabinet

### Data center Room



### Micro Data Center

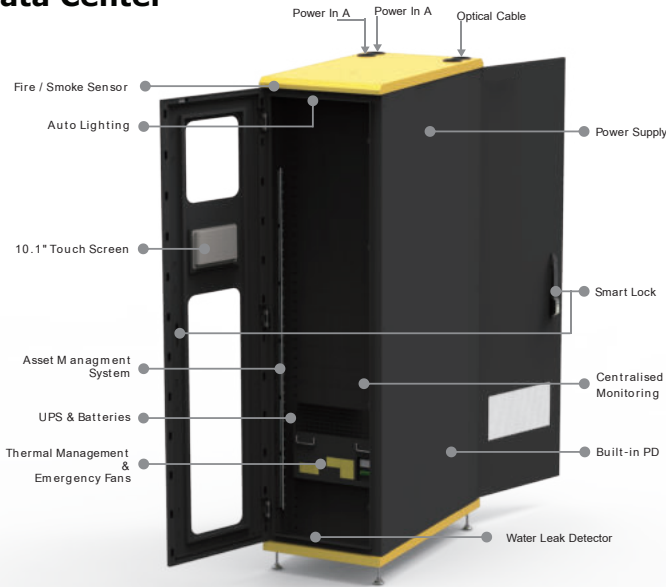

- Micro Data Center**
- Power Supply**
- Thermal Control**
- Rack Supporting**
- Monitoring & Management**

### Outdoor cabinet



Rack Outdoor CCTV



Heavy Wall Rack Outdoor



Outdoor Rack Stand

### Product Focomm

เหมาะสำหรับใช้จัดเก็บอุปกรณ์เครือข่ายคอมพิวเตอร์ หรือเครื่องบันทึกกล้องวงจรปิด และอุปกรณ์ไฟฟ้าอื่นๆ ให้ความสะดวกปลอดภัยในการดูแลรักษาและซ่อมบำรุงอุปกรณ์ภายในตู้ สามารถติดตั้งได้กลางแจ้ง ป้องกันน้ำมาตามมาตรฐาน IP55 ฝาด้านข้างสามารถเปิดได้



# SFP/Media Converter

- Fast Ethernet Media Converter
- Gigabit Ethernet Media Converter
- Media Converter Chassis
- Media POE to Fiber Converter
- Mini Media Converter
- VDO Fiber Converter
- Audio , VGA , DVI , HDMI to Fiber
- FXO/FXS Telephone Voice to Fiber Converter
- 40G QSFP+
- 10G SFP+
- Copper SFP Transceiver
- Active Optical Cable





## Fast Ethernet Media Converter



10/100



10/100 WDM



10/100 SFP

### Features

- Complies with IEEE 802.3, IEEE 802.3u, IEEE 802.3x auto-negotiation
- Optional 19" System Chassis holds up to 14 Media Converters
- Extends distances ranging from 2km (multi-mode fiber) to 120km (single mode fiber)
- Auto-negotiation support on RJ-45 port
- Auto-negotiation of duplex(HDX/FDX) on RJ-45 port
- Auto MDI/MDI-X support on RJ-45 port
- Status LED's for TX,FX LINK/ACT, POWER,100M to easily monitor network status
- External power supply
- Supports packet length up to 1600 bytes

## Gigabit Ethernet Media Converter



10/100/1000



10/100/1000 WDM



10/100/1000 SFP

### Features

- Complies with IEEE 802.3, IEEE 802.3u, IEEE802.3z, IEEE802.3ab, IEEE 802.3x auto-negotiation
- Status LED for easy monitoring of device status
- Extends distances ranging from 550m(multi-mode fiber) to 120km(single-mode fiber)
- Supports auto MDI/MDIX function
- Works at 10Mbps or 100Mbps, full or half-duplex mode, or 1000Mbps full-duplex mode
- Supports jumbo frame size 9K bytes
- External power supply
- Supports independent LFP function

### Ordering Table

PRODUCT	PART NUMBER	DESCRIPTION	PRICE
10/100	MC-F5-02	Media Converter 10/100 Tx SC, MM, 2Km	1,200.00
	MC-F9-25	Media Converter 10/100 Tx SC, SM, 25Km	1,200.00
	MC-F9-40	Media Converter 10/100 Tx SC, SM, 40Km	1,500.00
	MC-F9-60	Media Converter 10/100 Tx SC, SM, 60Km	2,520.00
	MC-F9-80	Media Converter 10/100 Tx SC, SM, 80Km	5,000.00
	MC-F9-100	Media Converter 10/100 Tx SC, SM, 100Km	7,000.00
10/100 with LFP	MC-F9-120	Media Converter 10/100 Tx SC, SM, 120Km	8,000.00
	MC-F5LFP-02	Media Converter 10/100 Tx SC, MM, 2Km	1,500.00
	MC-F9LFP-25	Media Converter 10/100 Tx SC, SM, 25Km	1,500.00
10/100 with LFP management	MC-F9LFP-40	Media Converter 10/100 Tx SC, SM, 40Km	2,000.00
	MC-MG9LFP-40	Media Converter Management 10/100 Tx SC, SM, 40Km	5,000.00
	MC-MG9LFP-80	Media Converter Management 10/100 Tx SC, SM, 80Km	8,000.00
10/100 WDM	MC-FW13-20	Media Converter 10/100 WDM,1310nm Tx, 1550nm Rx, 20Km	Pair 2,500.00
	MC-FW15-20	Media Converter 10/100 WDM,1550nm Tx, 1310nm Rx, 20Km	
	MC-FW13-40	Media Converter 10/100 WDM,1310nm Tx, 1550nm Rx, 40Km	Pair 3,500.00
	MC-FW15-40	Media Converter 10/100 WDM,1550nm Tx, 1310nm Rx, 40Km	
	MC-FW13-80	Media Converter 10/100 WDM,1310nm Tx, 1550nm Rx, 80Km	Pair 4,500.00
	MC-FW15-80	Media Converter 10/100 WDM,1550nm Tx, 1310nm Rx, 80Km	
10/100/1000	MC-G5-00	Media Converter 10/100/1000 Tx-Fx, SC, MM, 550m	2,500.00
	MC-G9-20	Media Converter 10/100/1000 Tx-Fx, SC, SM, 20Km	2,500.00
	MC-G9-40	Media Converter 10/100/1000 Tx-Fx, SC, SM, 40Km	3,500.00
	MC-G9-80	Media Converter 10/100/1000 Tx-Fx, SC, SM, 80Km	8,000.00
10/100/1000 with LFP management	MC-MF9LFP-40	Media Converter Management 10/100/100 Tx SC, SM, 40Km	6,000.00
	MC-MF9LFP-80	Media Converter Management 10/100/100 Tx SC, SM, 80Km	9,000.00
10/100/1000 WDM	MC-GW13-20	Media Converter 10/100/1000 WDM,1310nm Tx, 1550nm Rx, 20Km	Pair 5,500.00
	MC-GW15-20	Media Converter 10/100/1000 WDM,1550nm Tx, 1310nm Rx, 20Km	
	MC-GW13-40	Media Converter 10/100/1000 WDM,1310nm Tx, 1550nm Rx, 40Km	Pair 7,000.00
	MC-GW15-40	Media Converter 10/100/1000 WDM,1550nm Tx, 1310nm Rx, 40Km	
	MC-GW13-80	Media Converter 10/100/1000 WDM,1310nm Tx, 1550nm Rx, 80Km	Pair 18,000.00
	MC-GW15-80	Media Converter 10/100/1000 WDM,1550nm Tx, 1310nm Rx, 80Km	
Media SFP Converter	MC-100-SFP	Media Converter 10/100 Tx-Fx, SFP, SM	1,200.00
	MC-1000-SFP	Media Converter 10/100/1000 Tx-Fx, SFP, SM	2,000.00

บริษัท โฟคคอมม์ (ประเทศไทย) จำกัด

12 ซอยสุขุมวิท 5 ซอย 5 แยก 3 แขวงท่าแร้ง เขตบางเขน กรุงเทพฯ 10220 โทร. 063-391-5262 โทร. 02-557-6451 แฟกซ์. 02-557-6452

www.focomm-cabling.com

## SM to MM Media Converter

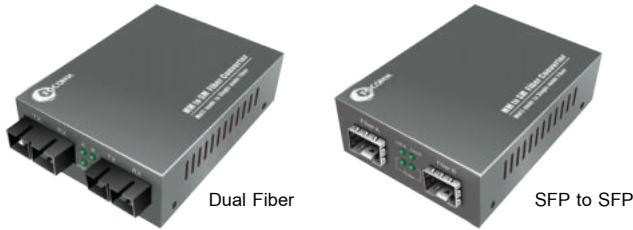

Dual Fiber

SFP to SFP

### Features

- Support 100Base-SX/LX multi-mode to single-mode conversion
- Good for application to extend the network distance
- Standalone or composite applications
- External power supply

## 10G Media Converter



### Features

- Support Jumbo Frame
- Transparent Transport and very low delay
- Support ITUT prescribed DWDM/CWDM wavelength
- Support Loopback test function

## RS-232/485/422 Converter



### Features

- Extend RS-232/485/422 transmission
- Transmit asynchronously, point to point, speed reach 500Kbps
- Examine signal speed automatically, zero delay time
- Plug-and-Play(hot-pluggable, data format auto-sensing & self-adjusting)

## RS-232/485/422 Converter WDM



### Features

- Extend RS-232/485/422 transmission
- Transmit asynchronously, point to point, speed reach 500Kbps
- Examine signal speed automatically, zero delay time
- Plug-and-Play(hot-pluggable, data format auto-sensing & self-adjusting)

## 14/16 Slot Media Converter Chassis



14 Slot Standalone



16 Slot Card-type

### Features

- Accommodates up to 14 or 16 media converters operating under different protocols
- Supports two load sharing, hot swappable power supplies
- 14 slot Supports 10/100Base-TX/FX or 10/100/1000Base-TX/FX standalone serial converters
- 16 slot Supports 10/100Base-TX/FX or 10/100/1000Base-TX/FX card serial converters

## Ordering Table

PRODUCT	PART NUMBER	DESCRIPTION	PRICE
SM to MM Media Converter	MC-F-MM-SM	10/100 multi-mode to single-mode	7,000.00
	MC-G-MM-SM	10/100/1000 multi-mode to single-mode	9,000.00
10G Media Converter	MC-10G-80	10G SFP+ Fiber port to 10GBase-T	15,000.00
	MC-RS5-02	Media Converter RS-232/485/422 transmission to Multi-Mode, 2Km, 9V-36VDC, SC	5,000.00
RS-232/485/422 Converter	MC-RS9-20	Media Converter RS-232/485/422 transmission to Single-Mode, 20Km, 9V-36VDC, SC	6,000.00
	MC-RSW13-20	Media Converter RS-232/485/422 WDM, 1310nm Tx, 1550nm Rx, 20Km	Pair 15,000.00
RS-232/485/422 Converter WDM	MC-RSW15-20	Media Converter RS-232/485/422 WDM, 1550nm Tx, 1310nm Rx, 20Km	
Media Converter Chassis	MC-CH-14	14 Slot Standalone Chassis Rack, Dual power, 220V AC/48V DC	12,000.00
	MC-CH-16	16 Slot Card-type Chassis Rack, Dual power, 220V AC/48V DC	15,000.00

บริษัท โฟคคอมม์ (ประเทศไทย) จำกัด

12 ซอยสุขุมวิท 5 ซอย 5 แยก 3 แขวงท่าแร้ง เขตบางเขน กรุงเทพฯ 10220 โทร. 063-391-5262 โทร. 02-557-6451 แฟกซ์. 02-557-6452

www.focomm-cabling.com

## Media POE to Fiber Converter

1\*100M FX and 1\*10/100/1000M TX with PoE



### Features

- IEEE 802.3at, IEEE 802.3af PoE standard compliance
- Provides DC 48V power over RJ45 Ethernet cable to devices with Ethernet port
- Supports a maximum of 40 watts output power
- Support PD detection and PD classification
- Auto-negotiation of duplex(HDX/FDX) on RJ-45 port
- Auto MDI/MDI-X support on RJ-45 port

### Ordering Table

PRODUCT	PART NUMBER	DESCRIPTION	PRICE
10/100	MC-1POEF540-0.5	10/100M POE Media Converter 10/100/1000M Tx SC, Dual Fiber,MM,40 W, 500m	2,500.00
	MC-1POEF940-20	10/100M POE Media Converter 10/100/1000M Tx SC, Dual Fiber,SM,40 W, 20Km	2,600.00
	MC-1POEF940-40	10/100M POE Media Converter 10/100/1000M Tx SC, Dual Fiber,SM,40 W, 40Km	2,800.00
	MC-1POEF940-80	10/100M POE Media Converter 10/100/1000M Tx SC, Dual Fiber,SM,40 W, 80Km	5,000.00
10/100 WDM	MC-1POEF91340-20	10/100M POE Media Converter 10/100/1000M Tx SC, WDM,1310nm Tx, 1550nm Rx, SM,40 W, 20Km	Pair 5,500.00
	MC-1POEF91540-20	10/100M POE Media Converter 10/100/1000M Tx SC, WDM,1550nm Tx, 1310nm Rx, SM,40 W, 20Km	
	MC-1POEF91340-40	10/100M POE Media Converter 10/100/1000M Tx SC, WDM,1310nm Tx, 1550nm Rx, SM,40 W, 40Km	Pair 6,500.00
	MC-1POEF91540-40	10/100M POE Media Converter 10/100/1000M Tx SC, WDM,1550nm Tx, 1310nm Rx, SM,40 W, 40Km	
	MC-1POEF91340-80	10/100M POE Media Converter 10/100/1000M Tx SC, WDM,1310nm Tx, 1550nm Rx, SM,40 W, 80Km	Pair 12,000.00
	MC-1POEF91540-80	10/100M POE Media Converter 10/100/1000M Tx SC, WDM,1550nm Tx, 1310nm Rx, SM,40 W, 80Km	
10/100 SFP	MC-1POESFP40	10/100M POE Media Converter 10/100/1000M Tx ,SFP,40 W	2,000.00

1\*GE SFP and 1\*10/100/1000M TX with PoE



### Features

- IEEE 802.3at, IEEE 802.3af PoE standard compliance
- Provides DC 48V power over RJ45 Ethernet cable to devices with Ethernet port
- Supports a maximum of 40 watts output power
- Support PD detection and PD classification
- Auto-negotiation of duplex(HDX/FDX) on RJ-45 port
- Auto MDI/MDI-X support on RJ-45 port

### Ordering Table

PRODUCT	PART NUMBER	DESCRIPTION	PRICE
10/100/1000	MC-1POEG540-0.5	10/100/1000M POE Media Converter 10/100/1000M Tx SC, Dual Fiber,MM,40 W, 500m	3,800.00
	MC-1POEG940-20	10/100/1000M POE Media Converter 10/100/1000M Tx SC, Dual Fiber,SM,40 W, 20Km	4,000.00
	MC-1POEG940-40	10/100M POE Media Converter 10/100/1000M Tx SC, Dual Fiber,SM,40 W, 40Km	4,500.00
	MC-1POEG940-80	10/100M POE Media Converter 10/100/1000M Tx SC, Dual Fiber,SM,40 W, 80Km	6,500.00
10/100/1000 WDM	MC-1POEG91340-20	10/100M POE Media Converter 10/100/1000M Tx SC, WDM,1310nm Tx, 1550nm Rx, SM,40 W, 20Km	Pair 8,000.00
	MC-1POEG91540-20	10/100M POE Media Converter 10/100/1000M Tx SC, WDM,1550nm Tx, 1310nm Rx, SM,40 W, 20Km	
	MC-1POEG91340-40	10/100M POE Media Converter 10/100/1000M Tx SC, WDM,1310nm Tx, 1550nm Rx, SM,40 W, 40Km	Pair 9,000.00
	MC-1POEG91540-40	10/100M POE Media Converter 10/100/1000M Tx SC, WDM,1550nm Tx, 1310nm Rx, SM,40 W, 40Km	
	MC-1POEG91340-80	10/100M POE Media Converter 10/100/1000M Tx SC, WDM,1310nm Tx, 1550nm Rx, SM,40 W, 80Km	Pair 14,000.00
	MC-1POEG91540-80	10/100M POE Media Converter 10/100/1000M Tx SC, WDM,1550nm Tx, 1310nm Rx, SM,40 W, 80Km	
10/100/1000 SFP	MC-1POESFP40	10/100/1000M POE Media Converter 10/100/1000M Tx ,SFP,40 W	3,000.00

### หมายเหตุ

ตารางเปรียบเทียบการทำงานในฟังก์ชันที่มี LFP และไม่มี LFP เมื่อทำงานร่วมกับ Ethernet Switch Spanning Tree Protocol ดังนี้

สถานการณ์ที่	ผู้ดูแลระบบ	Switch spanning tree + Media Converter มี LFP		Switch spanning tree + Media Converter ไม่มี LFP	
		สถานการณ์ที่	สถานการณ์ที่	สถานการณ์ที่	สถานการณ์ที่
1 ทำงานปกติ	ระบบมอนิเตอร์ (Switch)	ปกติ	ปกติ	ปกติ	ปกติ
	ผู้ดูแลระบบ (คน)	ปกติ	ปกติ	ปกติ	ปกติ
	ผู้ใช้งาน (คน)	ปกติ	ปกติ	ปกติ	ปกติ
2 ขาด 1 เส้น	ระบบมอนิเตอร์ (Switch)	! พบการเชื่อมต่อผิดพลาด		ปกติ	ปกติ (ไม่แจ้งเตือน)
	ผู้ดูแลระบบ (คน)	! พบการแจ้งเตือน		ปกติ	ปกติ (ต้องซ่อมบำรุง)
	ผู้ใช้งาน (คน)	ปกติ	ปกติ	ปกติ	ปกติ
3 ขาด 2 เส้น	ระบบมอนิเตอร์ (Switch)	สถานการณ์นี้อาจไม่เกิดขึ้นกับเครือข่ายที่ใช้โมดูลชนิด LFP เพราะเมื่อเหตุการณ์ที่ 2 เกิดขึ้น ผู้ดูแลระบบจะรู้ถึงการขาดสาย และเข้าแก้ไขได้ทันที		ปกติ	ปกติ
	ผู้ดูแลระบบ (คน)		ปกติ	ปกติ	ปกติ
	ผู้ใช้งาน (คน)		ปกติ	เสีย	ใช้งานไม่ได้

จากตารางฟังก์ชันของ LFP และ LFS มีวัตถุประสงค์ที่เหมือนกันคือ เมื่อมีพอร์ทหนึ่งพอร์ทใดของ Media Converter ขาดหายไป Media Converter จะต้อง Shut Down อีกพอร์ทที่เหลือนั่นเอง

บริษัท โฟคอมม์ (ประเทศไทย) จำกัด

12 ซอยสุขาภิบาล 5 ซอย 5 แยก 3 แขวงท่าแร้ง เขตบางเขน กรุงเทพฯ 10220 โทร. 063-391-5262 โทร. 02-557-6451 แฟกซ์. 02-557-6452

www.focomm-cabling.com

# Media Converter



## Mini Media Converter

### Duplex Fiber Media Converter



10/100



10/100/1000

#### Features

- Interface: Twisted pair cable: RJ45; Fiber: SC/ST/FC
- 100 base LED: PWR, FX 100, FX Link/Act, FDX, TX 100, TX Link/Act
- Transmission Speed: LAN cable: 10Mbps, 100Mbps, Fiber: 100Mbps
- Duplex Way: Ethernet duplex or half duplex
- Flow control: Full duplex IEEE 802.3x flow control: Half duplex back flow control
- Environment Temperature : -20~65°C
- Storage Temperature : -20~70°C

### Single Fiber Media Converter



10/100 WDM



10/100/1000 WDM

#### Features

- Interface: Twisted pair cable: RJ45; Fiber: SC/ST/FC
- 100 base LED: PWR, FX 100, FX Link/Act, FDX, TX 100, TX Link/Act
- Transmission Speed: LAN cable: 10Mbps, 100Mbps, Fiber: 100Mbps
- Duplex Way: Ethernet duplex or half duplex
- Flow control: Full duplex IEEE 802.3x flow control: Half duplex back flow control
- Environment Temperature : -20~65°C
- Storage Temperature : -20~70°C

### Media Converter Power Tray



#### Features

- Trays qty: 18.
- The power supply output ripple and noise is less than 50mV.
- Power supply: can choose single or dual supply.
- Good heat dissipation design, to ensure the normal operation of equipment.
- Application of WT series transceiver (10M, 100M, 100M, 10/100M adaptive)

#### Ordering Table

PRODUCT	PART NUMBER	DESCRIPTION	PRICE
10/100	MCM-F5-02	Mini Media Converter 10/100 Tx SC, MM, 2Km	1,600.00
	MCM-F9-20	Mini Media Converter 10/100 Tx SC, SM, 20Km	1,800.00
10/100 WDM	MCM-FW13-20	Mini Media Converter 10/100 WDM 1310nm Tx, 1550nm RX, 20Km	Pair 4,000.00
	MCM-FW15-20	Mini Media Converter 10/100 WDM, 1550nm Tx, 1310nm Rx, 20Km	
10/100/1000	MCM-G5-02	Mini Media Converter 10/100/1000 Tx SC, MM, 2Km	3,500.00
	MCM-G9-20	Mini Media Converter 10/100/1000 Tx SC, SM, 20Km	3,500.00
10/100/1000 WDM	MCM-GW-13-20	Mini Media Converter 10/100/1000 WDM, 1310nm Tx, 1550nm Rx, 20Km	Pair 8,000.00
	MCM-GW-15-20	Mini Media Converter 10/100/1000 WDM, 1550nm Tx, 1310nm Rx, 20Km	
Media Converter Power Tray	MCM-CH-18	18 Slot Media converter rackmount chasis, 12V, 1.5U height	17,000.00

บริษัท โฟคอมม (ประเทศไทย) จำกัด

12 ซอยสุขุมวิท 5 ซอย 5 แยก 3 แขวงท่าแร้ง เขตบางเขน กรุงเทพฯ 10220 โทร. 063-391-5262 โทร. 02-557-6451 แฟกซ์. 02-557-6452

www.focomm-cabling.com



# Media Converter

## VDO Fiber Converter



### Description

Focomm series video optical transceiver adopts the advanced digital video and optical fiber transmission technology, and implement the real-time transmission & synchronization, no-distortion and high quality 1-channel video signal on this single fiber. 1, 2, 4, 8, 16, 32, 64 channel video optical transceiver adopts the full digital video non-compression transmission technology and high quality video effect, which can meet the user's requirements; the play-and-plug design makes the installation more convenient and easier.

### Features

- 8/10-bit digital code and non-compression type video transmission
- Support any high-resolution video signal
- 5Hz-10MHz video channel
- Automatic compatible PAL, NTSC and SECAM video system
- With APC circuit, constant input optical power, and large dynamic range
- Kilomega optical fiber transmission, large capacity, and easy to upgrade
- Power supply and other parameter state indication, which can monitor the operation condition of system
- Support no-damage regenerative trunk of video
- Advanced self-adapting technology, and it is unnecessary to implement the adjustment of spot electrics or optics when using
- Industry-grade design and modularization design make the equipment reliable and flexible

### Ordering Table

PRODUCT	PART NUMBER	DESCRIPTION	PRICE
VDO Fiber Converter	VDC-1V1D-FC20T/R-1080	1 CH 1080P TVI/CVI/AHD Video Converter, WDM, RS485 Data, 20 Km, FC	Pair 4,100.00
	VDC-2V1D-FC20T/R-1080	2 CH 1080P TVI/CVI/AHD Video Converter, WDM, RS 485 Data, 20 Km, FC	Pair 6,600.00
	VDC-4V1D-FC20T/R-1080	4 CH 1080P TVI/CVI/AHD Video Converter, WDM, RS 485 Data, 20 Km, FC	Pair 9,000.00
	VDC-8V1D-FC20T/R-1080	8 CH 1080P TVI/CVI/AHD Video Converter, WDM, RS 485 Data, 20 Km, FC	Pair 20,200.00
	VDC-16V1D-FC20T/R-1080	16 CH 1080P TVI/CVI/AHD Video Converter, WDM, RS 485 Data 20 Km, FC	Pair 51,000.00
	VDC-32V1D-FC20T/R-1080	32 CH 1080P TVI/CVI/AHD Video Converter, WDM, RS 485 Data 20 Km, FC	Pair 90,000.00
	VDC-64V1D-FC20T/R-1080	64 CH 1080P TVI/CVI/AHD Video Converter, WDM, RS 485 Data 20 Km, FC	Pair 180,000.00

## Audio to Fiber Converter



1 CH



2 CH



4 CH



8 CH



16 CH

### Features

- 1,2,4,8,16 Channel bidirectional Audio RCA to Fiber Optic Converter 20km

## VGA to Fiber Converter

### VGA Fiber converter



### VGA + KVM(USB) Fiber converter



### Features

- Through a one core single mode fiber can transmit one-way VGA video, stereo audio signals
- Support for up to VGA resolution up to 1080P / 60HZ

## DVI to Fiber Converter

### DVI Fiber converter



### DVI + KVM(USB) Fiber converter



### Features

- Support for up to DVI resolution up to 1080P / 60HZ
- Optical fiber transmission distance up to 20KM
- The device supports DVI, Audio Interface

### Features

- Optical fiber transmission distance up to 20KM
- The device supports DVI, Audio Interface
- Support for KVM, USB mouse and keyboard to remotely control

## Ordering Table

PRODUCT	PART NUMBER	DESCRIPTION	PRICE
Audio to Fiber Converter	MC-A-1AVT/R-F9-20	1 CH Audio, RCA, SM, WDM, 20Km, FC	Pair 3,500.00
	MC-A-2AVT/R-F9-20	2 CH Audio, RCA, SM, WDM, 20Km, FC	Pair 4,000.00
	MC-A-4AVT/R-F9-20	4 CH Audio, RCA, SM, WDM, 20Km, FC	Pair 7,000.00
	MC-A-8AVT/R-F9-20	8 CH Audio, RCA, SM, WDM, 20Km, FC	Pair 16,000.00
	MC-A-16AVT/R-F9-20	16 CH Audio, RCA, SM, WDM, 20Km, FC	Pair 30,000.00
VGA to Fiber Converter	H-VGAT/R-F9-20	VGA to Fiber Converter, SM 20Km, WDM, SC	Pair 5,000.00
	H-VGAT/R-USB-F9-20	VGA to Fiber Converter with USB, SM 20Km, WDM, SC	Pair 6,000.00
DVI to Fiber Converter	H-DVIT/R-F9-20	DVI to Fiber Converter, SM 20Km, WDM, SC	Pair 7,500.00
	H-DVIT/R-USB-F9-20	DVI to Fiber Converter with USB, SM 20Km, WDM, SC	Pair 10,000.00

## HDMI TO Fiber Optic

HDMI Fiber converter



### Features

- Transmits HDMI video and audio signals up to 20km over one fiber optic cable
- Support video resolution up to 1920\*1080@60Hz
- Compliance with HDMI 1.3 and HDCP 1.2 standard

HDMI fiber converter + extender



### Features

- Transmits HDMI video and audio signals up to 20km over one fiber optic cable
- Support video resolution up to 1920\*1080@60Hz
- Compliance with HDMI 1.3 and HDCP 1.2 standard

HDMI with USB Uncompressed lossless



### Features

- T HDMI video signal Uncompressed lossless and non-delay transmission.
- Support KVM signal control mouse keyboard
- Compliance with HDMI 1.3 and HDCP 1.2 standard
- Support video resolution up to 1920\*1080@60Hz

HDMI +KVM(USB) Fiber converter



### Features

- Transmits HDMI video and audio signals up to 20km over one fiber optic cable
- Support video resolution up to 1920\*1080@60Hz
- Compliance with HDMI 1.3 and HDCP 1.2 standard

HDMI Uncompressed lossless



### Features

- HDMI transmitter 1 channel HDMI signal input and 1 channel HDMI signal 1 channel audio stereo loop out, HDMI receiver 1 channel HDMI signal and 1 channel audio signal output.

## FXO/FXS Telephone Voice Fiber Converter



1 CH



2 CH



4 CH



8 CH



16 CH

### Features

- FXO/FXS 1,2,4,8,16 channel telephone voice with 1 -CH 100M Ethernet fiber converter

### Ordering Table

PRODUCT	PART NUMBER	DESCRIPTION	PRICE
HDMI TO Fiber Optic	MC-H-HDMI-F9-20	HDMI Fiber converter, 20Km, WDM	Pair 5,500.00
	MC-H-HDMI-F9-20	HDMI +KVM(USB) Fiber converter, 20Km, WDM	Pair 8,000.00
	MC-H-HDMI-EX-F9-20	HDMI fiber converter + extender, 20Km, WDM	Pair 8,500.00
	MC-H-HDMI-EX-LL-F9-20	HDMI Uncompressed lossless, non-delay over fiber converter extender, 20Km, WDM	Pair 9,000.00
	MC-H-HDMI-USB-EX-LL-F9-20	HDMI with USB Uncompressed lossless and non-delay to fiber converter extender, 20Km, WDM	Pair 11,000.00
FXO/FXS Telephone Voice	MC-PCM-1V1L-F9-20	FXO/FXS 1-channel telephone voice with 1 -CH 100M Ethernet fiber converter	Pair 4,000.00
	MC-PCM-2V1L-F9-20	FXO/FXS 2-channel telephone voice with 1 -CH 100M Ethernet fiber converter	Pair 4,500.00
	MC-PCM-4V1L-F9-20	FXO/FXS 4-channel telephone voice with 1 -CH 100M Ethernet fiber converter	Pair 5,500.00
	MC-PCM-8V1L-F9-20	FXO/FXS 8-channel telephone voice with 1 -CH 100M Ethernet fiber converter	Pair 7,500.00
	MC-PCM-16V1L-F9-20	FXO/FXS 16-channel telephone voice with 1 -CH 100M Ethernet fiber converter	Pair 14,000.00



**40G QSFP+**

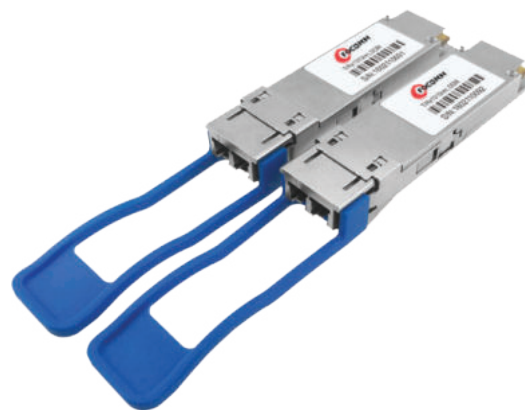

**Ordering Table**

Model	Rate	Wavelength	Distance	Optical power	Sensitivity	Other	Price
MC-QSFP+-40G-SR4	40Gbps	850nm	150m	-7.6~1dBm	<-9.5dBm	MPO/MMF	5,000.00
MC-QSFP+-40G-ESR4	40Gbps	850nm	300m	-7.3~1dBm	<-9.9dBm	MPO/MMF	7,000.00
MC-QSFP+-40G-IR4-PSM	40Gbps	1310nm	2km	-7.6~0.5dBm	<-11.5dBm	MPO/SMF	20,000.00
MC-QSFP+-40G-LR4-PSM	40Gbps	1310nm	10km	-6~-1dBm	<-12.6dBm	MPO/SMF	22,000.00
MC-QSFP+-40G-IR4	40Gbps	CWDM	2km	-7~-2.4dBm	<-11.7dBm	2xLC/SMF	20,000.00
MC-QSFP+-40G-LR4	40Gbps	CWDM	10km	-7~-2.3dBm	<-13.7dBm	2xLC/SMF	22,000.00

บริษัท โฟค้อมม (ประเทศไทย) จำกัด

12 ซอยสุขุมวิท 5 ซอย 5 แยก 3 แขวงท่าแร้ง เขตบางเขน กรุงเทพฯ 10220 โทร. 063-391-5262 โทร. 02-557-6451 แฟกซ์. 02-557-6452

[www.focomm-cabling.com](http://www.focomm-cabling.com)



## 10G SFP+



Ordering Table / Double Fiber

Model	Rate	Wavelength	Distance	Optical power	Sensitivity	DDM/DOM	Price
MC-SFP+10GB-SR	10G	850nm	300m	-8.2~-1dBm	<-9.9dBm	Yes	1,400.00
MC-SFP+10GB-LR	10G	1310nm	10km	-6~-0.5dBm	<-14.4dBm	Yes	2,000.00
MC-SFP+10GB-ER	10G	1550nm	40km	-1~2dBm	<-14.4dBm	Yes	12,000.00
MC-SFP+10GB-ZR	10G	1550nm	80km	0~4dBm	<-23dBm	Yes	22,000.00

Ordering Table / Single Fiber

Model	Rate	Wavelength	Distance	Optical power	Sensitivity	DDM/DOM	Price
MC-SFP+ BIDI-12-10D	10G	1270nm	10km	-6~-1dBm	<-15dbm	Yes	8,000.00
MC-SFP+ BIDI-13-10D	10G	1330nm	10km	-6~-1dbm	<-15dBm	Yes	8,000.00
MC-SFP+ BIDI-12-40D	10G	1270nm	40km	-1~4dBm	<-16.5dbm	Yes	9,000.00
MC-SFP+ BIDI-13-40D	10G	1330nm	40km	-1~4dbm	<-16.5dBm	Yes	9,000.00

Ordering Table / CWDM/DWDM

Model	Rate	Wavelength	Distance	Optical power	Sensitivity	DDM/DOM	Price
MC-SFP+ CWDM-XX-40D <sup>Note1</sup>	10G	CWDM <sup>Note2</sup>	40km	-1~4dBm	<-15.5dBm	Yes	30,000.00
MC-SFP+ CWDM-XX-80D <sup>Note1</sup>	10G	CWDM <sup>Note2</sup>	80km	0~5dBm	<-23.5dBm	Yes	34,000.00
MC-SFP+ DWDM-XX-40D <sup>Note3</sup>	10G	DWDM <sup>Note3</sup>	40km	-1~4dBm	<-15.5dBm	Yes	30,000.00
MC-SFP+ DWDM-XX-80D <sup>Note3</sup>	10G	DWDM <sup>Note3</sup>	80km	0~5dBm	<-23dBm	Yes	36,000.00

## 10G XFP



Ordering Table / Double Fiber

Model	Rate	Wavelength	Distance	Optical power	Sensitivity	DDM/DOM	Price
MC-XFP-10GB-SR	10G	850nm	300m	-7.1~-3dBm	<-11dBm	Yes	3,500.00
MC-XFP-10GB-LR	10G	1310nm	10km	-6~-1dBm	<-13dBm	Yes	4,000.00
MC-XFP-10GB-ER	10G	1550nm	40km	-4~2dBm	<-16dBm	Yes	12,000.00
MC-XFP-10GB-ZR	10G	1550nm	80km	-2~5dBm	<-23dBm	Yes	30,000.00

Ordering Table / Single Fiber

Model	Rate	Wavelength	Distance	Optical power	Sensitivity	DDM/DOM	Price
MC-XFP-BIDI-12-10D	10G	1270nm	10km	-6~-1dBm	<-15dbm	Yes	12,000.00
MC-XFP-BIDI-13-10D	10G	1330nm	10km	-6~-1dBm	<-15dbm	Yes	12,000.00
MC-XFP-BIDI-12-40D	10G	1270nm	40km	-1~4dBm	<-16.5dbm	Yes	15,000.00
MC-XFP-BIDI-13-40D	10G	1330nm	40km	-1~4dBm	<-16.5dbm	Yes	15,000.00

Ordering Table / CWDM/DWDM

Model	Rate	Wavelength	Distance	Optical power	Sensitivity	DDM/DOM	Price
MC-XFP-CWDM-xx-40D <sup>Note1</sup>	10G	CWDM <sup>Note2</sup>	40km	-1~4dBm	<-16.5dBm	Yes	36,000.00
MC-XFP-CWDM-xx-80D <sup>Note1</sup>	10G	CWDM <sup>Note2</sup>	80km	0~5dBm	<-24dBm	Yes	40,000.00
MC-XFP-DWDM-xx-40D <sup>Note3</sup>	10G	DWDM <sup>Note3</sup>	40km	-1~4dBm	<-16.5dBm	Yes	36,000.00
MC-XFP-DWDM-xx-80D <sup>Note3</sup>	10G	DWDM <sup>Note3</sup>	80km	0~5dBm	<-24dBm	Yes	54,000.00

**Note**

1. XX refers to CWDM Wavelength range 1470nm to 1610nm, XX=47~61 means 1470nm to 1610nm.
2. Wavelength from 1470nm to 1610nm, each step 20nm. Please contact Optone to confirm the wavelength availability.
3. XX refers to DWDM Wavelength channel as ITU-T specified, Please contact Focomm to confirm the wavelength availability.

**บริษัท โฟคอมม (ประเทศไทย) จำกัด**

12 ซอยสุขุมวิท 5 ซอย 5 แยก 3 แขวงท่าแร้ง เขตบางเขน กรุงเทพฯ 10220 โทร. 063-391-5262 โทร. 02-557-6451 แฟกซ์. 02-557-6452

[www.focomm-cabling.com](http://www.focomm-cabling.com)

## 155M ~ 2.67CWDM SFP



### Ordering Table

Model	Rate	Wavelength	Distance	Optical power	Sensitivity	DDM/DOM	Price
MC-SFP-CWDM-SM-01xx	155M	CWDM	40km	-5~0dBm	<-33dBm	Yes	5,000.00
MC-SFP-CWDM-SM-01xx	155M	CWDM	80km	-5~0dBm	<-34dBm	Yes	4,000.00
MC-SFP-CWDM-SM-02xx	1.25G	CWDM	40km	-5~0dBm	<-24dBm	Yes	6,000.00
MC-SFP-CWDM-SM-02xx	1.25G	CWDM	80km	0~5dBm	<-24dBm	Yes	4,500.00
MC-SFP-CWDM-SM-03xx	2.5G	CWDM	40km	0~5dBm	<-18dBm	Yes	10,000.00
MC-SFP-CWDM-SM-03xx	2.5G	CWDM	80km	0~5dBm	<-28dBm	Yes	9,000.00

### Note

- xx refers to CWDM Wavelength range 1270nm to 1610nm, xx=27~61 means 1270nm to 1610nm
- Wavelengths from 1270nm to 1610nm, each step 20nm

## 155m ~ 2.67G SFP



### Ordering Table / Double Fiber

Model	Rate	Wavelength	Distance	Optical power	Sensitivity	DDM/DOM	Price
MC-SFP-SX-MM-0102	155M	1310nm	2km	-18~-10dbm	<-32dbm	Yes	800.00
MC-SFP-LX-SM-0120	155M	1310nm	20km	-15~-8dbm	<-33dbm	Yes	700.00
MC-SFP-LX-SM-0140	155M	1310nm	40km	-9~-3dBm	<-33dBm	Yes	1,000.00
MC-SFP-ZX-SM-0160	155M	1550nm	60km	-5~0dBm	<-34dBm	Yes	3,000.00
MC-SFP-ZX-SM-0180	155M	1550nm	80km	0~5dBm	<-34dBm	Yes	3,400.00
MC-SFP-SX-MM-0605	622M	850nm	550m	-9~-3dBm	<-17dBm	Yes	1,000.00
MC-SFP-LX-SM-0620	622M	1310nm	20km	-14~-8dBm	<-28dBm	Yes	1,200.00
MC-SFP-LX-SM-0640	622M	1310nm	40km	-3~-2dBm	<-28dBm	Yes	1,800.00
MC-SFP-ZX-SM-0680	622M	1550nm	80km	-3~-2dBm	<-28dBm	Yes	4,000.00
MC-SFP-SX-MM-0205	1.25G	850nm	550m	-9~-3dBm	<-17dBm	Yes	800.00
MC-SFP-LX-SM-0210	1.25G	1310nm	10km	-9~-3dBm	<-22dBm	Yes	800.00
MC-SFP-LX-SM-0240	1.25G	1310nm	40km	-5~0dBm	<-24dBm	Yes	1,000.00
MC-SFP-ZX-SM-0280	1.25G	1550nm	80km	0~5dBm	<-25dBm	Yes	3,000.00
MC-SFP-ZX-SM-02120	1.25G	1550nm	120km	0~5dBm	<-32dBm	Yes	10,000.00
MC-SFP-SX-MM-0303	2.5G	850nm	300m	-9~-3dBm	<-18dBm	Yes	1,500.00
MC-SFP-LX-SM-0302	2.5G	1310nm	2km	-9~-3dBm	<-18dBm	Yes	2,000.00
MC-SFP-LX-SM-0315	2.5G	1310nm	15km	-5~0dBm	<-18dBm	Yes	2,500.00
MC-SFP-LX-SM-0340	2.5G	1310nm	40km	-2~-3dBm	<-18dBm	Yes	3,000.00
MC-SFP-ZX-SM-0380	2.5G	1550nm	80km	0~5dBm	<-28dBm	Yes	7,000.00
MC-SFP-ZX-SM-03120	2.5G	1550nm	120km	2~7dBm	<-28dBm	Yes	15,000.00

บริษัท โฟคคอมม์ (ประเทศไทย) จำกัด

12 ซอยสุขาภิบาล 5 ซอย 5 แยก 3 แขวงท่าแร้ง เขตบางเขน กรุงเทพฯ 10220 โทร. 063-391-5262 โทร. 02-557-6451 แฟกซ์. 02-557-6452

www.focomm-cabling.com

## 155m ~ 2.67G BIDI SFP



Ordering Table / Single Fiber

Model	Rate	Wavelength	Distance	Optical power	Sensitivity	DDM/DOM	Price
MC-SFP-WDM-SM-0120A	155M	1550nm	20km	-15~-8dbm	<-33dbm	Yes	2,000.00
MC-SFP-WDM-SM-0120B	155M	1310nm	20km	-15~-8dbm	<-33dbm	Yes	2,000.00
MC-SFP-WDM-SM-0140A	155M	1550nm	40km	-9~-3dBm	<-33dbm	Yes	3,000.00
MC-SFP-WDM-SM-0140B	155M	1310nm	40km	-9~-3dBm	<-33dbm	Yes	3,000.00
MC-SFP-WDM-SM-0160A	155M	1550nm	60km	-5~0dBm	<-34dbm	Yes	7,000.00
MC-SFP-WDM-SM-0160B	155M	1490nm	60km	-5~0dBm	<-34dbm	Yes	7,000.00
MC-SFP-WDM-SM-0180A	155M	1550nm	80km	-5~0dBm	<-34dbm	Yes	7,500.00
MC-SFP-WDM-SM-0180B	155M	1490nm	80km	-5~0dBm	<-34dbm	Yes	7,500.00
MC-SFP-WDM-SM-0203A	1.25G	1550nm	3km	-9~-3dBm	<-21dBm	Yes	1,500.00
MC-SFP-WDM-SM-0203B	1.25G	1310nm	3km	-9~-3dBm	<-21dBm	Yes	1,500.00
MC-SFP-WDM-SM-0220A	1.25G	1550nm	20km	-9~-3dBm	<-22dBm	Yes	2,000.00
MC-SFP-WDM-SM-0220B	1.25G	1310nm	20km	-9~-3dBm	<-22dBm	Yes	2,000.00
MC-SFP-WDM-SM-0240A	1.25G	1550nm	40km	-5~0dBm	<-23dBm	Yes	2,500.00
MC-SFP-WDM-SM-0240B	1.25G	1310nm	40km	-5~0dBm	<-23dBm	Yes	2,500.00
MC-SFP-WDM-SM-0260A	1.25G	1550nm	60km	-2~-3dBm	<-24dBm	Yes	4,500.00
MC-SFP-WDM-SM-0260B	1.25G	1490nm	60km	-2~-3dBm	<-24dBm	Yes	4,500.00
MC-SFP-WDM-SM-0280A	1.25G	1550nm	80km	0~5dBm	<-24dBm	Yes	5,000.00
MC-SFP-WDM-SM-0280B	1.25G	1490nm	80km	0~5dBm	<-24dBm	Yes	5,000.00
MC-SFP-WDM-SM-02120A	1.25G	1550nm	120km	0~5dBm	<-32dBm	Yes	10,000.00
MC-SFP-WDM-SM-02120B	1.25G	1490nm	120km	0~5dBm	<-32dBm	Yes	10,000.00
MC-SFP-WDM-SM-0320A	2.5G	1550nm	20km	-5~0dBm	<-18dBm	Yes	8,000.00
MC-SFP-WDM-SM-0320B	2.5G	1310nm	20km	-5~0dBm	<-18dBm	Yes	8,000.00
MC-SFP-WDM-SM-0340A	2.5G	1550nm	40km	-2~-3dBm	<-20dBm	Yes	9,000.00
MC-SFP-WDM-SM-0340B	2.5G	1310nm	40km	-2~-3dBm	<-20dBm	Yes	9,000.00
MC-SFP-WDM-SM-0380A	2.5G	1550nm	80km	0~5dBm	<-28dBm	Yes	12,000.00
MC-SFP-WDM-SM-0380B	2.5G	1490nm	80km	0~5dBm	<-28dBm	Yes	12,000.00

## Copper SFP Transceiver



Ordering Table

Model	Rate	Distance	Connecter	Price
MC-GLC-T-A	1000M	100m	RJ45	2,000.00
MC-GLC-T-B	10/100/1000M	100m	RJ45	2,000.00
MC-SFP+-T	10G	30m	RJ45	9,000.00

บริษัท โฟคคอมม์ (ประเทศไทย) จำกัด

12 ซอยสุขาภิบาล 5 ซอย 5 แยก 3 แขวงท่าแร้ง เขตบางเขน กรุงเทพฯ 10220 โทร. 063-391-5262 โทร. 02-557-6451 แฟกซ์. 02-557-6452

www.focomm-cabling.com

## ACTIVE OPTICAL CABLE

### 10G SFP+ AOC



#### Features

- Complies with IEEE802.3, IEEE802.3u standard
- Supports IEEE802.3at, IEEE802.3af PoE standard
- Support PD detection and PD classification
- Provides 6-port 10/100M RJ45 and 2-port fiber ports
- Supports auto duplex(HDX/FDX) auto MDI/MDIX function
- Auto MDI/MDI-X support on RJ-45 port

#### Ordering Table

PRODUCT	PART NUMBER	DESCRIPTION	PRICE
ACTIVE OPTICAL CABLE	MC-OPT-SFP+-AOC-1	1 meter 10G SFP+ ActiveOptical Cable	3,000.00
	MC-OPT-SFP+-AOC-3	3 meter 10G SFP+ ActiveOptical Cable	3,200.00
	MC-OPT-SFP+-AOC-5	5 meter 10G SFP+ ActiveOptical Cable	3,400.00
	MC-OPT-SFP+-AOC-7	7 meter 10G SFP+ ActiveOptical Cable	3,600.00

### 40G QSFP+ AOC



#### Features

- 4 channels full-duplex 850nm parallel active optical cable
- Transmission data rate up to 10.3Gbps per channel
- 4 channels 850nm VCSEL array
- 4 channels PIN photo-detector array
- SFF-8436 QSFP+ compliant
- Hot-pluggable electrical interface

#### Ordering Table

PRODUCT	PART NUMBER	DESCRIPTION	PRICE
ACTIVE OPTICAL CABLE	MC-OPT-QSFP+-AOC-3	3 meter 40G QSFP+ Active Optical Cable	9,000.00
	MC-OPT-QSFP+-AOC-5	5 meter 40G QSFP+ Active Optical Cable	9,200.00
	MC-OPT-QSFP+-AOC-10	10 meter 40G QSFP+ Active Optical Cable	9,600.00
	MC-OPT-QSFP+-AOC-20	20 meter 40G QSFP+ Active Optical Cable	11,000.00

### 10G SFP+ DAC



#### Features

- Support for multi-gigabit data rates up to 10.5Gb/s
- Data rates backward compatible to 1Gb/s
- Hot-pluggable SFP+ 20PIN footprint
- Improved Pluggable Form-factor (IPF) compliant
- Compliant to SFP+ MSA
- Operating case temperature range 0°C to +70°C

#### Ordering Table

PRODUCT	PART NUMBER	DESCRIPTION	PRICE
ACTIVE OPTICAL CABLE	MC-OPT-SFP+-DAC-1	1 meter 10G SFP+ ActiveOptical Cable	1,000.00
	MC-OPT-SFP+-DAC-3	3 meter 10G SFP+ ActiveOptical Cable	1,400.00
	MC-OPT-SFP+-DAC-5	5 meter 10G SFP+ ActiveOptical Cable	1,800.00
	MC-OPT-SFP+-DAC-7	7 meter 10G SFP+ ActiveOptical Cable	2,200.00

### 40G QSFP+ DAC



#### Features

- 4-channel full-duplex passive copper cable
- SFF-8436 compliant QSFP+ connectors
- SFF-8636 compliant I2C management interface
- IEEE 802.3ba 40GBASE-CR4 compliant
- Data rate up to 40Gbps (4x 10Gbps)
- Copper link length up to 5m (passive limiting)

#### Ordering Table

PRODUCT	PART NUMBER	DESCRIPTION	PRICE
ACTIVE OPTICAL CABLE	MC-OPT-QSFP+-DAC-30-P1	1 meter 40G QSFP+ Passive Copper Cable 30AWG	2,000.00
	MC-OPT-QSFP+-DAC-30-P2	2 meter 40G QSFP+ Passive Copper Cable 30AWG	2,500.00
	MC-OPT-QSFP+-DAC-30-P3	3 meter 40G QSFP+ Passive Copper Cable 30AWG	3,200.00
	MC-OPT-QSFP+-DAC-28-P5	5 meter 40G QSFP+ Passive Copper Cable 28AWG	4,000.00



## Media Converter Solution

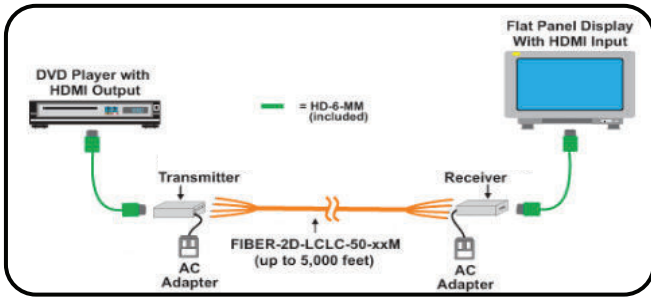

### Product Focomm

#### HDMI TO Fiber Optic

- ขยายสัญญาณ HDMI สูงถึง 20 กิโลเมตรผ่านสาย Optical เพียงเส้นเดียว
- รองรับความละเอียดสูงสุดถึง 1080p @ 30Hz
- ไฟ LED แสดงสถานะของพลังงานและการเชื่อมต่อ USB ได้อย่างง่ายดาย
- รองรับฟังก์ชัน KVM, การควบคุมระยะไกลได้อย่างสะดวก

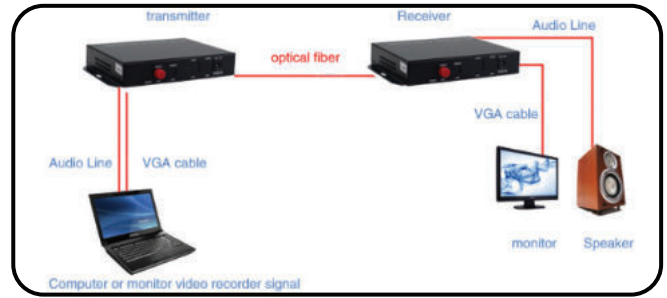

### Product Focomm

#### Audio to Fiber Converter

- เชื่อมต่อ RCA
- ความต้านทานอินพุต 600 Ohm 47K
- ความต้านทานเอาต์พุต 600 Ohm10K

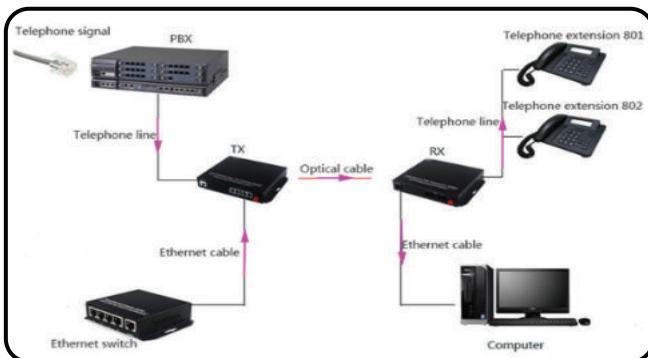

### Product Focomm

#### PCM to Fiber Converter

- เสียงคุณภาพสูง fxs / fxo POTS ไฟเบอร์มัลติเพล็กซ์เซอร์
- โยแก้วนำแสงสูญเสียการเชื่อมโยงสูงสุดโมโนโหมดเดียวที่อนุญาตคือ 18dB
- การสูญเสียการเชื่อมโยงสูงสุด 62.5 / 125 มม. โยแก้วนำแสงคือ 12dB ไทร์คัพที่ 4 ช่อง



### Product Focomm

#### VGA to Fiber Converter

- ไฟเบอร์ 1 core สามารถส่งสัญญาณวิดีโอ VGA แบบทิศทางเดียว เสียง สเตอริโอและสัญญาณ KVM ได้
- รองรับความละเอียดสูงสุดถึง VGA สูงถึง 1080p / 60HZ
- ระยะการส่งผ่านโยแก้วนำแสงสูงถึง 20KM
- อุปกรณ์รองรับ VGA, Audio Interface
- รองรับ KVM, เม้าส์ USB และคีย์บอร์ดเพื่อควบคุมจากระยะไกล

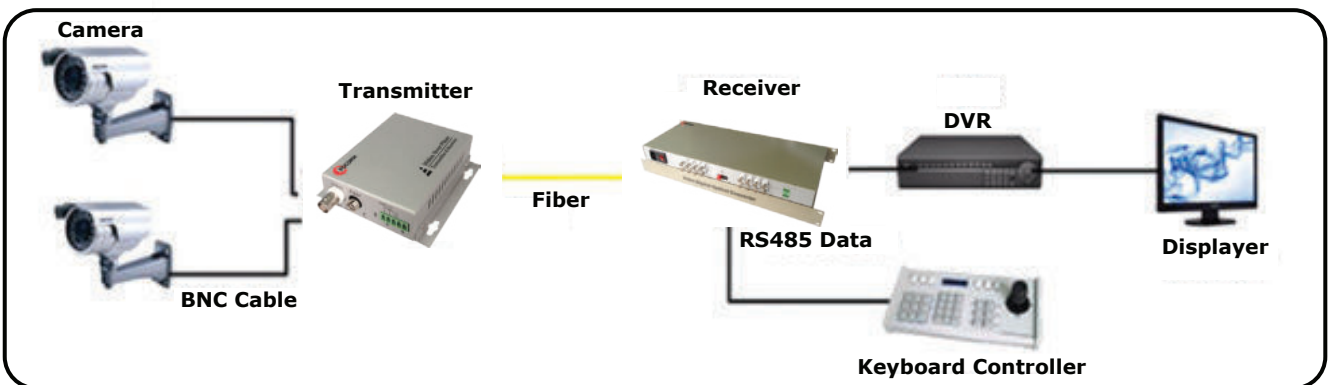

### Product Focomm

#### VDO Fiber Converter

- ประเภทCardหรือโครงสร้างที่เป็นอิสระซึ่งถูกนำไปใช้กับตัวถึง 2.5U การจัดกรแบบรวมศูนย์
- รหัสดิจิทัล 8/10 บิตและการส่งผ่านวิดีโอแบบไม่มีข้อขัด
- รองรับสัญญาณวิดีโอความละเอียดสูง
- ช่องวิดีโอ 5Hz-10MHz
- ระบบวิดีโอ PAL, NTSC และ SECAM ที่เข้ากันได้โดยอัตโนมัติ
- ตัววงจร APC พลังงานแสงที่ป้อนเข้ามาอย่างต่อเนื่อง
- การส่งผ่านโยแก้วนำแสง Kilometa ความจุขนาดใหญ่และง่ายต่อการอัพเกรด
- แหล่งจ่ายไฟและสถานะพารามิเตอร์อื่น ๆ ซึ่งสามารถตรวจสอบสภาพการทำงานของระบบ
- สนับสนุนลำดับต้นการสร้างวิดีโอที่ไม่เสียหาย
- เทคโนโลยีการปรับตัวเองขั้นสูงและไม่จำเป็นต้องปรับใช้สปอตไฟฟ้าหรือเลนส์เมื่อใช้
- การออกแบบในระดับอุตสาหกรรมและการออกแบบแบบแยกส่วนทำให้อุปกรณ์มีความน่าเชื่อถือและยืดหยุ่น

บริษัท โฟคอมม์ (ประเทศไทย) จำกัด

12 ซอยสุขาภิบาล 5 ซอย 5 แยก 3 แขวงท่าแร้ง เขตบางเขน กรุงเทพฯ 10220 โทร. 063-391-5262 โทร. 02-557-6451 แฟกซ์. 02-557-6452

www.focomm-cabling.com



# PoE Switch Product

- POE Switch 10/100 M
- POE Switch Unmanaged 10/100/1000 M
- POE Switch Managed 10/100/1000 M
- Fiber Optic Switch
- POE Injector/POE Splitter
- Unmanaged Industrial POE+ Switch
- Unmanaged Industrial Switch
- Managed Industrial POE Switch
- Managed Industrial Switch



## PoE Switch 10/100 M

Unmanaged PoE switch 6 Port.



### Features

- 4\*10/100M PoE ports +2\*10/100M uplink RJ45 ports , Port 3-6 can support IEEE 802.3af/at PoE standard .Adjust function switch,
- 3-6 port VLAN isolation or 10M/250m long distance transmission,
- external 65W power supply. external 65W power supply.

Unmanaged PoE Switch 10Port, 110W.



### Features

- 8\*10/100M PoE port+2\*10/100/1000M RJ45 port PoE switch, port1-8 support IEEE 802.3af/at PoE international standard.
- total power is 110W.
- external power supply.

Unmanaged PoE Switch 10Port, 250W.



### Features

- 8\*10/100M PoE port+2\*10/100/1000M RJ45 port PoE switch, port1-8 support IEEE 802.3af/at PoE international standard.
- total power is 250W.
- external power supply.

## PoE Switch Unmanaged 10/100/1000 M

Unmanaged PoE switch 6 Port, 65W / 110W.



### Features

- 4\*10/100/1000M PoE ports and 2\*10/100/1000M uplink RJ45 ports, Port 1-4 can support IEEE 802.3af/at PoE standard, external 65W/110W power supply .
- Support non-blocking wire speed forwarding.
- Support full duplex based on IEEE802.3x and half duplex based on backpressure.

Unmanaged PoE fiber switch 6 Port, 65W / 110W.



### Features

- 4\*10/100/1000M RJ45 ports and 2\*1000M uplink SFP fiber slot ports, port 1-4 can support IEEE 802.3af/at PoE standard, External 65W/110W power supply.
- Support non-blocking wire speed forwarding.
- Support full duplex based on IEEE802.3x and half duplex based on backpressure.

### Ordering Table

PRODUCT	PART NUMBER	DESCRIPTION	PRICE
PoE Switch 10/100 M	SW-UM-04PF-2FE	Unmanaged PoE switch with 4*10/100M PoE ports +2*10/100M uplink RJ45 ports.	1,800.00
	SW-UM-08PF-2FG	8*10/100M PoE port+2*10/100/1000M RJ45 port Unmanaged PoE switch, 110W, external power supply.	3,200.00
	SW-UM-08PF-2FG-250W	8*10/100M PoE port+2*10/100/1000M RJ45 port Unmanaged PoE switch, 250W, external power supply.	4,000.00
PoE Switch 10/100/1000 M	SW-UM-04PG-2GE	4*10/100/1000M PoE ports and 2*10/100/1000M uplink RJ45 ports, Port 1-4 can, external 65W power supply.	2,700.00
	SW-UM-04PG-2GE-110W	4*10/100/1000M PoE ports and 2*10/100/1000M uplink RJ45 ports, Port 1-4 can, external 110W power supply.	3,500.00
	SW-UM-04PG-2SFP	4*10/100/1000M RJ45 ports and 2*1000M uplink SFP fiber slot ports, port 1-4 can, External 65W power supply.	3,500.00
	SW-UM-04PG-2SFP-110W	4*10/100/1000M RJ45 ports and 2*1000M uplink SFP fiber slot ports, port 1-4 can, External 110W power supply.	4,200.00

## Unmanaged PoE power switch 10Port, 110W / 250W.



### Features

- 10\*10/100/1000M RJ45 port. Port 1-8 can support IEEE 802.3af/at PoE standard. external 110W/250W power supply.
- Support non-blocking wire speed forwarding.
- Support full duplex based on IEEE802.3x and half duplex based on backpressure.

## Unmanaged PoE fiber switch 10Port, 130W / 250W.



### Features

- 8\*10/100/1000M RJ45 ports and 2\*1000M uplink SFP fiber slot ports, port 1-8 can support IEEE 802.3af/at PoE standard, External 130W/250W power supply. Support 1U/19 inch rack installation.
- Support non-blocking wire speed forwarding.
- Support full duplex based on IEEE802.3x and half duplex based on backpressure.

## Unmanaged PoE power switch 18Port, 250W / 400W.



### Features

- 16 unmanaged 10/100 / 1000 M the RJ45 port +2 1000M SFP uplink optical port slots, the PoE power switch, 1- 16 port supports
- IEEE 802.3af / at PoE international standards
- the total power of the machine 250W/400W is, the Power supply
- support 1U / 19-inch cabinet installation .

## Unmanaged PoE fiber switch 24Port, 400W / 600W.



### Features

- 24\*10/100/1000M RJ45 ports and 2\*1000M uplink SFP fiber slot ports, port 1-24 can support IEEE 802.3af/at PoE standard, Built-in 400W/600W power supply. Support 1U/19 inch rack installation.
- Support full duplex based on IEEE802.3x and half duplex based on backpressure.

## Ordering Table

PRODUCT	PART NUMBER	DESCRIPTION	PRICE
POE Switch 10/100/1000 M	SW-UM-08PG-2GE	10*10/100/1000M RJ45 port. , external 110W power supply.	4,500.00
	SW-UM-08PG-2GE-250W	10*10/100/1000M RJ45 port. , external 250W power supply.	6,000.00
	SW-UM-08PG-2SFP	8*10/100/1000M RJ45 ports and 2*1000M uplink SFP fiber slot ports, External 130W power supply.	5,500.00
	SW-UM-08PG-2SFP-250W	8*10/100/1000M RJ45 ports and 2*1000M uplink SFP fiber slot ports, External 250W power supply.	7,000.00
	SW-UM-16PG-2SFP	16*10/100 / 1000 M the RJ45 port +2 1000M SFP uplink optical port slots, 250W the Power supply.	10,000.00
	SW-UM-16PG-2SFP-400W	16*10/100 / 1000 M the RJ45 port +2 1000M SFP uplink optical port slots, 400W the Power supply.	11,000.00
	SW-UM-24PG-2SFP	24*10/100/1000M RJ45 ports and 2*1000M uplink SFP fiber slot ports, Built-in 400W power supply	13,000.00
	SW-UM-24PG-2SFP-600W	24*10/100/1000M RJ45 ports and 2*1000M uplink SFP fiber slot ports, Built-in 600W power supply	15,500.00



## PoE Switch managed 10/100/1000 M

Layer two plus managed PoE fiber switch 10Port, 130W / 250W. **ICT Spec**



### Features

- 8\* 10/100/1000M RJ45 ports and 2\*100/1000M SFP fiber slot ports , Port 1-8 can support IEEE 802.3af/at PoE standard.
- Built-in 130W power supply. Support 1U/19 inch rack installation.

Layer two plus managed PoE fiber switch 18Port, 250W / 400W. **ICT Spec**



### Features

- 16\* 10/100/1000M RJ45 ports and 2\*100/1000M SFP fiber slot ports , Port 1-16 can support IEEE 802.3af/at PoE standard.
- Built-in 250W power supply. Support 1U/19 inch rack installation.

Layer two plus managed PoE fiber switch 28Port, 400W / 600W.



### Features

- 24\*10/100/1000M PoE ports and 2 set uplink (TP/SFP) ports. Port 1-24 can support IEEE 802.3af/at PoE standard,
- Built-in 400W power supply. Support 1U/19 inch cabinet installation.

## Fiber Optic Switch

8\*1000M SFP fiber port+2\*100/1000M RJ45 Switch.



### Features

- 2 Port 10/100/1000Mbps with Auto Uplink™ , 8 port 1000Mbps SFP Slot
- Automatic MAC address learning and aging
- 10/100/1000Mbps Auto-negotiation , auto-MDI-MDI-X

8\*1000M SFP fiber port+2\*100/1000M RJ45 Managed Switch.



### Features

- 2 Port 10/100/1000Mbps with Auto Uplink™ , 8 port 1000Mbps SFP Slot Managed
- Automatic MAC address learning and aging
- 10/100/1000Mbps Auto-negotiation , auto-MDI-MDI-X

16-ports 100M L2 Unmanaged Fiber Switch.



### Features

- Complies with IEEE802.3u standard
- Provides 16-port FE SFP fiber port
- Support Max packet length 1518 bytes

16-ports Full Gigabit L2 Unmanaged Fiber Switch.



### Features

- Complies with IEEE802.3ab/z standard
- Provides 16-port SFP fiber port and 1-port Console ports
- Supports VLAN function, Supports jumbo frame size 9K bytes

## Ordering Table

PRODUCT	PART NUMBER	DESCRIPTION	PRICE
POE Switch Managed 10/100/1000 M	SW-M-8G-2SFP	8* 10/100/1000M RJ45 ports and 2*100/1000M SFP fiber slot ports , Built-in 130W power supply.	10,500.00
	SW-M-8G-2SFP-250W	8* 10/100/1000M RJ45 ports and 2*100/1000M SFP fiber slot ports , Built-in 250W power supply.	12,000.00
	SW-M-16G-2SFP	16* 10/100/1000M RJ45 ports and 2*100/1000M SFP fiber slot ports , Built-in 250W power supply.	21,000.00
	SW-M-16G-2SFP-400W	16* 10/100/1000M RJ45 ports and 2*100/1000M SFP fiber slot ports , Built-in 400W power supply.	22,000.00
	SW-M-24G-2GE-2SFP	24*10/100/1000M PoE ports and 2 set uplink (TP/SFP) ports , Built-in 400W power supply	22,000.00
	SW-M-24G-2GE-2SFP-600W	24*10/100/1000M PoE ports and 2 set uplink (TP/SFP) ports , Built-in 600W power supply	24,000.00
Fiber Optic Switch	SW-FG-08SFP	8*1000M SFP fiber port+2*100/1000M RJ45 Switch	5,000.00
	SW-FGM-08SFP	8*1000M SFP fiber port+2*100/1000M RJ45 Managed Switch	7,000.00
	SW-FF-16SFP-L2	16-ports 100M L2 Unmanaged Fiber Switch	18,000.00
	SW-FG-16SFP-L2	16-ports Full Gigabit L2 Unmanaged Fiber Switch	22,000.00

## Unmanaged Industrial PoE+ Switch

4 port 10/100PoE+ 1x10/100M RJ45+ 1 SFP Uplink.



### Features

- Provide four 10/100Mbps ethernet ports and one uplink ethernet port and one uplink optical port (100Mbps)
- The PoE ethernet port supports IEEE802.3 af/at standard and can provides up to 30W power

8 port 10/100PoE+ 1x10/100/1000M RJ45 + 1 SFP Uplink.



### Features

- Provide eight 10/100Mbps ethernet ports and one uplink ethernet port and one uplink optical port (1000Mbps)
- The PoE ethernet port supports IEEE802.3 af/at standard and can provides up to 30W power

4 Ports Gigabit Ethernet HPoE Switch, 2SFP Uplink, 2 RJ45 Uplink.



### Features

- Standard: IEEE802.3 ,IEEE802.3u,IEEE802.3ab,IEEE802.3z,IEEE802.3 af/at;
- Provide 2 optical and 2 Ethernet uplink ports, wherein 1 optical port and 1 Ethernet port are Combo ports;
- Provide 4x10/100/1000 Mbps adaptive downlink ports, 1~4 ports of PoE switch support IEEE802.3af/at;

## Unmanaged Industrial Switch

Industrial 4 ports 100Mbps Ethernet Switch.



### Features

- Provide four10/100Mbps ethernet ports and one uplink ethernet port and one uplink optical port(100Mbps) ; and uplink optical port reserves SFP port for users to select SFP fiber modules of different performance to solve long distance transmission issue.

Industrial 8 ports 100Mbps Ethernet ports.



### Features

- Support IEEE802.3,IEEE802.3u, IEEE802.3ab, IEEE802.3z ;
- Provide 1\* uplink fiber port and Ethernet port, 8\* downlink Ethernet ports;
- 8K MAC address, easy for network system expansion;
- Support IEEE802.3X full duplex data control; support port (Auto MDI/MDIX) function

Industrial 4 ports Gigabit Ethernet Switch.



### Features

- Standard: IEEE802.3 ,IEEE802.3u,IEEE802.3ab,IEEE802.3z
- Provide 2 optical and 2 Ethernet uplink ports, wherein 1 optical port and 1 Ethernet port are Combo ports;
- Provide 4x10/100/1000 Mbps adaptive downlink ports, 1~4 ports of PoE switch support IEEE802.3af/at;

## Ordering Table

PRODUCT	PART NUMBER	DESCRIPTION	PRICE
Unmanaged Industrial PoE+ Switch	IPS-3104F1F1SF	Industrial Ethernet 4 port 10/100PoE+ 1x10/100M RJ45+ 1 SFP(10/100 M) uplink.	5,000.00
	IPS-3108F1G1SG	Industrial Ethernet 8 port 10/100PoE+ 1x10/100/1000M RJ45 + 1 SFP(10/100/1000M) uplink.	9,000.00
	IPS-3104G2G2S	Industrial 4 Ports Gigabit Ethernet HPoE Switch, 2SFP Uplink, 2 RJ45 Uplink.	7,500.00
Unmanaged Industrial Switch	INS-3104F1F1SF	Industrial 4 ports 100Mbps Ethernet Switch, uplink 1 Ethernet & 1 SFP Uplink port.	3,500.00
	INS-3108F1G1SG	Industrial 8 ports 100Mbps Ethernet ports, uplink Gigabit 1 Ethernet & 1 SFP.	6,000.00
	INS-3104G2G2S	Industrial 4 ports Gigabit Ethernet Switch, uplink 2 Ethernet & 2 SFP (combo).	5,000.00

บริษัท โฟค้อม (ประเทศไทย) จำกัด

12 ซอยสุขาภิบาล 5 ซอย 5 แยก 3 แขวงท่าแร้ง เขตบางเขน กรุงเทพฯ 10220 โทร. 063-391-5262 โทร. 02-557-6451 แฟกซ์. 02-557-6452

www.focomm-cabling.com

## Gigabit Industrial Ethernet Fiber Switch /Media Converter



### Features

- Industrial 4 Port 10/100/1000M
- Industrial design, 2x 10/100/1000M Ethernet RJ45 ports with Auto Uplink™ and 2 gigabit SFP slots
- RJ-45 port supports Auto MDI/MDI-X

## Managed Industrial POE Switch

Industrial 4 ports L2 Managed Gigabit High PoE switch.



### Features

- Provide 4\* 10/100/1000Base-T RJ45 ports(PoE), 2 \* 1000BASE-X SFP ports
- Buffer reaches 4Mbit, Support 4K high-definition video transmission
- PoE function: 1 port 60W HPoE, 3 ports 30W PoE
- Support one-key Fast-Ring setup, 2 SFP ports developed a fast-ring.
- Support relay alarm for power off, network broken, PoE off
- 6KV surge immunity, 8KV ESD protection and antiinterference ability

Industrial 8 ports L2 Managed Gigabit PoE switch.



### Features

- Provide 8\* 10/100/1000Base-T RJ45 ports(PoE), 4 \* 1000BASE-X SFP ports
- Buffer reaches 4Mbit, Support 4K high-definition video transmission
- PoE function: 1 port 60W HPoE, 3 ports 30W PoE
- Support one-key Fast-Ring setup, 2 SFP ports developed a fast-ring.
- Support relay alarm for power off, network broken, PoE off
- 6KV surge immunity, 8KV ESD protection and antiinterference ability.

## Managed Industrial Switch

4 ports Gigabit layer 2 Ethernet Switch, Uplink 2 SFP.



### Features

- Broadcom chip; Buffer reaches 4Mbit, Support 4K high-definition video transmission;
- PoE function: Fully support IEEE802.3 af/at standard, T1 60W max. T2~T4 30W max.
- Support Web-based network management, support VLAN, QoS, Fast-Ring, RSTP, SNMP etc. network function

8 ports Gigabit layer 2 Ethernet Switch, Uplink 4 SFP.



### Features

- Provide 8\* 10/100/1000Base-T RJ45 ports, 4 \* 1000BASE-X SFP ports
- Buffer reaches 4Mbit, Support 4K high-definition video transmission;
- Support Web-based network management, support VLAN, QoS, RSTP, SNMP etc. network function
- 6KV surge immunity

## Ordering Table

PRODUCT	PART NUMBER	DESCRIPTION	PRICE
Gigabit Industrial Ethernet Fiber Switch	INS-33042G	Industrial 4 Port 10/100/1000M	4,000.00
Managed Industrial PoE Switch	IPMS-3104G2S	Industrial 4 ports L2 Managed Gigabit High PoE switch, 4PoE +2fiber, all ports Gigabit	10,000.00
	IPMS-3108G4S	Industrial 8 ports L2 Managed Gigabit PoE switch, 8PoE + 4 fiber, all ports 1000Mbps	14,000.00
Managed Industrial Switch	IMS-3104G2G2S	Industrial 4 ports Gigabit layer 2 Ethernet Switch, Uplink 2 SFP	8,500.00
	IMS-3108G2G4S	Industrial 8 ports Gigabit layer 2 Ethernet Switch, Uplink 4 SFP	11,000.00

## PoE Injector/PoE Splitter

10/100M PoE injector, 2x 10/100M RJ45 ports.



### Features

- 2x copper cable RJ45 ports, 1x AC input port
- mid-span: 4/5, 7/8 data line pair(default); end-span: 1/2,3/6 spare line pair (can be customized)
- 100BASE-TX: 5Cat and more UTP ( $\leq 100$  meters)

10/100/1000M PoE injector, 2x 10/100M RJ45 ports.



### Features

- 10/100/1000M copper cable RJ45 PoE port, 1x AC input port
- end-span: 1/2,3/6 spare line pair (default); mid-span: 4/5, 7/8 data line pair(can be customized)
- 1000BASE-TX: 5Cat and more UTP ( $\leq 100$  meters)

10/100M PoE Splitter Cable, 24W.



### Features

- 1/2(+),3/6(-);4/5(+),7/8(-) power supply
- 1x 10/100Mbps RJ45 input port, 1\*10/100M male output port, 1\*(5.5\*2.1mm) DC output port
- Cat5 (UTP) or more

10/100M, 24W, 2x RJ45 ports.



### Features

- Dual output, 5V/ 12V DC output, can be adjustable
- Compatible with IEEE 802.3at PSE devices
- Support 10/100M data transmission through RJ45

10/100/1000M, 24W, 2x RJ45 ports.



### Features

- Dual output, 5V/ 12V DC output, can be adjustable
- Compatible with IEEE 802.3at PSE devices
- Support 10/100/1000M data transmission through RJ45

10/100M, 2x RJ45 ports, 1x PoE Port.



### Features

- Single PoE port output power is 60W max.
- Input voltage: 56V; Output: DC12V/24V
- 2x 10/100 Mbps RJ45 ports,  
1x high power PoE port

10/100/1000M, 2x RJ45 ports.



### Features

- Single PoE port output power is 60W max.
- Input voltage: 56V; Output: DC12V/24V
- 2x 10/100 Mbps RJ45 ports,  
1x high power PoE port

## Ordering Table

PRODUCT	PART NUMBER	DESCRIPTION	PRICE
PoE Injector/PoE Splitter	SW-POEIJ-02F-60	10/100M PoE injector, 2x 10/100M RJ45 ports; 1x AC input port,PoE port power is 60W.Total power is 65W.	1100.00
	SW-POEIJ-02G-60	10/100/1000M PoE injector, 2x 10/100M RJ45 ports; 1x AC input port,PoE port power is 60W.Total power is 65W.	1200.00
	SW-POEST-FC-24	10/100M PoE Splitter Cable, 24W	450.00
	SW-POEST-F-24	10/100M; IEEE802.3at, 24W, 2x RJ45 ports, 1x DC port; 5V/ 12V DC output	800.00
	SW-POEST-G-24	10/100/1000M; IEEE802.3at, 24W, 2x RJ45 ports, 1x DC port; 5V/ 12V DC output	1100.00
	SW-POEST-F-60	10/100M, 2x RJ45 ports, 1x PoE Port, single PoE port power is 60W.	1200.00
	SW-POEST-G-60	10/100/1000M, 2x RJ45 ports, 1x PoE Port, single PoE port power is 60W.	Call



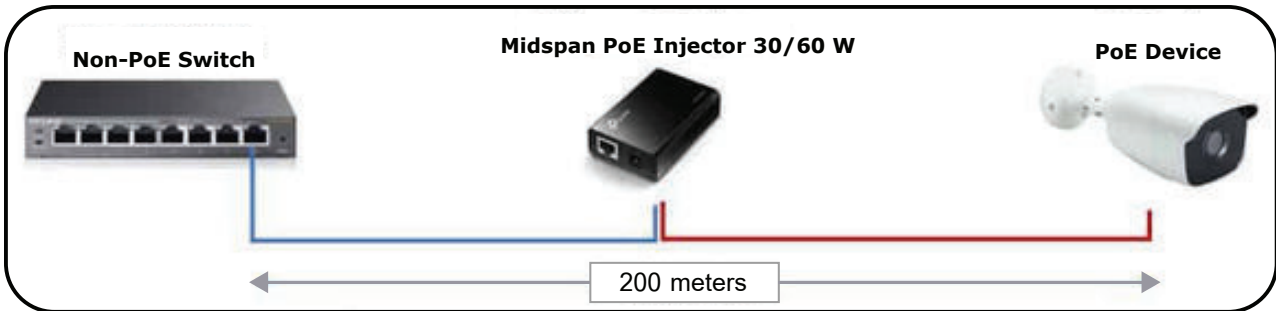

### Product Focomm

- สายทองแดง 10/100 / 1000M พอร์ต RJ45 PoE, พอร์ตอินพุต AC 1x
- สิ้นสุดช่วง: 1 / 2,3 / 6 คู่สายอะไหล่ (ค่าเริ่มต้น); ช่วงกลาง: 4/5, 7/8 คู่สายข้อมูล (สามารถกำหนดเองได้)
- 1000BASE-TX: 5 Uat และอื่น ๆ (≤100เมตร)

Support fast ring with self-healing in 20ms Min. The network is more stable and reliable

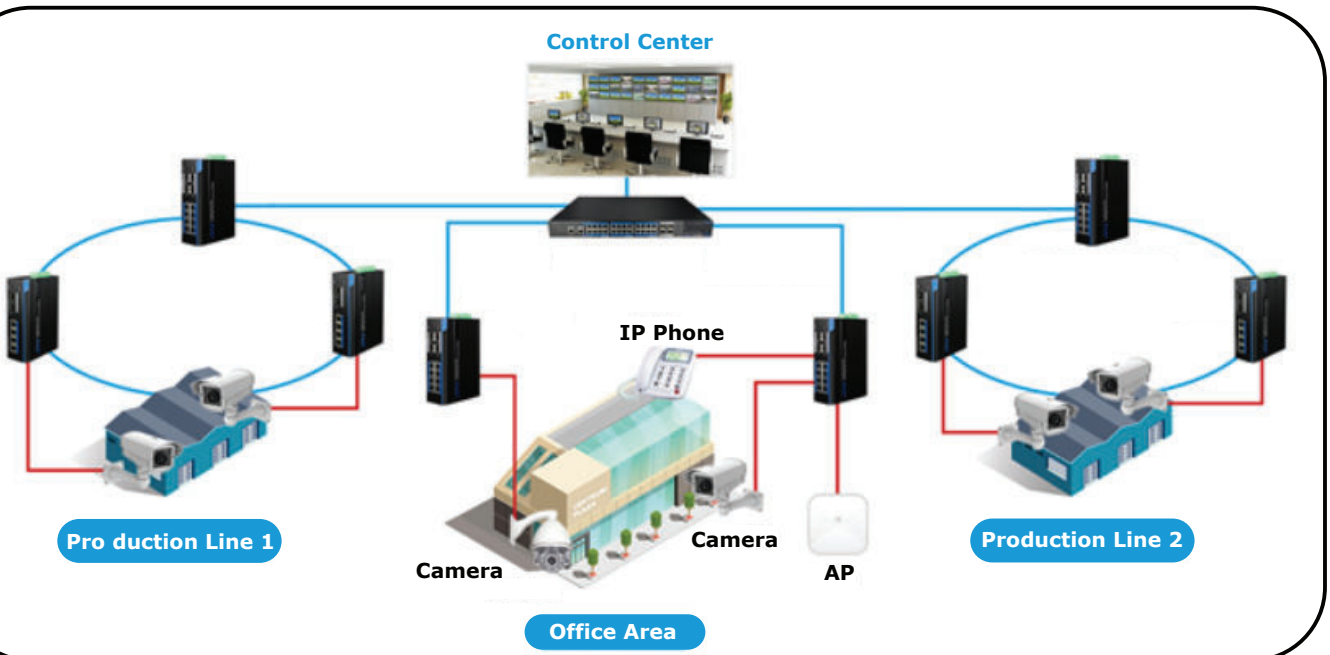



# Surge Protection Product

- AC Surge, DC Surge
- POE surge protection
- CCTV Surge Protection
- RJ11 Surge Protector

## AC D Class Power Surge Protector



SP-PD20-275/2

### PROPERTIES

- Uc: 50/60Hz 275V
- In: 10kA
- Imax: 20kA
- Up: 1200V
- Protection mode: L/N-PE



SP-PD20-275/4

### PROPERTIES

- Uc: 50/60Hz 275V
- In: 10kA
- Imax: 20kA
- Up: 1200V
- Protection mode: L1/L2/L3/N-PE

## AC C Class Power Surge Protector



SP-PC40-385/2

### PROPERTIES

- Uc: 50/60Hz 385V
- In: 20kA
- Imax: 40kA
- Up: 1700V
- Protection mode: L/N-PE



SP-PC40-385/4

### PROPERTIES

- Uc: 50/60Hz 385V
- In: 20kA
- Imax: 40kA
- Up: 1700V
- Protection mode: L1/L2/L3/N-PE

## AC B Class Power Surge Protector



SP-PB100-385/2

### PROPERTIES

- Uc: 50/60Hz 385V
- In: 50kA
- Imax: 100kA
- Up: 2800V
- Protection mode: L/N-PE



SP-PB100-385/4

### PROPERTIES

- Uc: 50/60Hz 385V
- In: 50kA
- Imax: 100kA
- Up: 2800V
- Protection mode: L1/L2/L3/N-PE

## DC power surge protector



SP-PC40-85DC

### PROPERTIES

- Uc: 85VDC
- In: 15kA
- Imax 40kA
- Up: 500V
- Protection mode: +/-PE



SP-PC40-600DC

### PROPERTIES

- Uc: 600VDC
- In: 20kA
- Imax 40kA
- Up: 1800V
- Protection mode: +/-PE



SP-PC40-1000DC

### PROPERTIES

- Uc: 1000VDC
- In: 20kA
- Imax 40kA
- Up: 3500V
- Protection mode: +/-PE



SP-PD20-48/DC

### PROPERTIES

- Uc: 48VDC
- In: 10kA
- Imax 20kA
- Up: 400V
- Protection mode: +/-PE



SP-PD10-275DC

### PROPERTIES

- Uc: 275VDC
- In: 5kA
- Imax 10kA
- Up: 400V
- Protection mode: +/-PE

## Ordering Table

PRODUCT	PART NUMBER	DESCRIPTION	PRICE
AC D Class( Single Phase )	SP-PD20-275/2	50/60Hz 275V In: 10kA Imax: 20kA Up: 1200V Protection mode: L/N-PE	1,200.00
( Three Phase )	SP-PD20-275/4	50/60Hz 275V In: 10kA Imax: 20kA Up: 1200V Protection mode: L1/L2/L3/N-PE	2,500.00
AC C Class( Single Phase )	SP-PC40-385/2	50/60Hz 385V In: 20kA Imax: 40kA Up: 1700V Protection mode: L/N-PE	1,500.00
( Three Phase )	SP-PC40-385/4	50/60Hz 385V In: 20kA Imax: 40kA Up: 1700V Protection mode: L1/L2/L3/N-PE	3,000.00
AC B Class( Single Phase )	SP-PB100-385/2	50/60Hz 385V In: 50kA Imax: 100kA Up: 2800V Protection mode: L/N-PE	5,500.00
( Three Phase )	SP-PB100-385/4	50/60Hz 385V In: 50kA Imax: 100kA Up: 2800V Protection mode: L1/L2/L3/N-PE	10,000.00
DC power surge protector	SP-PC40-85DC	85VDC In: 15kA Imax 40kA Up: 500V Protection mode: +/-PE	1,400.00
	SP-PC40-600DC	600VDC In: 20kA Imax 40kA Up: 1800V Protection mode: +/-PE	1,400.00
	SP-PC40-1000DC	1000VDC In: 20kA Imax 40kA Up: 3500V Protection mode: +/-PE	2,000.00
	SP-PD20-48/DC	48VDC In: 10kA Imax 20kA Up: 400V Protection mode: +/-PE	1,200.00
	SP-PD10-275DC	275VDC In: 5kA Imax 10kA Up: 400V Protection mode: +/-PE	1,200.00

บริษัท โฟคคอมม์ (ประเทศไทย) จำกัด

12 ซอยสุขุมวิท 5 ซอย 5 แยก 3 แขวงท่าแร้ง เขตบางเขน กรุงเทพฯ 10220 โทร. 063-391-5262 โทร. 02-557-6451 แฟกซ์. 02-557-6452

www.focomm-cabling.com

## Coaxial Video surge protectors



SP-SV-BNC

- PROPERTIES**
- BNC Connector
  - Uc: 12V
  - I<sub>max</sub>: 5kA

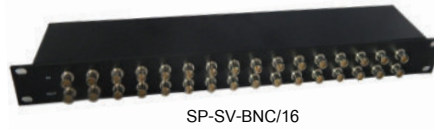

SP-SV-BNC/16

- PROPERTIES**
- BNC Connector
  - Uc: 12V
  - I<sub>max</sub>: 5kA

## Camera surge protectors



SP-SN-2

- PROPERTIES**
- 100Mbps
  - Network and power lines 2 in 1 protection
  - I<sub>max</sub>: 10kA
  - Uc: 12/24/220 V



SP-SHN-2

- PROPERTIES**
- 1000Mbps
  - Network and power lines 2 in 1 protection
  - I<sub>max</sub>: 10kA
  - Uc: 12/24/220 V

## HD-SDI Surge Protection



SV-SDI

- PROPERTIES**
- SDI Connector
  - Uc: 12V
  - I<sub>max</sub>: 5kA
  - 1.485Gbps



SP-OP-SV2/SDI

- PROPERTIES**
- HD-SDI video and power lines 2 in 1 protection
  - Uc: Power 275V
  - Signal 12V 1.485Gbps



SP-OP-SV3/SDI

- PROPERTIES**
- HD-SDI video, control, and power lines 3 in 1 protection
  - Uc: Power 275V
  - Signal 12V 1.485Gbps

## Ordering Table

PRODUCT	PART NUMBER	DESCRIPTION	PRICE
Coaxial Video surge protectors	SP-SV-BNC	BNC Connector Uc: 12V I <sub>max</sub> : 5kA	1,200.00
	SP-SV-BNC/16	16 Ports BNC Connector Uc: 12V I <sub>max</sub> : 5kA 19 in rack mont	16,000.00
Camera surge protectors	SP-SN-2	100Mbps Network and power lines 2 in 1 protection I <sub>max</sub> : 10kA Uc: 12/24/220 V	1,700.00
	SP-SHN-2	1000Mbps Network and power lines 2 in 1 protection I <sub>max</sub> : 10kA Uc: 12/24/220 V	2,000.00
HD-SDI Surge Protection	SP-SV-SDI	SDI Connector Uc: 12V I <sub>max</sub> : 5kA 1.485Gbps	2,400.00
	SP-OP-SV2/SDI	HD-SDI video and power lines 2 in 1 protection Uc: Power 275V Signal 12V 1.485Gbps	2,800.00
	SP-OP-SV3/SDI	HD-SDI video, control, and power lines 3 in 1 protection Uc: Power 275V Signal 12V 1.485Gbps	3,200.00



## Control line Surge Protector



SP-PUC-12

**PROPERTIES**

- V.1, X.27, RS485, RS422
- I<sub>max</sub>: 5kA
- 10Mbps 4 lines



SP-PUC-24-2

**PROPERTIES**

- V.1, X.27, RS485, RS422
- I<sub>max</sub>: 5kA
- 10Mbps



SP-PUC-48-2

**PROPERTIES**

- V.1, X.27, RS485, RS422
- I<sub>max</sub>: 5kA
- 10Mbps

## Signal/Data Line SPD



SP-SNH-RJ45

**PROPERTIES**

- CAT5, CAT5e, CAT6
- 1000Mbps RJ45
- U<sub>c</sub>: 5V
- I<sub>max</sub>: 5kA



SP-SNH-RJ45/24

**PROPERTIES**

- CAT5, CAT5e, CAT6
- 1000M RJ45 24ports
- U<sub>c</sub>: 5V
- I<sub>max</sub>: 5kA

## POE surge protection



SP-SNH-RJ45/POE

**PROPERTIES**

- CAT5e, CAT5, CAT6
- U<sub>c</sub>: 60V
- I<sub>max</sub>: 5kA
- Protection line 1/2,3/6
- 1000Mbps



SP-SNH-RJ45/POE/16

**PROPERTIES**

- U<sub>c</sub>: 60V I<sub>max</sub>: 10kA
- Protection line 1-8
- U<sub>c</sub>: 5V I<sub>max</sub>: 6kA
- Protection line 1-8
- 1000Mbps



SP-SNH-RJ45/POE-OD

**PROPERTIES**

- IP65 Waterproof
- U<sub>c</sub>: 60V
- I<sub>max</sub>: 5kA
- Protection line 1/2,3/6
- 100Mbps

## Ordering Table

PRODUCT	PART NUMBER	DESCRIPTION	PRICE
Control line Surge Protector	SP-PUC-12	V.1, X.27, RS485, RS422 I <sub>max</sub> : 5kA 10Mbps 4 lines	1,500.00
	SP-PUC-24-2	V.1, X.27, RS485, RS422 I <sub>max</sub> : 5kA 10Mbps 2 lines, DIN Rail	1,600.00
	SP-PUC-48-2	V.1, X.27, RS485, RS422 I <sub>max</sub> : 5kA 10Mbps 2 lines, hot-plugging	1,600.00
Signal/Data Line SPD	SP-SNH-RJ45	CAT5, CAT5e, CAT6 1000Mbps RJ45 U <sub>c</sub> : 5V I <sub>max</sub> : 5kA Protection line 1-8	1,600.00
	SP-SNH-RJ45/24	CAT5, CAT5e, CAT6 1000M RJ45 24ports U <sub>c</sub> : 5V I <sub>max</sub> : 5kA Protection line 1-8	28,000.00
POE Surge Protectors	SP-SNH-RJ45/POE	CAT5e, CAT6 U <sub>c</sub> : 60V I <sub>max</sub> : 5kA Protection line 1/2,3/6 1000Mbps	1,800.00
	SP-SNH-RJ45/POE/16	16 ports CAT5e and CAT5 CAT6 Power Parameter: U <sub>c</sub> : 60V I <sub>max</sub> : 10kA Protection line 1-8 Ethernet Parameter: U <sub>c</sub> : 5V I <sub>max</sub> : 6kA Protection line 1-8 1000Mbps	24,000.00
	SP-SNH-RJ45/POE-OD	IP65 Waterproof CAT5E, CAT6 U <sub>c</sub> : 60V I <sub>max</sub> : 5kA Protection line 1/2,3/6 1000Mbps	2,500.00

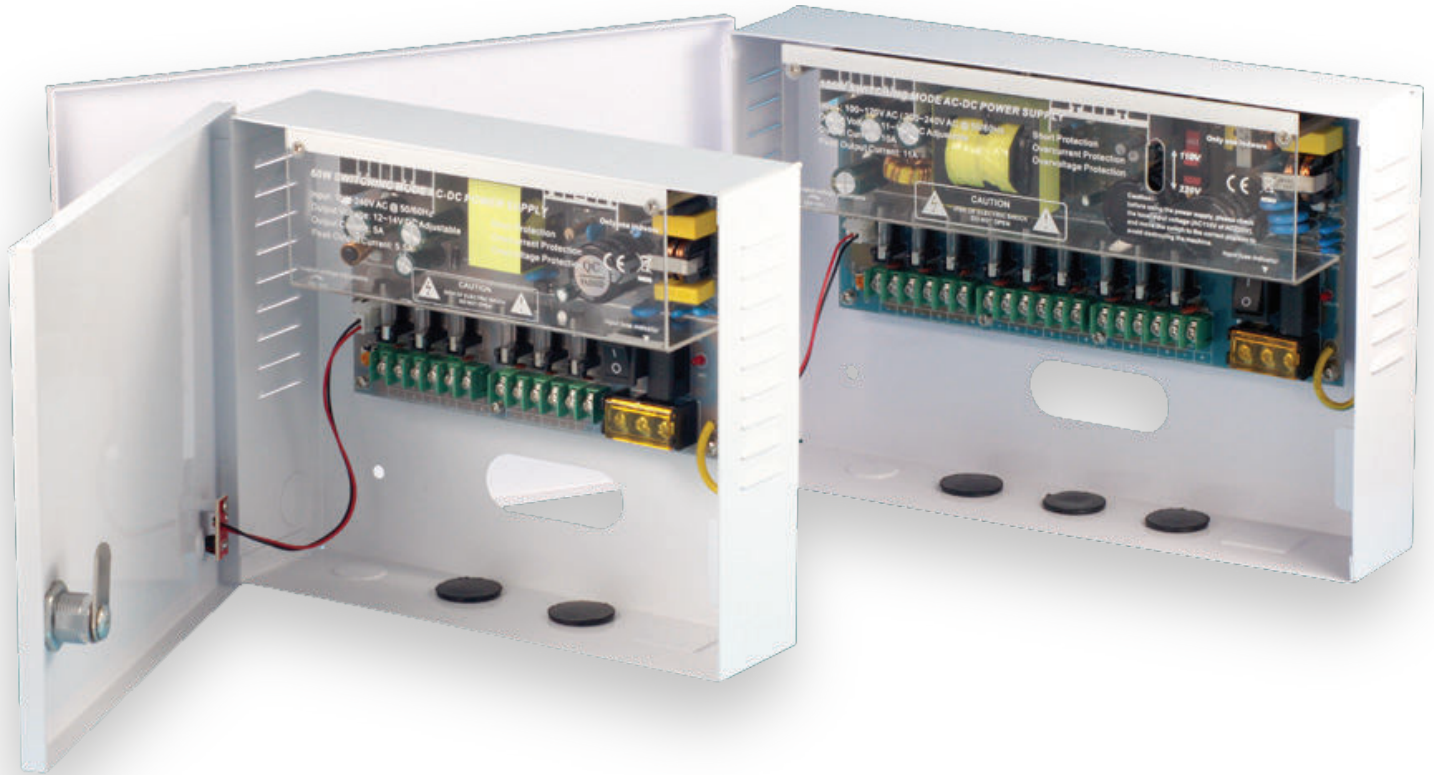

# Power Supply Product

- Switching Power Supply
- Power Supply For CCTV
- Power Supply For Access Control
- Power Supply DIN Rail



## Switching Power Supply



Switching Power Supply 12V, 3A

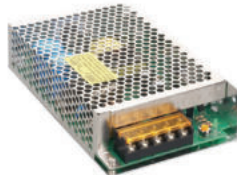

Switching Power Supply 12V, 5A

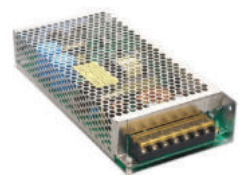

Switching Power Supply 12V, 8.5A

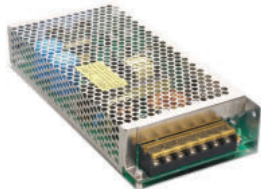

Switching Power Supply 12V, 10A



Switching Power Supply 12V, 12.5A

### Feature

Enclosed type series, for indoor use only, can apply on CCTV system, indoor lighting application, medical equipments, are most widely used series for indoor applications.

## Power Supply For CCTV

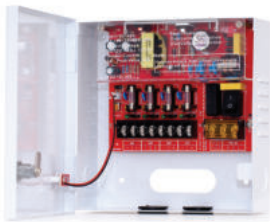

12Vdc 3Amp 4Way CCTV power supply



12Vdc 10Amp 08Way CCTV power supply



12Vdc 12Amp 16Way CCTV power supply

### Feature

- Metal cabinet with key lock
- Individual LED indicators and fuse for each output
- Triple electronic protection
- Adjustable output voltage
- Product description: Applicable to CCTV camera, photoelectric beam detector etc.

### Ordering Table

PRODUCT	PART NUMBER	DESCRIPTION	PRICE
Switching Power Supply	P-SW-12V-3A	Switching Power Supply 12V, 3A	300.00
	P-SW-12V-5A	Switching Power Supply 12V, 5A	400.00
	P-SW-12V-8.5A	Switching Power Supply 12V, 8.5A	550.00
	P-SW-12V-10A	Switching Power Supply 12V, 10A	600.00
	P-SW-12V-12.5A	Switching Power Supply 12V, 12.5A	650.00
Power Supply For CCTV	P-CCTV-04CH	Metal cabinet with key lock, 12Vdc 3Amp 4Way CCTV power supply	1,200.00
	P-CCTV-08CH	Metal cabinet with key lock, 12Vdc 10Amp 08Way CCTV power supply	1,500.00
	P-CCTV-16CH	Metal cabinet with key lock, 12Vdc 12Amp 16Way CCTV power supply	2,200.00

## Power Supply For Access Control

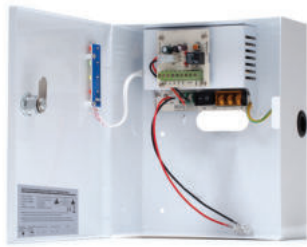

Metal cabinet with key lock, 12Vdc 3Amp access control ups



Metal cabinet with key lock, 12Vdc 5Amp access control ups

### Feature

- Metal cabinet with key lock
- High level/Low level/On-Off three control methods
- Active NC/NO two ways, suitable for all types of electric locks
- Delay lock adjustable from 0 to 10 seconds
- Product description: Applicable to all types of Access control systems

## Power Supply DIN Rail



Power Supply, DIN Rail 45W, 24V, 2A



Power Supply, DIN Rail 60W, 24V, 2.5A



Power Supply, DIN Rail 75W, 24V, 3.2A / 48V, 1.6A



Power Supply, DIN Rail 120W, 24V, 5A / 48V, 2.5A

### Feature

- Small volume,high efficiency
- Protection:over voltage/over load/short circuit
- 100% full load burn-in test
- Can be mounted on the DIN rail
- Most widely used for industrial area

### Ordering Table

PRODUCT	PART NUMBER	DESCRIPTION	PRICE
Power Supply For Access Control	P-SW-AC-12V-3A	Metal cabinet with key lock, 12Vdc 3Amp access control ups	1,200.00
	P-SW-AC-12V-5A	Metal cabinet with key lock, 12Vdc 5Amp access control ups	1,500.00
	P-SW-AC-12V-10A	Metal cabinet with key lock, 12Vdc 10Amp access control ups	2,000.00
Power Supply DIN Rail	P-DR-45-24	Power Supply, DIN Rail 45W, 24V, 2A	1,500.00
	P-DR-60-24	Power Supply, DIN Rail 60W, 24V, 2.5A	1,700.00
	P-DR-75-24	Power Supply, DIN Rail 75W, 24V, 3.2A	1,800.00
	P-DR-75-48	Power Supply, DIN Rail 75W, 48V, 1.6A	1,800.00
	P-DR-120-24	Power Supply, DIN Rail 120W, 24V, 5A	2,000.00
	P-DR-120-48	Power Supply, DIN Rail 120W, 48V, 2.5A	2,000.00



## Power Supply

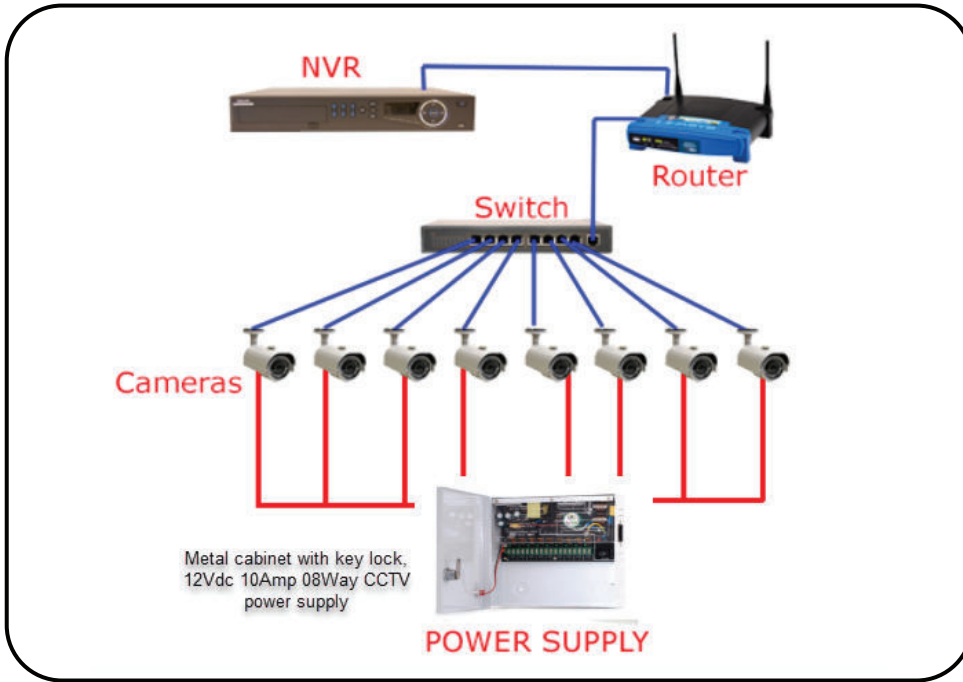

**Power Supply For CCTV**

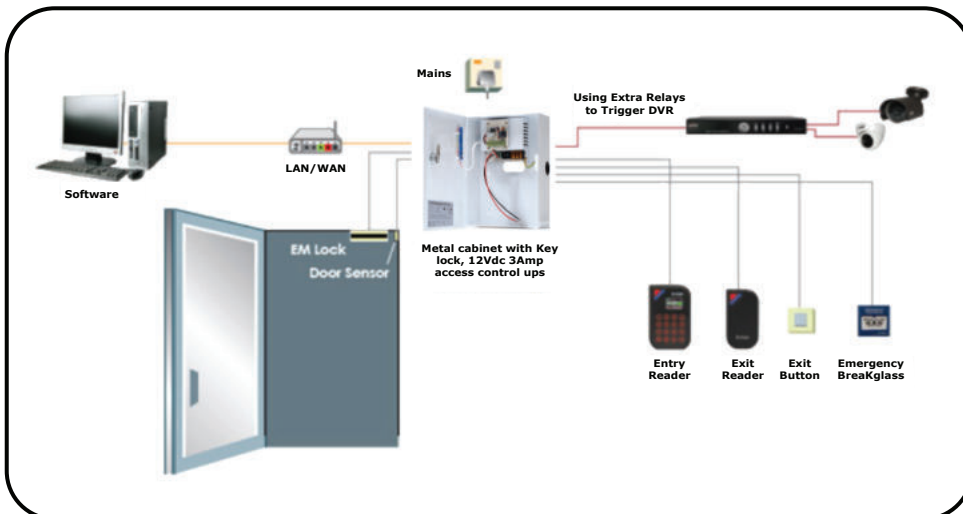

**Power Supply For Access Control**

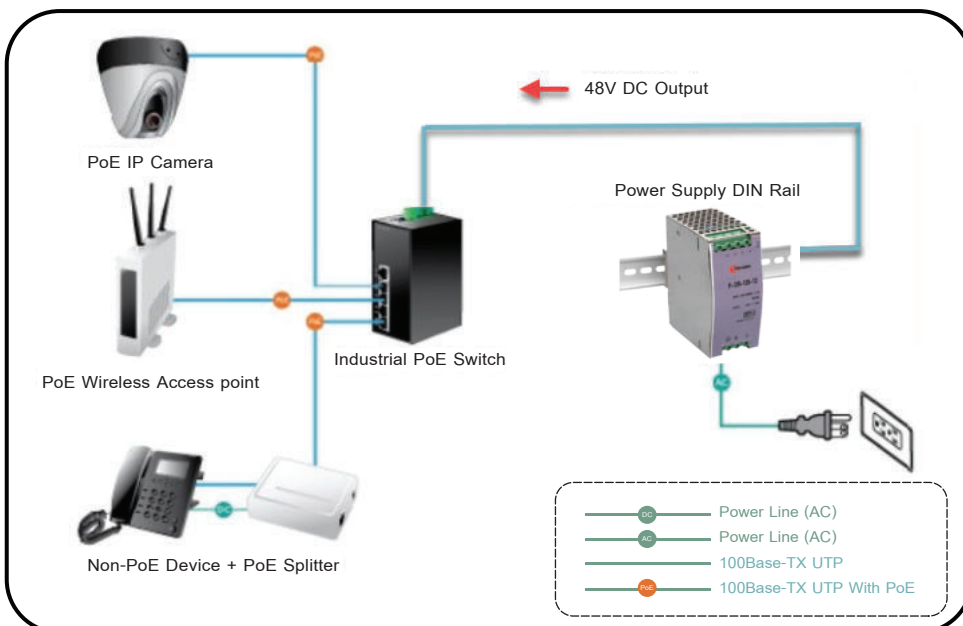

**Power Supply DIN Rail**



# Fiber Tool and Tester

- Focomm**
  - UTP Tool
  - RG Cable Tool
  - Networking and CCTV Tester
- T3 Innovation**
  - UTP Tool
  - Networking Tester
- Noyafa**
  - Net Tester
  - Networking and CCTV Tester
- Focomm**
  - Fiber Optic Tool
  - Fiber Optic Tester



## UTP Tool



Easy Crimping Hand Tool



Speed Termination Tool



Crimping Tool 4P,6P,8P with Ratchet



Impact Tool



Network Tool Kit

## RG Cable Tool



Coaxial Crimping Tool (RG59,6,11,213)



Cable Stripper (RG59,6,11,213,UTP)

## Networking and CCTV Tester

### Multi Function tester



#### Features

- 8 inch retina touch screen, 2048\*1536 resolution
- 8MP CVI/ TVI/ AHD, 8MP EX-SDI, HD-SDI, 3G-SDI\*
- H.265/H.264, 4K video display via mainstream
- Chrome browser, test and set Axis camera
- Anti-sunlight and screen protecting cover
- HDMI input support 1080P
- HDMI output support 4K
- DC12V 3A, DC 48V PoE power output

### CCTV Tester



#### Features

- 8MP CVI/ TVI/ AHD, 8MP EX-SDI, HD-SDI, 3G-SDI\*
- H.265/H.264, 4K video display via mainstream
- Dahua, Hikvision, Axis etc Camera test
- Rapid, auto view video and create testing report
- Dc12V 3A, DC48V PoE power output
- Built in WIFI, create WIFI hotspot
- 10/100/100M Ethernet, network state and traffic display

### Ordering Table

PRODUCT	PART NUMBER	DESCRIPTION	PRICE
UTP Tool	TT-EZT-RJ45/RJ11	Crimping Hand Tool For Easy RJ45 and RJ11	2,000.00
	TT-EZT-KJ-180	Speed Termination Tool for 180 Degree Keystone Jack	1,800.00
	TT-RJ45/RJ11	Crimping Tool 4P,6P,8P with Ratchet	600.00
	TT-IT	Impact Tool	450.00
	TT-TK-01	Network Tool Kit	2,000.00
RG Cable Tool	TT-CCT	Coaxial Crimping Tool ( RG59,6,11,213 )	650.00
	TT-CS	Cable Stripper (RG59,6,11,213,UTP)	650.00
Networking and CCTV Tester	TT-MFT-X9	Multi Function tester (POE/HDMI/Network/CCTV/IP Scan/ONVIP/4K)	25,000.00
	TT-IPAHD	CCTV Tester, AHD Camera & IP camera testing.	9,000.00

# Tool and Tester Product



## UTP Tool Innovation



Snap Plug™ Heavy Duty Crimp Tool



Heavy Duty RJ Crimper



Coaxial Cable Stripper



Network Cable Strip & Cut



Multiple Cable Strip&Cut



10 Gig RJ Crimping Tool

## UTP Tester Innovation

### Net Chaser™ Ethernet Speed Certifier (Support IPv4 and IPv6)



#### Features

- Net Chaser main unit
- Network Patch Cable\*2
- Sacrificial Cable\*2
- Micro USB Cable
- Carabiner Strap
- 4GB SD Card
- Active Remote

### T3innovation Giga test



#### Features

- Wireless reporting of results to mobile devices or laptops
- One ended Cable Test: Detects wiring issues or bad connections per TIA568 A/B
- Linked Speed Indication: Green/Red LEDs showing speed link rate at each level, IEEE 802-3

### Net Prowler™ Cabling and Advanced Network test smat remote 1



#### Features

- Net Prowler™ Main Unit
- F-Connector Coupler: F81
- Cable Assembly: micro USB to USB
- Cable Assembly: RJ12, 1-1 pinned, 8 inch \*2PC
- Network and Telephone Testing/ID Remote: #1
- T3 Small black pouch

### Net Prowler™ Cabling and Advanced Network test smat remote 1-8



#### Features

- Net Prowler™ Main Unit
- F-Connector Coupler: F81
- Cable Assembly: micro USB to USB
- Cable Assembly: RJ12, 1-1 pinned, 8 inch \*2PC
- Coax ID Remote Set: #1-20 coax ID includes foam holder

## Ordering Table

PRODUCT	PART NUMBER	DESCRIPTION	PRICE
UTP Tool ( T3innovation )	T10520	SNAP PLUG™ HEAVY DUTY CRIMP TOOL	2,000.00
	T10420	Heavy Duty RJ Crimper	1,100.00
	T304106	Coaxial Cable Stripper	250.00
	T30210	Network Cable Strip & Cut	370.00
	T30110	Multiple Cable Strip&Cut	480.00
	T10310	10 Gig RJ Crimping Tool	1,000.00
UTP Tester ( T3innovation )	TNC950AR	Net Chaser™ Ethernet Speed Certifier (Support IPv4 and IPv6)	80,000.00
	GT1005	T3innovation Giga test	50,000.00
	TNP700	Net Prowler™ Cabling and Advanced Network test smat remote 1	30,000.00
	TNP800	Net Prowler™ Cabling and Advanced Network test smat remote 1-8	35,000.00

บริษัท โฟคอมม (ประเทศไทย) จำกัด

12 ซอยสุขุมวิท 5 ซอย 5 แยก 3 แขวงท่าแร้ง เขตบางเขน กรุงเทพฯ 10220 โทร. 063-391-5262 โทร. 02-557-6451 แฟกซ์. 02-557-6452

www.focomm-cabling.com



# Tool and Tester Product

## Networking and CCTV Tester



### Cable length tester to measure length



#### Features

- TDR theory to measure length of cat5e, cat6 and cat7 cable, coaxil cable, telephone cable.
- Wiremapping with length and provide the distance to fault information.

### Cable length tester to measure length



#### Features

- PoE / PING testing.
- Trace targeted cable among lots of unknown
- Locate faults for RJ11/RJ45/BNC Cable
- measure cable length accurately
- Voltage detecting function.

### Wire Tracker, UTP/STP RJ45, RJ11 and metal cable



#### Features

- Check and find the needed cables among so many cables in one time.
- Continuity test — wiremap for Lan cables.
- Diagnose the breakage, open, short, cross.
- Visible indication: pin-to-pin cable map for individual cable (not by pairs).

### HDMI Cable Tester



#### Features

- Fast and accurate verification with type A - A, A - C and C - C connectors.
- Check miswires, short, open and cross status of HDMI cables.
- Mapping continuity and proper configuration.

### 4 in 1 Cable Tester, Tests 4 types of cables: RJ11/ RJ45/ USB/ BNC.



#### Features

- Tests 4 types of cables: RJ11/ RJ45/ USB/ BNC.
- Test distance: 1500Ft
- LEDs indicate connections and faults.
- Simple one-button test.
- Detachable module for testing remote points.

### Network Cable Tester



#### Features

- Visible LED status display.
- Check the RJ11& RJ45 Cable quickly.
- Endurable and prevent of burnout.
- Flashlight helps work in dark.
- Slow and fast test switch.

### POE Tester



#### Features

- Test the information of the standard PoE device, such as a/at standard, power supply voltage, power supply polarity, and crossover mode.
- Identify the supply voltage, power supply polarity, and crossover mode of non-standard PoE devices.
- Check the short circuit, crossover and open circuit status in the network cable with the far end.
- Test the power consumed by DC appliances.
- The loop-back test function of the switch.

### Ordering Table

PRODUCT	PART NUMBER	DESCRIPTION	PRICE
Networking and CCTV Tester	NF-8601S	cat5e, cat6 and cat7 cable, coaxil cable, telephone cable.	8,000.00
	NF-8601W	cat5e, cat6 and cat7 cable, coaxil cable, telephone cable, POE / Ping testing	7,800.00
	NF-806	Wire Tracker, UTP/STP RJ45, RJ11 and metal cable	1,800.00
	NF-622	HDMI Cable Tester	1,500.00
	NF-3368	4 in 1 Cable Tester, Tests 4 types of cables: RJ11/ RJ45/ USB/ BNC.	800.00
	NF-468PF	Network Cable Tester	800.00
	NF-468PT	POE Tester	1,200.00

บริษัท โฟคอมม (ประเทศไทย) จำกัด

12 ซอยสุขาภิบาล 5 ซอย 5 แยก 3 แขวงท่าแร้ง เขตบางเขน กรุงเทพฯ 10220 โทร. 063-391-5262 โทร. 02-557-6451 แฟกซ์. 02-557-6452

www.focomm-cabling.com

# Tool and Tester Product



## Tool



## Ordering Table

PRODUCT	PART NUMBER	DESCRIPTION	PRICE
Tool	TT-FS	Three Hole Fiber Stripper	650.00
	TT-KC	cutting kevlar of Fiber optical Cable	400.00
	TT-FTTH-S	Strip FTTH Fiber optical Cable	450.00
	TT-OJC	Outer Jacket Cutter for Fiber Optic Cable	1,400.00
	TT-LTC	Loose Tube Cutter for Fiber Optic Cable	700.00
	TT-IC	Indoor Cutter for Fiber Optic Cable	420.00
	TT-CFC	Cleaner for fiber Optic connector	1,500.00
	TT-CP	Fiber Cleaning Paper (100 pc/Pack )	300.00
	TT-C-SCFCST	One Click Cleaner (SC/FC/ST) (100 pc/Pack )	1,000.00
	TT-C-LCMU	One Click Cleaner (LC/MU) (100 pc/Pack )	1,000.00
	TT-C-MPO	One Click MPO Cleaner	1,800.00
	TT-VFL-01MW	Visual Fault Locator 1mw Output (Testing Distance : 3-5KM)	700.00
	TT-VFL-10MW	Visual Fault Locator 10mw Output (Testing Distance : 8-12KM)	800.00
	TT-VFL-20MW	Visual Fault Locator 20mw Output (Testing Distance : 20KM)	1,200.00
	TT-VFL-30MW	Visual Fault Locator 30mw Output (Testing Distance : 30KM)	1,800.00
	TT-OFI	Optical Fiber Identifier	12,000.00
	TT-FFM	Field Fiber Microscope	2,800.00
	TT-FC	Fiber Cleaver	1,500.00
	TT-AL	Alcohol 100% for cleaner 1000 ML.	1,200.00
	TT-F-TOOL-01	Fibre Optical Tool Kit 1	15,000.00
	TT-F-TOOL-02	Fibre Optical Tool Kit 2	15,000.00
	TT-F-TOOL-03	Fibre Optical Tool Kit 3	13,000.00

บริษัท โฟคอมม (ประเทศไทย) จำกัด

12 ซอยสุขาภิบาล 5 ซอย 5 แยก 3 แขวงท่าแร้ง เขตบางเขน กรุงเทพฯ 10220 โทร. 063-391-5262 โทร. 02-557-6451 แฟกซ์. 02-557-6452

www.focomm-cabling.com

## Test

### FOCOMM Power Meter



#### Features

- 4-digit LCD display, supporting four display formats : mw, uw, nw, dBm
- Automatic range switching
- Automatic power-off
- Multi-wavelength measurement
- Low power indication

### FOCOMM Power Meter (PON)



#### Features

- 4-digit LCD display, supporting four display formats : mw, uw, nw, dBm
- Automatic range switching
- Automatic power-off
- Multi-wavelength measurement
- Low power indication

### FOCOMM Optical Light Source (850/1300/1310/1550 nm)



#### Features

- With SC Adaptor and FC Adaptor
- Power supply : 3PCS AA 1.5V battery
- High stability of the output power
- Stable output wavelength
- 850/1300/1310/1550 wavelength

### FOCOMM Launch Box



#### Features

- Use as a Pulse Suppressor, OTDR Launch/Receive Cable, Delay Line, Training, Product Demonstrations.
- Leads wrap in the same direction for quick easy access and storage

### FOCOMM Fusion Splicer (With toolbox and tools)



#### Features

- Application Scenarios : FTTH
- Alignment method : Clad to clad alignment, 4 motors
- Number of fiber : Single fiber
- Type of fiber : SM / MM / DS / NZDS
- Diameter of fiber : 0.25-0.3mm / Indoor Cable
- Fiber placement and cutting length : Coating diameter 0.125-1mm / cleave length 8-16mm
- Splicing mode : Multiple splicing modes
- Typical splice loss : 0.01dB-0.05dB
- Return loss :  $\geq 60$ dB
- Lighting : 3 High-power LED white light
- Splicing time : 6-10s

### FOCOMM OTDR Tester



#### Features

- FC/UPC (PC, and APC are selectable)
- USB interface, SD card interface
- Wavelength : 650nm
- Output power (dBm) :  $\geq -3$
- Maximum testing distance : 3km

### FOCOMM Mini OTDR Tester



#### Features

- Determine fiber optic cable or fiber optic's failure point, connection point
- Describe fiber optic cable or fiber's loss
- Measure fiber optic cable, optical fiber connector's insertion loss

## Fiber Glass Duct Rodder



Diameter : 600mm  
Height : 630mm



Diameter : 900mm  
Height : 980mm



Diameter : 1100mm  
Height : 1150mm



Diameter : 1300mm  
Height : 1350mm

#### Features

- Other length can supply as per customer's request
- Colour of fiber glass : Yellow or white

### Ordering Table

PRODUCT	PART NUMBER	DESCRIPTION	PRICE
Test	TT-PM-01	FOCOMM Power Meter	3,000.00
	TT-PM-PON-01	FOCOMM Power Meter (PON)	8,000.00
	TT-LS-01	FOCOMM Optical Light Source (850/1300/1310/1550 nm)	8,000.00
	TT-LB-01	FOCOMM Launch Box	3,000.00
	TT-GF-900T	FOCOMM Fusion Splicer (with toolbox and tools)	63,000.00
Fiber Glass Duct Rodder	TT-OTDR-TR600	FOCOMM OTDR Tester	60,000.00
	TT-OTDR-TR300	FOCOMM Mini OTDR Tester	50,000.00
	TT-FGDR-80M	8mm OD Fiber Glass (80M/Roll)	8,000.00
	TT-FGDR-100M	9mm OD Fiber Glass (100M/Roll)	10,000.00
	TT-FGDR-200M	12mm OD Fiber Glass (200M/Roll)	20,000.00
	TT-FGDR-250M	11mm OD Fiber Glass (250M/Roll)	22,000.00
	TT-FGDR-300M	13mm OD Fiber Glass (300M/Roll)	25,000.00
	TT-FGDR-350M	12mm OD Fiber Glass (350M/Roll)	27,000.00
	TT-FGDR-400M	11mm OD Fiber Glass (400M/Roll)	30,000.00

บริษัท โฟคคอมม์ (ประเทศไทย) จำกัด

12 ซอยสุขาภิบาล 5 ซอย 5 แยก 3 แขวงท่าแร้ง เขตบางเขน กรุงเทพฯ 10220 โทร. 063-391-5262 โทร. 02-557-6451 แฟกซ์. 02-557-6452

www.focomm-cabling.com

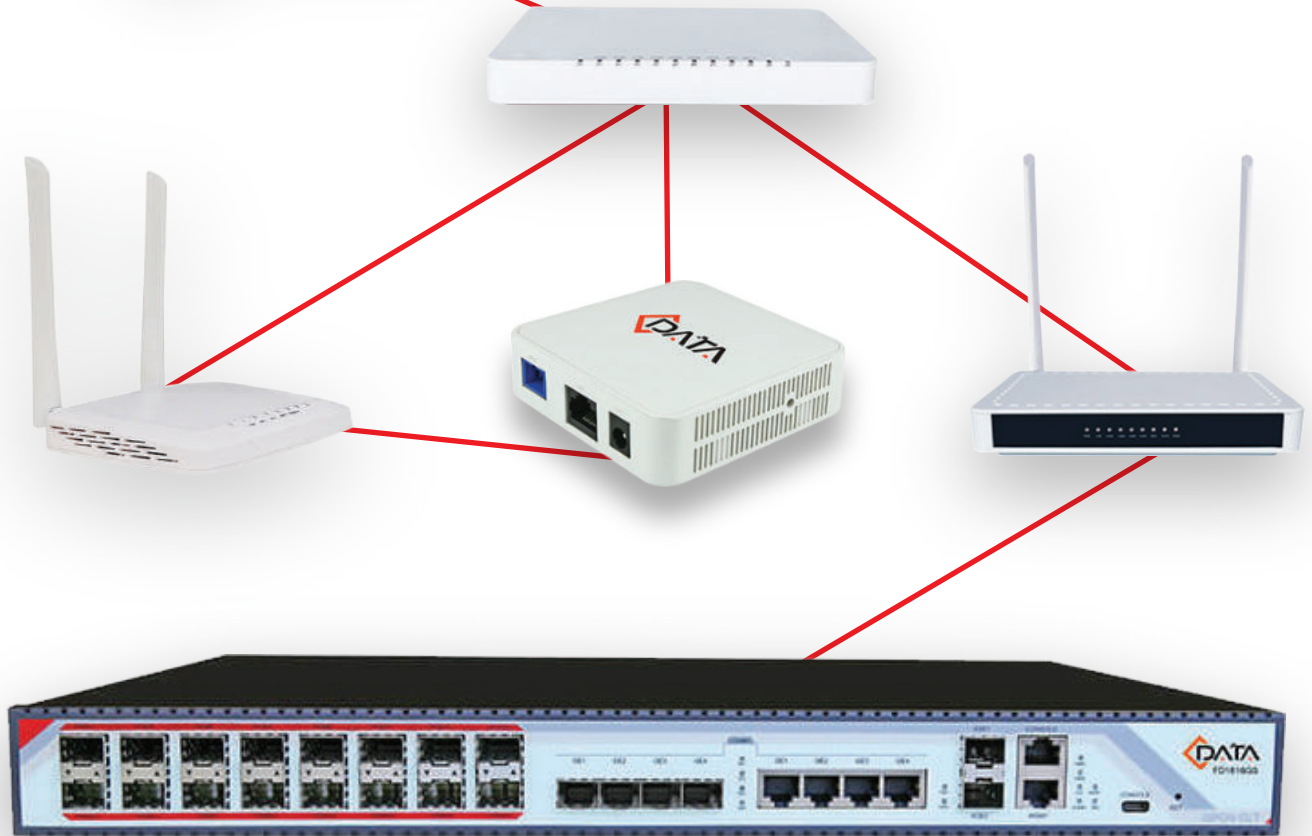

**OLT**  

---

**ONU**

# OLT-ONU Product

- GPON OLT
- GPON ONU
- EPON OLT
- EPON ONU Data EPON ONU
- EPON ONU





## GPON OLT

### 8PORTS GPON OLT



#### Features

- 1U height 8PON OLT product in compact design of Pizza-Box
- Layer 2 Switching Function
- Layer 3 Routing Function
- QOSGuarantee

### 16PON GPON OLT



#### Features

- 1 USB interface
- 4 uplink COMBO ports, 2 uplink 10-gigabit optical ports
- power supply of 220VAC / -48VDC, support dual power redundancy configuration
- support BBU

## GPON ONU

### 1GE PON PORT GPON ONU



#### Features

- one GE auto-adapting Ethernet ports
- based on ZTE high-performance xPON access chip.
- The chip supposes three mode : GPON/EPON/P2P
- apply in FTTH/FTTO to provide the data and video service based on the GPON network.

### 1GE DUAL-MODE ONU



#### Features

- Support both GPON and EPON mode adaptation
- Fullycompatible with ITU-T 984.1/2/3/4
- Support downlink rate 2.448Gbit/s, uplink rate is 1.244Gbit/s
- Support 32 TCONT,256 GEMPORT

### 8PON GPON OLT



#### Features

- 1Uheight 8PON OLT product in compact design of Pizza-Box
- Layer 2 Switching Function
- QOSGuarantee
- Easy-to-Use Management System

### 16PON GPON OLT



#### Features

- 1Uheight 16PON OLT product in compact design of Pizza-Box
- Layer 2 Switching Function
- QOSGuarantee
- Easy-to-Use Management System

### 1GE DUAL-MODE ONU



#### Features

- Support both GPON and EPON mode adaptation
- Fullycompatible with ITU-T 984.1/2/3/4
- Support downlink rate 2.448Gbit/s, uplink rate is 1.244Gbit/s
- Support 32 TCONT,256 GEMPORT

### 1GE GPON ONU



#### Features

- Fullycompatible with ITU-T 984.1/2/3/4
- Support POE supply power(PD)
- Meet 3afstandard
- SupportPOE switch power supply

## Ordering Table

PRODUCT	PART NUMBER	DESCRIPTION	PRICE
GPON OLT	FD1608GS	8PORTS GPON OLT	Call
	FD1608SN	8PON GPON OLT	108,000.00
	FD1616GS	16PON GPON OLT	Call
	P-SW-12V-10A	16PON GPON OLT	Call
GPON ONU	FD600-511G	1GE PON PORT GPON ONU	1,500.00
	FD600-521G-HZ630	1GE DUAL-MODE ONU	Call
	FD600-521G-HZ660	1GE DUAL-MODE ONU	Call
	FD600-511GP-HZ600	1GE GPON ONU	Call

บริษัท โฟคคอมม์ (ประเทศไทย) จำกัด

12 ซอยสุขาภิบาล 5 ซอย 5 แยก 3 แขวงท่าแร้ง เขตบางเขน กรุงเทพฯ 10220 โทร. 063-391-5262 โทร. 02-557-6451 แฟกซ์. 02-557-6452

www.focomm-cabling.com

## 4GE FD600-504 SERIES GPON ONU

### HR220



#### Features

- Support prot-based rate limitation and bandwidth control
- In compliant with ITU-TG.984 standard
- WiFi series meet 802.11 n/b/g technical standards
- Support data encryption,group broadcasting,port vlan seperation,etc.

### HR640



#### Features

- Support prot-based rate limitation and bandwidth control
- In compliant with ITU-TG.984 standard
- WiFi series meet 802.11 n/b/g technical standards
- Support data encryption,group broadcasting,port vlan seperation,etc.

### HR650



#### Features

- Support prot-based rate limitation and bandwidth control
- In compliant with ITU-TG.984 standard
- WiFi series meet 802.11 n/b/g technical standards
- Support data encryption,group broadcasting,port vlan seperation,etc.

### HR700



#### Features

- Support prot-based rate limitation and bandwidth control
- In compliant with ITU-TG.984 standard
- WiFi series meet 802.11 n/b/g technical standards
- Support data encryption,group broadcasting,port vlan seperation,etc.

## 1GE PON PORT GPON ONU



#### Features

- Mini appearance
- One 10/100/1000M auto-negotiable Ethernet port
- One GPON optical port

## 1GE + WIFI GPON ONU



#### Features

- 1GE DATA GPON ONU
- In compliant with ITU – T G.984Standard
- Wi-Fi meet 11 n/b/gtechnical standards

### Ordering Table

PRODUCT	PART NUMBER	DESCRIPTION	PRICE
HR220	FD600-504F-HR220	4*10/100M Ethernet interface, 1 GPON interface, plastic casing, external power supply adapter	Call
	FD600-504G-HR220	4*10/100/1000M Ethernet interface, 1 GPON interface, plastic casing, external power supply adapter	2,200.00
	FD600-504FW-HR220	4*10/100M Ethernet interface, 1 GPON interface, support Wifi function, plastic casing, external power supply adapter	Call
	FD600-504GW-HR220	4*10/100/1000M Ethernet interface, 1 GPON interface, support Wifi function, plastic casing, external power supply adapter	2,500.00
HR640	FD600-504F-HR640	4*10/100M Ethernet interface, 1 GPON interface, plastic casing, external power supply adapter	Call
	FD600-504X-HR640	1*10/100/1000M and 3*10/100M Ethernet interface, 1 GPON interface, plastic casing, external power supply adapter	Call
	FD600-504G-HR640	4*10/100/1000M Ethernet interface, 1 GPON interface, plastic casing, external power supply adapter	2,200.00
HR650	FD600-504F-HR650	4*10/100M Ethernet interface, 1 GPON interface, plastic casing, external power supply adapter	Call
	FD600-504X-HR650	1*10/100/1000M and 3*10/100M Ethernet interface, 1 GPON interface, plastic casing, external power supply adapter	Call
	FD600-504G-HR650	4*10/100/1000M Ethernet interface, 1 GPON interface, plastic casing, external power supply adapter	2,200.00
HR700	FD600-504F-HR700	4*10/100M Ethernet interface, 1 GPON interface, plastic casing, external power supply adapter	Call
	FD600-504G-HR700	4*10/100/1000M Ethernet interface, 1 GPON interface, plastic casing, external power supply adapter	2,200.00
	FD600-504FW-HR700	4*10/100M Ethernet interface, 1 GPON interface, support Wifi function, plastic casing, external power supply adapter	Call
	FD600-504GW-HR700	4*10/100/1000M Ethernet interface, 1 GPON interface, support Wifi function, plastic casing, external power supply adapter	2,500.00
GPON ONU	FD511HZ	1*GE Ethernet interface, 1 GPON interface, plastic casing, external power supply adapter	Call
	FD600-511GW-HR630	1*10/100/1000M Ethernet interface, 1 GPON interface, Support 300Mbps wifi ,plastic casing, external power supply adapter	1,800.00

## EPON OLT

### 1U PIZZA-BOX 4PON EPON OLT



#### Features

- Support port VLAN and protocol VLAN
- Online ONU configuration and management
- In compliant with IEEE802.3ah Standard
- Support dynamic distance calculation on EMS online

### 1 U 8PON EPON OLT



#### Features

- Online ONU configuration and management
- Support port VLAN and protocol VLAN
- Double 220VAC or -48VDC redundancy power supply
- Support dynamic distance calculation on EMS online

### 4PON GEAPON OLT



#### Features

- 1 USB interface
- 4 uplink combo interface
- 2\*10Gb uplink interface
- 4 EPON ports for downstream

### 8PON EPON OLT



#### Features

- 1 USB interface
- 4GE(copper) and 4GE optical interface
- 4\*10Gb uplink interface
- 8 EPON ports for downstream

### 1U 16PON PORT PIZZA-BOX EPON OLT



#### Features

- 16 PON ports in 1U pizza-box EPON OLT
- 1 USB interface
- Two uplink 10Gbps SFP slots
- Double 220VAC or -48VDC redundancy power supply

### 16PON PORT CARD INSERTED EPON



#### Features

- In compliant with IEEE802.3ah Standard
- SNMP, Telnet, CLI management mode
- Support port VLAN and protocol VLAN

### CHON OUTDOOR TYPE EPON OLT& EDFA & WDM



#### Features

- Integrated with OLT and EDFA
- Support 256 ONU under 1:64 splitter ratio
- High performance

### EMS

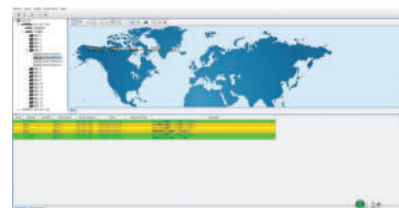

#### Features

- Based on standard SNMP protocol
- Support multiple client access, C/S architecture
- Support integrated management all our EPON series products

### Ordering Table

PRODUCT	PART NUMBER	DESCRIPTION	PRICE
GPON OLT	FD1104SN	1U PIZZA-BOX 4PON EPON OLT	30,000.00
	FD1108S	1 U 8PON EPON OLT	50,000.00
	FD1204SN	4PON GEAPON OLT	38,000.00
	FD1208S-R2	8PON EPON OLT	55,000.00
GPON ONU	FD1216S-R1	1U 16PON PORT PIZZA-BOX EPON OLT	92,000.00
	OLT-FD8000-L116	16PON PORT CARD INSERTED EPON	100,000.00
	FD1104Y-ED2204W	CHON OUTDOOR TYPE EPON OLT& EDFA & WDM	92,000.00
	EMS	EMS	Free

บริษัท โฟค้อมม (ประเทศไทย) จำกัด

12 ซอยสุขาภิบาล 5 ซอย 5 แยก 3 แขวงท่าแร้ง เขตบางเขน กรุงเทพฯ 10220 โทร. 063-391-5262 โทร. 02-557-6451 แฟกซ์. 02-557-6452

www.focomm-cabling.com

## EPON ONU Data

### 1GE MINI EPON ONU



#### Features

- Full compatible with IEEE802.3ah
- Support software online upgrading
- Support three layer routing functions
- EMS network management based on SNMP ,convenient for maintenance

### 1GE DUAL-MODE ONU



#### Features

- Support both GPON and EPON mode adaptation
- Fullycompatible with ITU-T 984.1/2/3/4
- Support downlink rate 2.448Gbit/s, uplink rate is 1.244Gbit/s
- Support 32 TCONT,256 GEMPORT

### 1GE WI-FI EPON ONU



#### Features

- 1\*10/100/1000M Ethernet interface
- Built-in WiFi
- 1 EPON interface
- In compliant with IEEE802.3ah Standard

### 1GE OUTDOOR EPON ONU



#### Features

- Waterproof Aluminum alloy die casting shaping, good heat dissipation
- Built-in one ONU module
- One or Four 10/100/1000M auto-negotiable Ethernet port
- EMS network management based on SNMP

### 1GE DUAL-MODE ONU



#### Features

- Support both GPON and EPON mode adaptation
- Fullycompatible with ITU-T 984.1/2/3/4
- Support downlink rate 2.448Gbit/s, uplink rate is 1.244Gbit/s
- Support 32 TCONT,256 GEMPORT

### 1GE EPON ONU



#### Features

- Full compatible with IEEE802.3ah standard
- Support POE supply power(PD)
- Meet 3afstandard
- SupportPOE switch power supply

### 1GE WI-FI EPON ONU



#### Features

- Mini appearance
- One 10/100/1000M auto-negotiable Ethernet port
- One EPON optical port
- Support routing function

## Ordering Table

PRODUCT	PART NUMBER	DESCRIPTION	PRICE
Data EPON ONU	FD600-111G	1GE MINI EPON ONU	10,000.00
	FD600-521G-HZ630	1GE DUAL-MODE ONU	Call
	FD600-521G-HZ660	1GE DUAL-MODE ONU	Call
	FD600-111GP-HZ600	1GE EPON ONU	Call
	FD600-111GW-HR700	1GE WI-FI EPON ONU	1,600.00
	FD111HZ	1GE WI-FI EPON ONU	Call
	FD111Y/ FD114Y	1GE OUTDOOR EPON ONU	3,200.00

บริษัท โฟคอมม (ประเทศไทย) จำกัด

12 ซอยสุขาภิบาล 5 ซอย 5 แยก 3 แขวงท่าแร้ง เขตบางเขน กรุงเทพฯ 10220 โทร. 063-391-5262 โทร. 02-557-6451 แฟกซ์. 02-557-6452

www.focomm-cabling.com



## FD600-104 SERIES EPON ONU (INCLUDES WI-FI SERIES)

HR220



### Features

- Support port-based rate limitation and bandwidth control;
- In compliant with IEEE802.3ah Standard
- Wi-Fi series meet 11 n/b/g technical standards
- Up to 20KM transmission Distance
- Support data encryption, group broadcasting, port Vlan separation ,etc.
- Support Dynamic Bandwidth Allocation (DBA)
- Support ONU auto-discovery/Link detection/remote upgrade of software

HR640



### Features

- Support port-based rate limitation and bandwidth control
- In compliant with IEEE802.3ah Standard
- Wi-Fi series meet 11 n/b/g technical standards
- Up to 20KM transmission Distance
- Support data encryption, group broadcasting, port Vlan separation ,etc.
- Support Dynamic Bandwidth Allocation (DBA)
- Support ONU auto-discovery/Link detection/remote upgrade of software

HR650



### Features

- Support port-based rate limitation and bandwidth control;
- In compliant with IEEE802.3ah Standard
- Wi-Fi series meet 11 n/b/g technical standards
- Up to 20KM transmission Distance
- Support data encryption, group broadcasting, port Vlan separation ,etc.
- Support Dynamic Bandwidth Allocation (DBA)
- Support ONU auto-discovery/Link detection/remote upgrade of software

HR700



### Features

- Support port-based rate limitation and bandwidth control;
- In compliant with IEEE802.3ah Standard
- Wi-Fi series meet 11 n/b/g technical standards
- Up to 20KM transmission Distance
- Support data encryption, group broadcasting, port Vlan separation ,etc.
- Support Dynamic Bandwidth Allocation (DBA)
- Support ONU auto-discovery/Link detection/remote upgrade of software

## Ordering Table

PRODUCT	PART NUMBER	DESCRIPTION	PRICE
HR220	FD600-104F-HR220	4*10/100M Ethernet interface, 1 EPON interface, plastic casing, external power supply adapter	Call
	FD600-104G-HR220	4*10/100/1000M Ethernet interface, 1 EPON interface, plastic casing, external power supply adapter	1,800.00
	FD600-104FW-HR220	4*10/100M Ethernet interface, support Wi-Fi function, 1 EPON interface, plastic casing, external power supply adapter	Call
HR640	FD600-104GW-HR220	4*10/100/1000M Ethernet interface, support Wi-Fi function, 1 EPON interface, plastic casing, external power supply adapter	2,400.00
	FD600-104F-HR640	4*10/100M Ethernet interface, 1 EPON interface, plastic casing, external power supply adapter	Call
	FD600-104X-HR640	1*10/100/1000 and 3*10/100M Ethernet interface, 1 EPON interface, plastic casing, external power supply adapter	1,600.00
HR650	FD600-104G-HR640	4*10/100/1000M Ethernet interface, 1 EPON interface, plastic casing, external power supply adapter	1,800.00
	FD600-104F-HR650	4*10/100M Ethernet interface, 1 EPON interface, plastic casing, external power supply adapter	Call
	FD600-104X-HR650	1*10/100/1000 and 3*10/100M Ethernet interface, 1 EPON interface, plastic casing, external power supply adapter	1,600.00
HR700	FD600-104G-HR650	4*10/100M Ethernet interface, support Wi-Fi function, 1 EPON interface, plastic casing, external power supply adapter	1,800.00
	FD600-104F-HR700	4*10/100M Ethernet interface, 1 EPON interface, plastic casing, external power supply adapter	Call
	FD600-104G-HR700	4*10/100/1000M Ethernet interface, 1 EPON interface, plastic casing, external power supply adapter	1,800.00
	FD600-104FW-HR700	4*10/100M Ethernet interface, support Wi-Fi function, 1 EPON interface, plastic casing, external power supply adapter	Call
	FD600-104GW-HR700	4*10/100/1000M Ethernet interface, support Wi-Fi function, 1 EPON interface, plastic casing, external power supply adapter	2,400.00

## Voice EPON ONU

### 4GE 2 POTS VOICE EPON ONU



#### Features

- Full compatible with IEEE802.3ah
- Support two POTS
- Support four GE auto-adapting Ethernet ports
- Support OAM and TR069 for remote management

### 2GE 1 POTS EPON ONU



#### Features

- Full compatible with IEEE802.3ah
- Support one POTS
- Support two GE auto-adapting Ethernet ports
- Support OAM and TR069 for remote management

### 4GE+ 2POTS + CATV TRIPLE-PLAY EPON ONU



#### Features

- In compliant with IEEE802.3ah Standard and CTC2.1
- Up to 20KM transmission Distance
- Support VLAN and IGMP
- Support port isolation between different ports
- Support Wi-Fi function

### 4GE 2 POTS VOICE EPON ONU WiFi PORT



#### Features

- Full compatible with IEEE802.3ah
- Support two POTS
- Support four GE auto-adapting Ethernet ports
- Support OAM and TR069 for remote management

### 2GE 1 POTS WIFI EPON ONU



#### Features

- Full compatible with IEEE802.3ah
- Support two POTS
- Support four GE auto-adapting Ethernet ports
- Support OAM and TR069 for remote management

### 4GE+ 2POTS + CATV TRIPLE-PLAY EPON ONU



#### Features

- In compliant with IEEE802.3ah Standard and CTC2.1
- Up to 20KM transmission Distance
- Support VLAN and IGMP
- Support port isolation between different ports

## Ordering Table

PRODUCT	PART NUMBER	DESCRIPTION	PRICE
Voice EPON ONU	FD214GH	4*GE Ethernet interface, 2*POTS interface, 1*EPON interface	2,400.00
	FD214GW	4*GE Ethernet interface, 2*POTS interface, 1*EPON interface, support Wi-Fi function	2,800.00
	FD212H	1*10/100M and 1*10/100/1000M Ethernet interface, 1*POTS port, 1 EPON interface	Call
	FD212GW	2*GE Ethernet interface, 1*POTS interface, 1*EPON interface, support Wi-Fi function	Call
4GE + 2POTS +	FD404GW	1 EPON interface, 2 POTS interface, support Wi-Fi function, Input optical power -15dBm~0dBm, Plastic casing	3,700.00
CATV+ Wi-Fi	FD404GWL	1 EPON interface, 2 POTS interface, support Wi-Fi function, Input optical power -18dBm~-9dBm, Plastic casing	Call
	FD404GWA	1 EPON interface, 2 POTS interface, support Wi-Fi and AGC function, Input optical power -18dBm~0dBm, Plastic casing	Call
4GE + 2POTS + CATV	FD404GH	1 EPON interface, 2 POTS interface, Input optical power -15dBm~0dBm ,Plastic casing, external power supply adapter	3,200.00
	FD404GHL	1 EPON interface, 2 POTS interface, Input optical power -18dBm~-9dBm ,Plastic casing, external power supply adapter	Call
	FD404GHA	1 EPON interface, 2 POTS interface, Input optical power -18dBm~0dBm ,support AGC function, Plastic casing	Call

## CATV EPON ONU

### 1GE CATV WIFI EPON ONU



#### Features

- 1\*10/100/1000M Ethernet interface
- 1 EPON interface
- built-in FWDM
- Support WiFi function and AGC function

### 1GE + CATV EPON ONU



#### Features

- 1\*10/100/1000M Ethernet interface
- In compliant with IEEE802.3ah Standard
- Up to 20KM transmission Distance
- Support data encryption, group broadcasting, port Vlan separation ,etc.

### 4GE CATV EPON ONU



#### Features

- CATV EPON ONU, Built-in FWDM
- Support AGC function
- 1 EPON interface
- Input optical power -18dBm~0dBm
- EMS network management based on SNMP , convenient for maintenance

### 1GE + CATV EPON ONU



#### Features

- Support port-based rate limitation and bandwidth control;
- In compliant with IEEE802.3ah Standard
- Up to 20KM transmission Distance
- Support data encryption, group broadcasting, port Vlan separation ,etc.

### 1GE+1FE+CATV EPON ONU



#### Features

- 1\*10/100/1000M and 1\*10/100 Ethernet interface
- In compliant with IEEE802.3ah Standard
- Wi-Fi series meet 11 n/b/g technical standards
- Up to 20KM transmission Distance

### 4GE CATV EPON ONU



#### Features

- CATV EPON ONU, Built-in FWDM
- Support AGC function
- 1 EPON interface
- Input optical power -18dBm~0dBm
- EMS network management based on SNMP , convenient for maintenance

## Ordering Table

PRODUCT	PART NUMBER	DESCRIPTION	PRICE
CATV EPON ONU	FD600-301GW-HR220	Built-in FWDM, Input optical power -18dBm~0dBm, support WiFi function and AGC function	2,600.00
	FD600-301GA-HZ220	Built-in FWDM, Input optical power-18dBm~0dBm, support AGC function	2,000.00
	FD600-301GA-HZ630	1 RF interface, 1 EPON interface, built-in FWDM, Input optical power -12dBm~2dBm	2,000.00
	FD600-302XW-HR210	1 RF Interface, 1 EPON interface, built-in FWDM, support WiFi functio	2,600.00
4GE CATV WIFI	FD600-304FA-HR501	4*10/100M Ethernet interface, 1 RF interface, 1 EPON interface, built-in FWDM	Call
	FD600-304GA-HR501	4*10/100/1000M Ethernet interface, 1 RF interface, 1 EPON interface, built-in FWDM	2,800.00
	FD600-304XA-HR501	3*10/100M and 1*10/100/1000M Ethernet interface, 1 RF interface, 1 EPON interface, built-in FWDM	2,700.00
	FD600-304FA-HR511	4*10/100M Ethernet interface, 1 RF interface, 1 EPON interface, built-in FWDM	Call
	FD600-304GA-HR511	4*10/100/1000M Ethernet interface, 1 RF interface, 1 EPON interface, built-in FWDM	2,800.00
	FD600-304XA-HR511	3*10/100M and 1*10/100/1000M Ethernet interface, 1 RF interface, 1 EPON interface, built-in FWDM	Call

## CATV EPON ONU

### 4GE CATV WIFI EPON ONU



#### Features

- CATV EPON ONU, Built-in FWDM
- 4\*10/100/1000M Ethernet interface, 1 EPON interface
- Input optical power -18dBm~0dBm
- Support WI-FI and AGC function

### 4GE CATV WIFI EPON ONU



#### Features

- CATV EPON ONU, Built-in FWDM
- 4\*10/100/1000M Ethernet interface, 1 EPON interface
- Input optical power -18dBm~0dBm
- Support WI-FI and AGC function

## 4GE+ 2POTS + CATV TRIPLE-PLAY EPON ONU



#### Features

- 4GE+ 2POTS + CATV Triple play
- Plug and play, integrated auto detecting, auto configuration, and auto firmware upgrade technology
- EMS network management based on SNMP, convenient for maintenance
- Full speed non-blocking switching.

### Ordering Table

PRODUCT	PART NUMBER	DESCRIPTION	PRICE
CATV EPON ONU	FD600-304FAW-HR501	4*10/100M Ethernet interface, 1 RF interface, 1 EPON interface, built-in FWDM	Call
	FD600-304GAW-HR501	4*10/100/1000M Ethernet interface, 1 RF interface, 1 EPON interface, built-in FWDM	3,500.00
	FD600-304XAW-HR501	3*10/100M and 1*10/100/1000M Ethernet interface, 1 RF interface, 1 EPON interface, built-in FWDM	3,400.00
	FD600-304FAW-HR511	4*10/100M Ethernet interface, 1 RF interface, 1 EPON interface, built-in FWDM	Call
	FD600-304GAW-HR511	4*10/100/1000M Ethernet interface, 1 RF interface, 1 EPON interface, built-in FWDMr	3,500.00
	FD600-304XAW-HR511	3*10/100M and 1*10/100/1000M Ethernet interface, 1 RF interface, 1 EPON interface, built-in FWDM	3,400.00
	FD404GW	4*10/100/1000M Ethernet interface, 1 EPON interface, 2 POTS interface, support Wi-Fi function	2,700.00



## OLT - ONU Solution

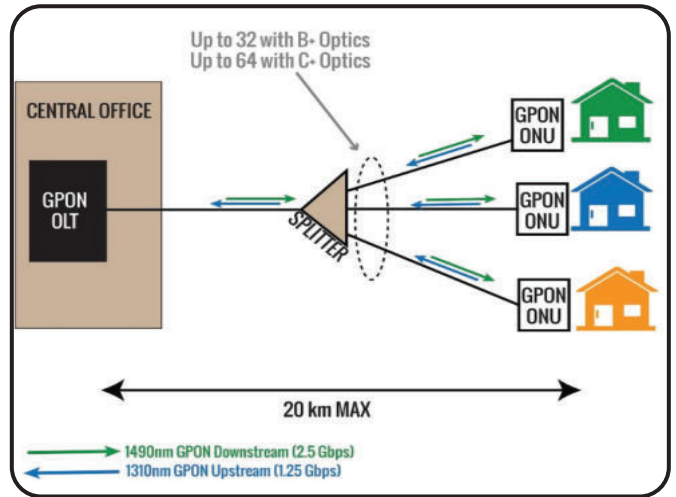
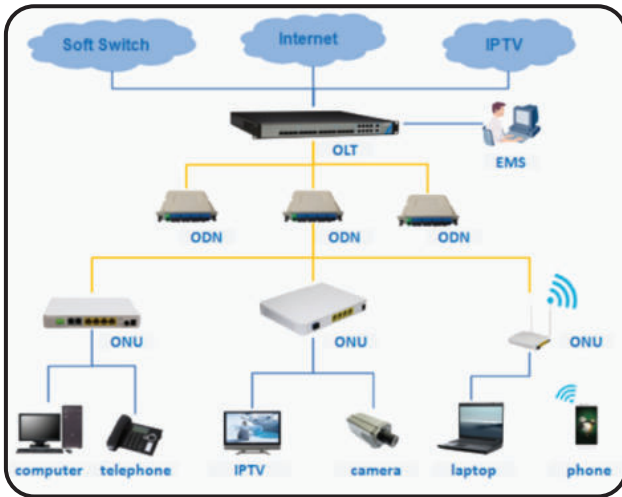

ระบบ PON มีส่วนประกอบดังนี้

OLT = Optical Line Terminal เป็นอุปกรณ์ควบคุมเครือข่าย FTTx โดยจะรับข้อมูลจากทางผู้ให้บริการแล้วส่งข้อมูลไปยังบ้านต่าง ๆ

Splitter, ODN = เป็นตัวที่จะแตกสาย Fiber ออกเป็นหลายๆเส้นเพื่อเดินทางไปยังแต่ละบ้าน

ONU = Optical Network Unit จะถูกติดตั้งเป็น Router อยู่ตามบ้านเพื่อทำหน้าที่รับข้อมูลจาก OLT ทำให้บ้านนั้น ๆ สามารถใช้งาน Internet ได้

การรับส่งข้อมูลระหว่าง OLT และ ONU

ONU ก็ตัว ลงทะเบียน กำหนดเลขหมายประจำตัว และจัดสรรช่วงเวลาต่างๆให้เรียบร้อย จากนั้นจึงเริ่มขบวนการ Downstream OLT จะส่งข้อมูลไปให้ ONU แบบ Broadcast คือทุก ONU เห็นข้อมูลเหมือนกันหมด แต่ข้อมูลนั้นมีเลขหมายประจำตัวอยู่ ถ้า ONU เห็นเลขหมายของตัวเอง ก็รับข้อมูลนั้น ถ้าไม่เห็น ก็ไม่รับ

Upstream OLT ทำงานแบบ TDMA (Time Division Multiplex Access) คือจะจัดสรรเวลาให้แต่ละ ONU เมื่อถึงเวลาที่กำหนดให้ของ ONU ตัวไหน ตัวนั้นก็ส่ง ข้อมูลของแต่ละ ONU ก็จะทยอยกันเข้ามาที่ OLT

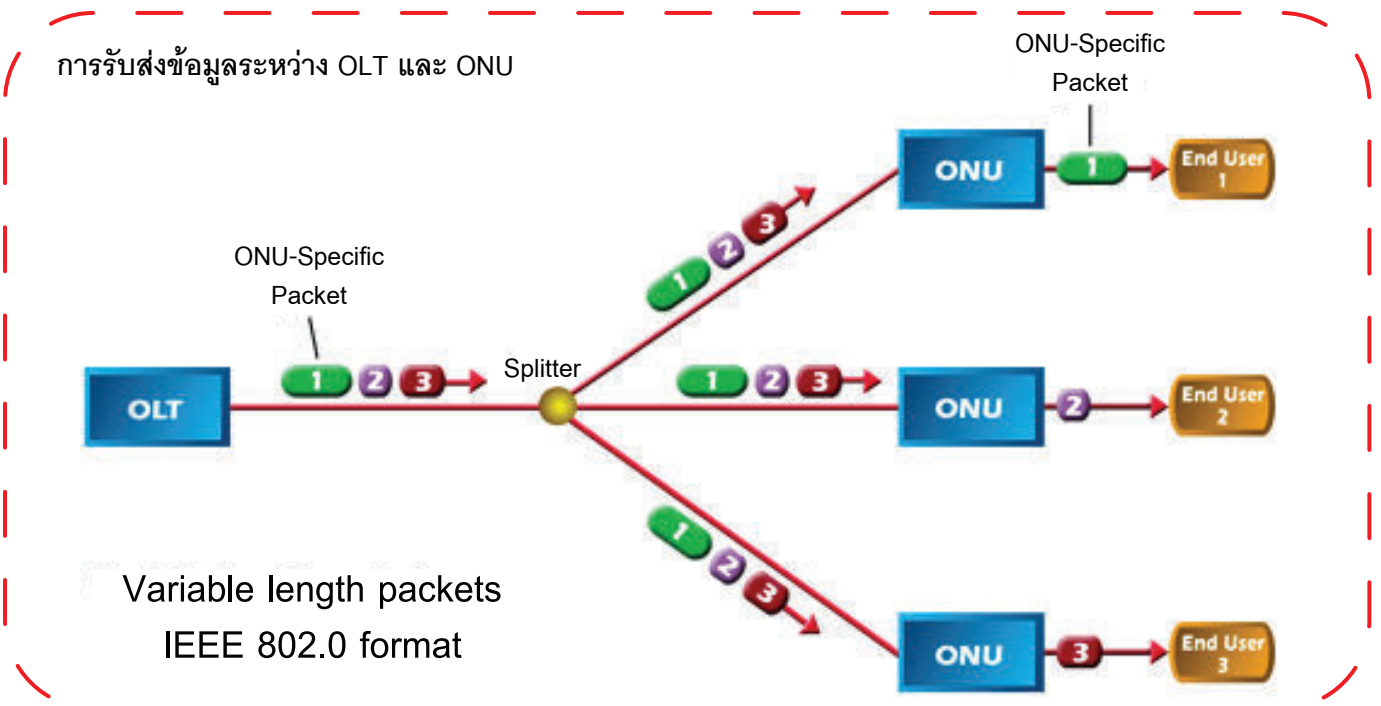

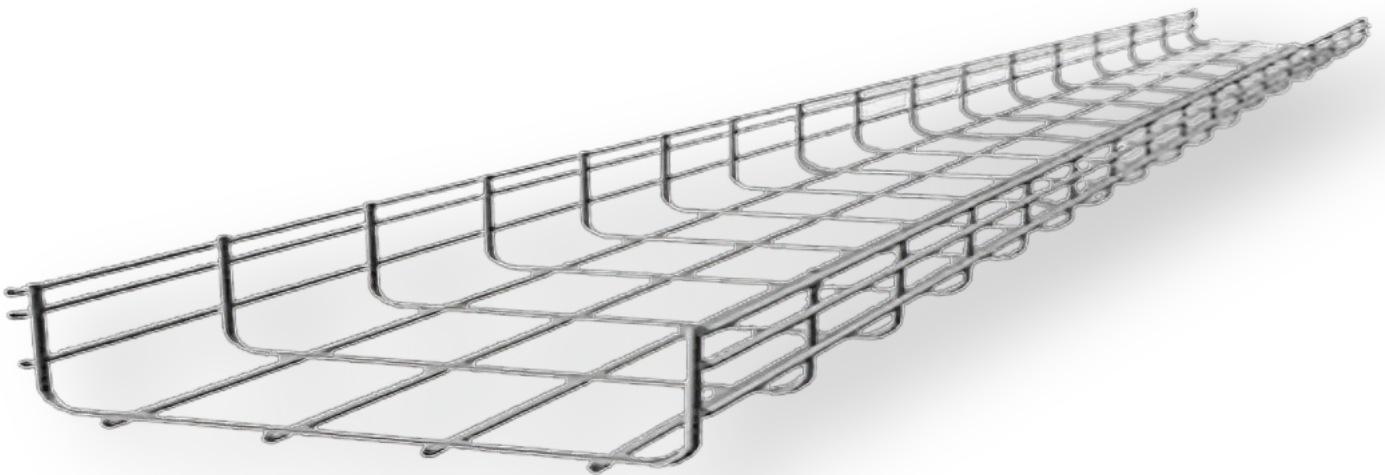

# WIRE MESH/FIBER WAY

- WIRE MESH CABLE TRAY
- FIBER CABLE TRAY



# Wire Mesh/Fiber Tray Product



## WIRE MESH CABLE TRAY

The second generation open type wire mesh cable tray designed by Lepin, includes indoor and outdoor use, widely used in installation cable in different telecommunication houses, electricity units and engineering project.

Feature: easy to install, excellent cable ventilation, energy saving,

easy for maintenance and update

Material: carbon steel (Q235B), stainless steel (304 / 316L)

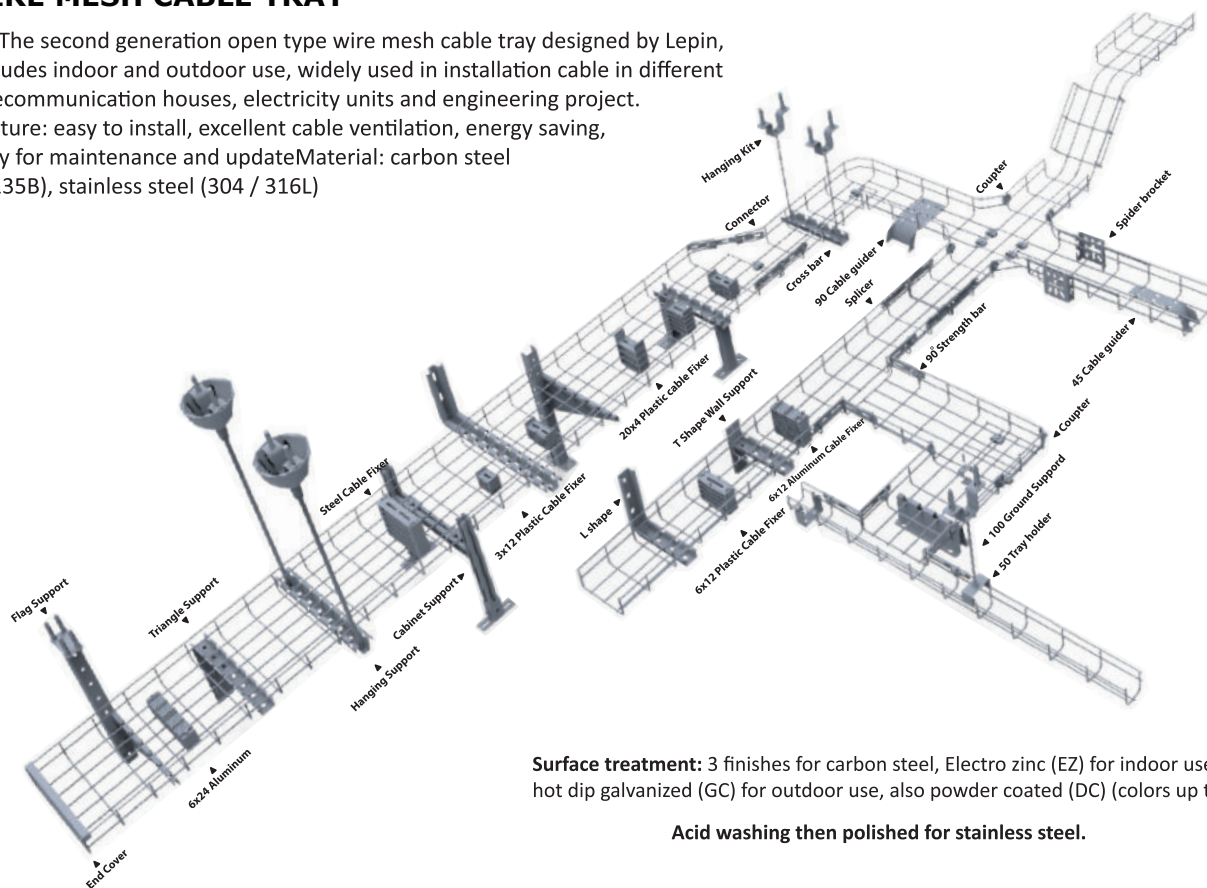

**Surface treatment:** 3 finishes for carbon steel, Electro zinc (EZ) for indoor use, hot dip galvanized (GC) for outdoor use, also powder coated (DC) (colors up to customer).

Acid washing then polished for stainless steel.



WIRE MESH CABLE TRAY



WIRE MESH CABLE TRAY



WIRE MESH CABLE TRAY

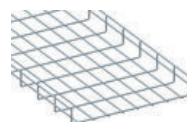

WIRE MESH CABLE TRAY



WIRE MESH CABLE TRAY



COUPLER



STRENGTH BAR



CORNER STRENGTH BAR



ΩBAR

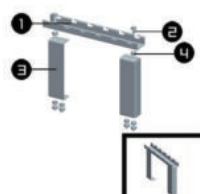

CABINET TOP STAND



WALL BRACKET



CABLE GUIDER

บริษัท โฟคอมม (ประเทศไทย) จำกัด

12 ซอยสุขาภิบาล 5 ซอย 5 แยก 3 แขวงท่าแร้ง เขตบางเขน กรุงเทพฯ 10220 โทร. 063-391-5262 โทร. 02-557-6451 แฟกซ์. 02-557-6452

www.focomm-cabling.com

## FIBER CABLE TRAY

FIBERFLOW® FIBER MANAGEMENT SYSTEMS is designed to protect and route fiber optic patch cords. Manage cable assemblies to and from network cabinets, ODF and other terminal devices.

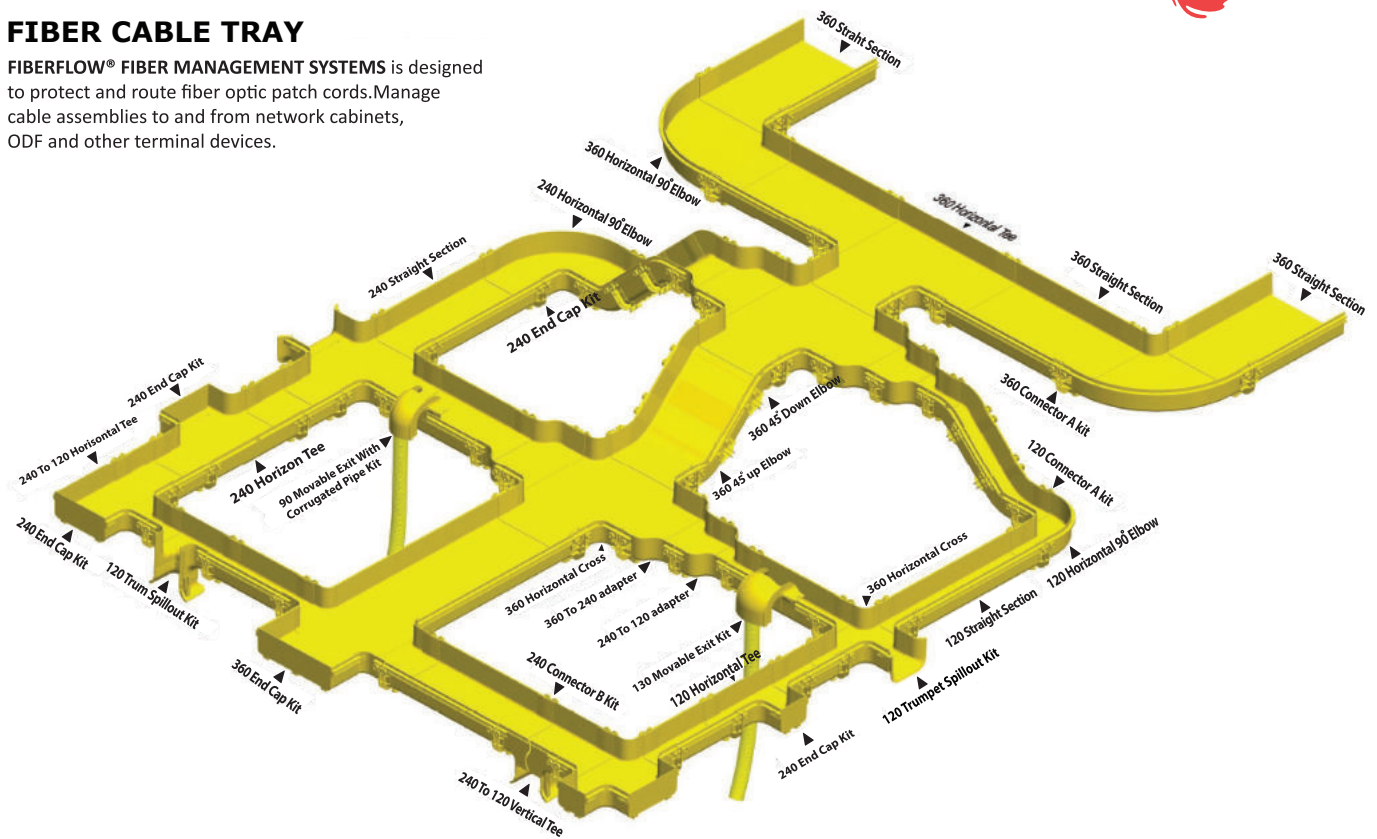

Fiber Cable Tray



Cover

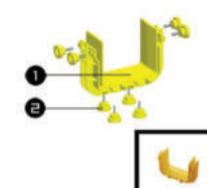

Connector



90° Horizontal Bend



90° Horizontal Bend cover



Horizontal Tee

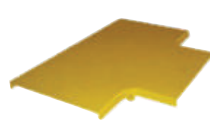

Horizontal Tee cover



Horizontal Cross

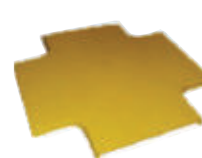

Horizontal Cross cover



45° External Riser



45° Vertical Outside bend cover

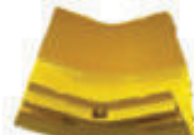

45° Vertical Inside bend

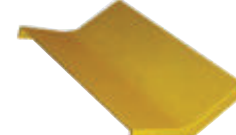

45° Vertical Inside (up) bend cover

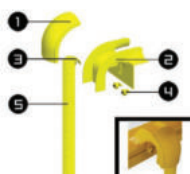

Movable Outer

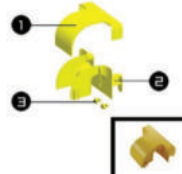

Large Movable Outer

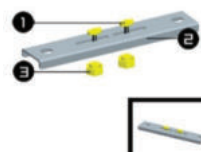

brace

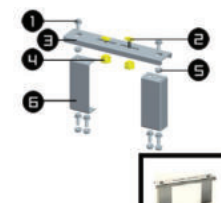

Cabinet top stand



# Wire Mesh/Fiber Tray Product



## Ordering Table

PRODUCT	PART NUMBER	DESCRIPTION	PRICE
WIRE MESH CABLE TRAY	CT-CM50-100-3000-5.0-EZ	Wire mesh cable tray : Height 50mm, Width 100mm, Length 3000mm, Diameter 3m/pc	350.00
	CT-CM50-200-3000-5.0-EZ	Wire mesh cable tray : Height 50mm, Width 200mm, Length 3000mm, Diameter 3m/pc	500.00
	CT-CM50-300-3000-5.0-EZ	Wire mesh cable tray : Height 50mm, Width 300mm, Length 3000mm, Diameter 3m/pc	600.00
	CT-CM50-400-3000-5.0-EZ	Wire mesh cable tray : Height 50mm, Width 400mm, Length 3000mm, Diameter 3m/pc	750.00
	CT-CM50-500-3000-5.0-EZ	Wire mesh cable tray : Height 50mm, Width 500mm, Length 3000mm, Diameter 3m/pc	900.00
	CT-CM50-100-3000-4.0-EZ	Wire mesh cable tray : Height 50mm, Width 100mm, Length 3000mm, Diameter 3m/pc	300.00
	CT-CM50-200-3000-4.0-EZ	Wire mesh cable tray : Height 50mm, Width 200mm, Length 3000mm, Diameter 3m/pc	326.00
	CT-CM50-300-3000-4.0-EZ	Wire mesh cable tray : Height 50mm, Width 300mm, Length 3000mm, Diameter 3m/pc	500.00
	CT-CM50-400-3000-4.0-EZ	Wire mesh cable tray : Height 50mm, Width 400mm, Length 3000mm, Diameter 3m/pc	550.00
	CT-CM50-500-3000-4.0-EZ	Wire mesh cable tray : Height 50mm, Width 500mm, Length 3000mm, Diameter 3m/pc	650.00
	CT-PJ-KK34-EZ-SET	Coupler	25.00
	CT-PJ-SBR-EZ-SET	Strength Bar	100.00
	CT-PJ-CSB-EZ-SET	Corner Strength Bar	200.00
	CT-PJ-ΩBR100-EZ	Ω BAR : 100mm, hang trays under ceiling ,Distance 1.5m	150.00
	CT-PJ-ΩBR200-EZ	Ω BAR : 200mm, hang trays under ceiling ,Distance 1.5m	220.00
	CT-PJ-ΩBR300-EZ	Ω BAR : 300mm, hang trays under ceiling ,Distance 1.5m	300.00
	CT-PJ-ΩBR400-EZ	Ω BAR : 400mm, hang trays under ceiling ,Distance 1.5m	350.00
	CT-PJ-ΩBR500-EZ	Ω BAR : 500mm, hang trays under ceiling ,Distance 1.5m	400.00
	CT-PJ-EFS100-EZ-SET	Cabinet Top Stand : 100mm	450.00
	CT-PJ-EFS200-EZ-SET	Cabinet Top Stand : 200mm	500.00
	CT-PJ-EFS300-EZ-SET	Cabinet Top Stand : 300mm	600.00
	CT-PJ-EFS400-EZ-SET	Cabinet Top Stand : 400mm	700.00
	CT-PJ-EFS500-EZ-SET	Cabinet Top Stand : 500mm	750.00
	CT-PJ-WBK100-EZ	Wall Bracket : 100mm, Wall mount of wire mesh cable tray.Distance 1.5m	130.00
	CT-PJ-WBK200-EZ	Wall Bracket : 200mm, Wall mount of wire mesh cable tray.Distance 1.5m	180.00
	CT-PJ-WBK300-EZ	Wall Bracket : 300mm, Wall mount of wire mesh cable tray.Distance 1.5m	280.00
	CT-PJ-WBK400-EZ	Wall Bracket : 400mm, Wall mount of wire mesh cable tray.Distance 1.5m	450.00
	CT-PJ-WBK500-EZ	Wall Bracket : 500mm, Wall mount of wire mesh cable tray.Distance 1.5m	550.00
	CT-PJ-CGD-EZ	Cable Guider	100.00
FIBER CABLE TRAY	CT-CF120-2000	120 Fiber Cable Tray ; 120mm width 100mm height: Yellow PVC material;2m/pc	1100.00
	CT-CF120-CVR-2000	120 Cover : 120mm width ; Yellow PVC material;2m/pc	500.00
	CT-CF120-CNT	120 Connector	420.00
	CT-CF120-ELB90-DB	120 90°Horizontal Bend	750.00
	CT-CF120-ELB90CVR-DB	120 90°Horizontal Bend cover	550.00
	CT-CF120-TEE-DB	120 Horizontal Tee	650.00
	CT-CF120-TEE-CVR-DB	120 Horizontal Tee cover	450.00
	CT-CF120-CRS-DB	120 Horizontal Cross	800.00
	CT-CF120-CRS-CVR-DB	120 Horizontal Cross cover	550.00
	CT-CF120-ERS45-DB	45°External Riser	500.00
	CT-CF120-ERS45-CVR-DB	120 45°Vertical Outside (down) bend cover	500.00
	CT-CF120-IRS-DB	120 45°Vertical Inside (up) bend	550.00
	CT-CF120-IRSCVR-DB	120 45°Vertical Inside (up) bend cover	500.00
	CT-CF240-2000	240 Fiber Cable Tray : 240mm width 100mm height; Yellow PVC material;2m/pc	1500.00
	CT-CF240-CVR-2000	240 Cover : 240mm width ; Yellow PVC material;2m/pc	700.00
	CT-CF240-CNT	240 Connector	500.00
	CT-CF240-ELB90-DB	240 90°Horizontal Bend	900.00
	CT-CF240-ELB90-CVR-DB	240 90°Horizontal Bend cover	800.00
	CT-CF240-TEE-DB	240 Horizontal Tee	850.00
	CT-CF240-TEE-CVR-DB	240 Horizontal Tee cover	600.00
	CT-CF240-CRS-DB	240 Horizontal Cross	1050.00
	CT-CF240-CRS-CVR-DB	240 Horizontal Cross cover	800.00
	CT-CF240-ERS45-DB	240 45°Vertical Outside (down) bend	700.00
	CT-CF240-ERS45-CVR-DB	240 45°Vertical Outside (down) bend cover	500.00
	CT-CF240-IRS45-DB	240 45°Vertical Inside (up) bend	700.00
	CT-CF240-IRS45-CVR-DB	240 45°Vertical Inside (up) bend cover	500.00
	CT-CF-OUT55-DB	Movable Outler	700.00
	CT-CF-OUT120-DB	Large Movable Outler	800.00
	CT-CF-BAR120	120 brace	220.00
	CT-CF-BAR240	240 brace	150.00
	CT-CF120-EFS	Cabinet top stand	550.00
	CT-CF240-EFS	Cabinet top stand	650.00

บริษัท โฟคคอมม (ประเทศไทย) จำกัด

12 ซอยสุขาภิบาล 5 ซอย 5 แยก 3 แขวงท่าแร้ง เขตบางเขน กรุงเทพฯ 10220 โทร. 063-391-5262 โทร. 02-557-6451 แฟกซ์. 02-557-6452

www.focomm-cabling.com

## UTP Terminate and Test Tool



Easy Crimping Hand Tool



Speed Termination Tool



Cable Stripper (RG59,6,11,213,UTP)

## Tester



T3innovation Giga test

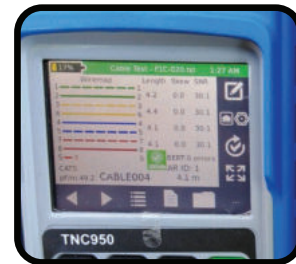
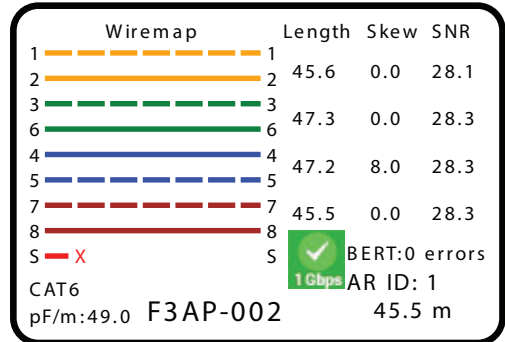
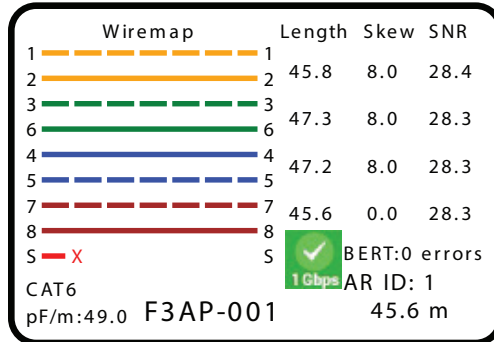

## Ordering Table

PRODUCT	PART NUMBER	DESCRIPTION	PRICE
UTP Terminate and Test	SR-UTP-U5	ค่า UTP Terminate หัวตัวผู้ CAT5E	50.00
	SR-UTP-U6	ค่า UTP Terminate หัวตัวผู้ CAT6	50.00
	SR-UTP-U6A	ค่า UTP Terminate หัวตัวผู้ CAT6A	60.00
	SR-UTPS	ค่า UTP Terminate หัวตัวผู้ แบบ Shield	70.00
	SR-UTMJ-U5	ค่า UTP Terminate หัวตัวเมีย CAT5E	70.00
	SR-UTMJ-U6	ค่า UTP Terminate หัวตัวเมีย CAT6	70.00
	SR-UTMJ-U6A	ค่า UTP Terminate หัวตัวเมีย CAT6A	80.00
	SR-UTPMJS	ค่า UTP Terminate หัวตัวผู้ แบบ Shield	100.00
	SR-UTPP-U5-24P	ค่า UTP Terminate Patch Panel CAT5E, 24 Ports	1,500.00
	SR-UTPP-U5-48P	ค่า UTP Terminate Patch Panel CAT5E, 48 Ports	3,000.00
	SR-UTPP-U6-24P	ค่า UTP Terminate Patch Panel CAT6, 24 Ports	1,800.00
	SR-UTPP-U6-48P	ค่า UTP Terminate Patch Panel CAT6, 48 Ports	3,500.00
	SR-UTPP-U6A-24P	ค่า UTP Terminate Patch Panel CAT6A, 24 Ports	3,500.00
	SR-UTPP-U5-24P	ค่า UTP Terminate Patch Panel Shield, 24 Ports	3,500.00
	SR-UT-24P	ค่าติดตั้ง พร้อม จัดสาย Patch Cord , 24 Port	1,500.00
	SR-UT-48P	ค่าติดตั้ง พร้อม จัดสาย Patch Cord , 48 Port	3,000.00
	SR-UTT-U5	ค่า test สาย UTP CAT5E	180.00
	SR-UTT-U6	ค่า test สาย UTP CAT6	180.00
	SR-UTT-U6A	ค่า test สาย UTP CAT6A	300.00

## Fiber Optic Splice and Test

### Tool



Fibre Optical Tool Kit 1

### Tester



### ความหมายของค่าต่างๆใน OTDR Report

#### Events on Fibers

เหตุการณ์ (Event) บนสายใยแก้วนำแสงจะเกิดจากการสูญเสีย(Loss) หรือการสะท้อน(Reflection) มากกว่าการกระจาย(Scattering) ที่เกิดจากรวดของสายใยแก้วที่ผลิต หลักการนี้จะใช้กับการเชื่อมต่อทุกแบบ รวมถึงความเสียหายที่เกิดจากการโค้งงอ(Bending) ,การแตก(Crack) หรือการขาด(Break) ของสายใยแก้วนำแสง

#### OTDR trace

จะแสดงผลของการวัดเป็นกราฟที่ทึบจนภาพ โดยแกนในแนวตั้งจะเป็นแกนกำลัง (Power axis) ส่วนแกนในแนวนอนเป็นแกนระยะทาง ในกราฟต่างๆเหล่านี้จะแสดงให้เห็นถึง trace ของเหตุการณ์ต่างๆ ที่มักเกิดขึ้นในการทดสอบ

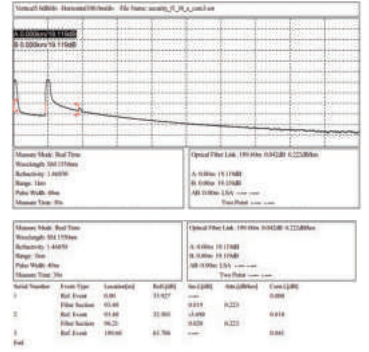

### การเชื่อมต่อสายใยแก้วนำแสง (Fusion splicer)

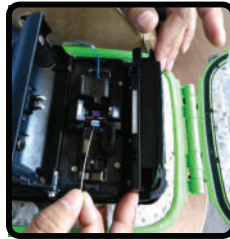
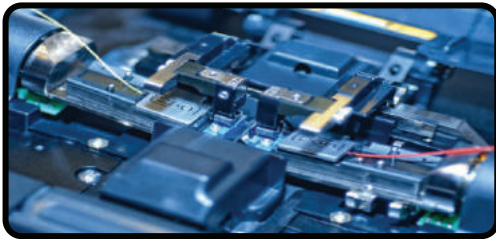

### Ordering Table

PRODUCT	PART NUMBER	DESCRIPTION	PRICE
Fiber Optic Splice and Test	SR-FST-01	ค่าเชื่อมต่อแบบ Splice Fiber Optic พร้อม OTDR test	400.00
	SR-FT-01	ค่าทดสอบสาย Fiber ทั้งแบบ Singlemode และ แบบ Multimode ด้วย OTDR แบบ 2 ความยาวคลื่น	300.00
	SR-FDU1U	ค่าติดตั้งถาด Fiber (FDU) ขนาด 1 U พร้อมจัดสาย	800.00
	SR-FDU2U	ค่าติดตั้งถาด Fiber (FDU) ขนาด 2 U พร้อมจัดสาย	1,200.00
	SR-FDU3U	ค่าติดตั้งถาด Fiber (FDU) ขนาด 3-4 U พร้อมจัดสาย	1,800.00
	SR-CCTV-OD	ค่าติดตั้งอุปกรณ์ Fiber Optic ภายในตู้ CCTV Outdoor แบบ Type A และ Type B	800.00
	SR-FSC-OD	ค่าติดตั้ง Fiber Optic Splice Clouse	2,000.00

### ค่าเดินทาง แผนภูมิระยะทางระหว่างจังหวัด (กม.)

กรุงเทพฯ	342	520	259	449	564	615	647	740	475	512	410	457	571	519	531	629	642	585	577
ชัยภูมิ	225	119	150	266	317	349	442	176	216	192	304	417	220	261	359	372	315	174	
เลย	344	206	152	202	311	404	278	318	417	462	552	283	391	489	437	445	106		
นครราชสีมา	190	305	356	378	481	216	235	151	198	312	260	272	370	383	326	351			
ขอนแก่น	115	166	205	298	73	113	200	256	347	77	184	282	243	238	161				
อุดรธานี	51	159	252	188	228	315	373	462	192	303	401	278	357	46					
หนองคาย	210	303	239	279	366	422	513	243	350	448	329	404	97						
สกลนคร	93	172	175	321	312	347	128	230	286	119	207	205							
นครพนม	265	268	414	350	332	221	215	271	104	192	298								
มหาสารคาม	40	145	177	274	44	115	213	210	165	234									
ร้อยเอ็ด	146	137	230	47	41	169	162	125	274										
บุรีรัมย์	50	155	184	191	216	302	245	316											
สุรินทร์	105	184	135	166	246	189	419												
ศรีสะเกษ	279	159	61	228	136	508													
กาฬสินธุ์	118	216	166	172	238														
ยโสธร	89	111	54	349															
อุบลราชธานี	167	75	447																
มุกดาหาร	88	320																	
อำนาจเจริญ	324																		
หนองบัวลำภู																			

อัตราค่าบริการ 5.-/กิโลเมตร

ตัวอย่าง กรุงเทพฯ - บุรีรัมย์ 410 กิโลเมตร x 5.- = 2050.-





# IDEA



## Fiber Optic Solution

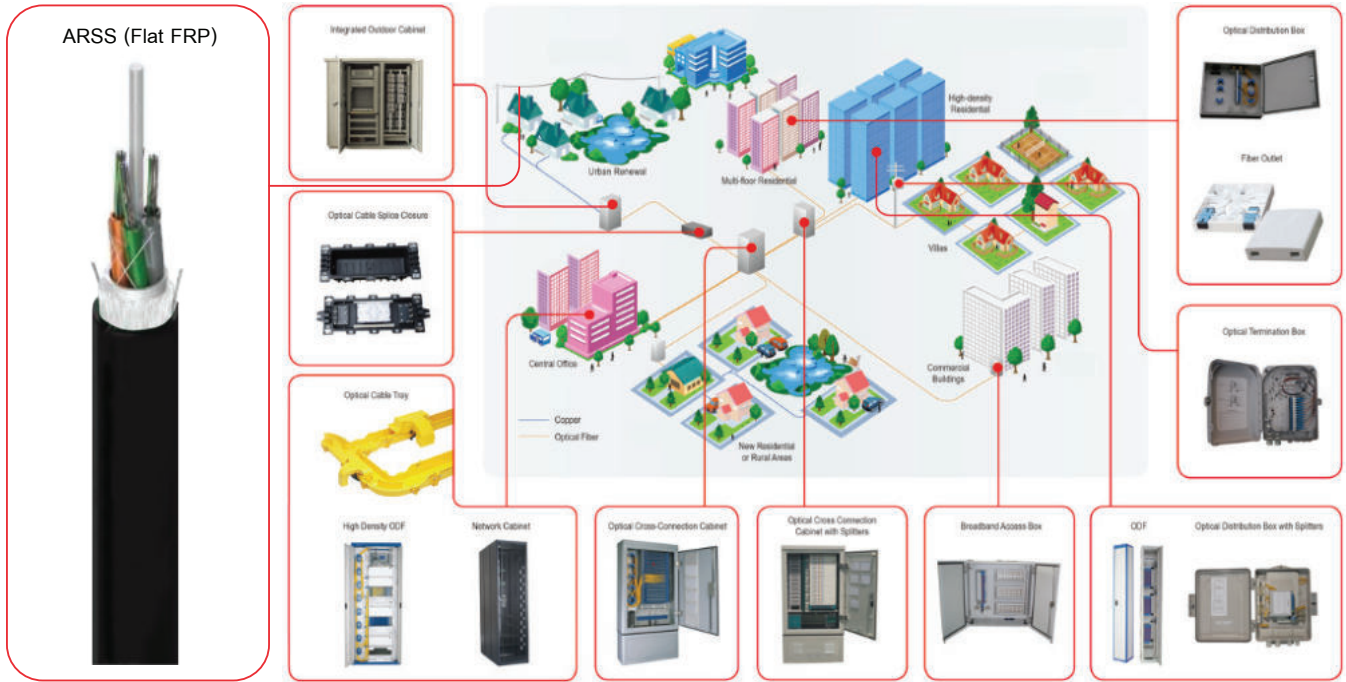

### Product Focomm

#### Fiber Cable ชนิด ARSS (Flat FRP)

- สายไฟเบอร์ออปติกแบบ Anti-Rodent Self Support (ARSS) เป็นสายไฟเบอร์ออปติกที่มีเกราะป้องกันสัตว์กัดแทะ ทนต่อแรงดึง มีคุณสมบัติครอบคลุมที่ตรงกับข้อกำหนดทั่วไป ใช้เป็นสายเคเบิลสื่อสารในระบบส่งกำลังทางแสง ตามมาตรฐานพาดสายสื่อสารโดยใช้ FLAT FRP Amored Cable
- Flat FRP ถูกออกแบบมาเพื่อใช้เป็นเกราะฉนวนในสายเคเบิลที่มีความทนทานสูงเช่นสายเคเบิลที่ทนต่อการกัดแทะ, สายเคเบิลที่ทนต่อการกัดแทะ, สายเคเบิลฝังดินโดยตรง, สายอากาศทนกระสุน ฯลฯ เหมาะที่สุดสำหรับป้องกันLoostube, และโดยทั่วไปจะใช้เป็นอุปกรณ์เสริมในสายเคเบิลใยแก้วนำแสง โดยทั่วไปแล้วจะฝังอยู่ในแจ็คเก็ตหรือติดอยู่เหนือแกนเคเบิลและสายเคเบิลที่ผลิตด้วยจะมีขนาดเส้นผ่าศูนย์กลางที่ต่ำกว่าและน้ำหนักเบา

#### F.O. Splice Closure, In-Line Type

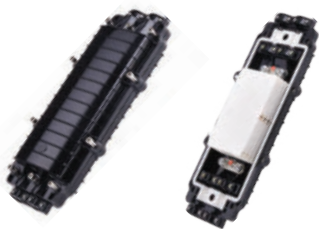

Closure Outdoor 48, 96Cores / 2, 4 Tray(24Fiber) เข้า 2 ออก 2 สำหรับใช้เป็นตัวทักจุดต่อสายไฟเบอร์ออปติก หรือจุดสไปรท์สายไฟเบอร์ออปติก รองรับสายไฟเบอร์ออปติก ขนาด 12 Core หรือ 6 Core 2 เส้น ตัวอุปกรณ์ผลิตด้วยวัสดุ PE อย่างดี ออกแบบมาให้มีอายุการใช้งานน้ำโดยรอบ สามารถป้องกันน้ำเข้าได้ 100% แม้จะถอดเข้าออกหลายครั้ง

#### Optical Fiber Distribution Frame (144-576)



เฟรมนี้ทำจากเหล็กคุณภาพสูงและโลหะผสมอลูมิเนียมที่ผ่านการปรับสภาพแล้วผ่านการชุบด้วยกัลวาไนซ์ การเกิดออกซิเดชันและการขีดพื้นพลาสติกด้วยไฟฟ้าสถิต กรอบมีโครงสร้างที่แข็งแกร่งและรูปลักษณะที่นำพาใจ

- โครงสร้างที่ปิดสนิทด้วยข้อดีของประสิทธิภาพที่ดีของการป้องกันฝุ่นที่ขึ้นขอบและลักษณะเรียบร้อย
- มีพื้นที่เพียงพอสำหรับการกระจายเส้นใยและพื้นที่เก็บข้อมูลและง่ายต่อการติดตั้งและใช้งาน
- ดำเนินการอย่างเต็มที่ด้านหน้าสะดวกสำหรับการบำรุงรักษา
- รอยต่อและการกระจายจะถูกแยกและกระจายอย่างสม่ำเสมอบนด้านบนและด้านล่างของกรอบโครงสร้างที่กะทัดรัดและชั้นที่แตกต่างเพื่อการจัดการที่สะดวก
- ใช้แผ่นประกอบสไลด์จานร่อน (UFO type) สามารถถือได้ถึง 48 ถาดในหนึ่งเฟรม
- รัศมีความโค้ง 40 มม.
- เฟรมนี้เหมาะสำหรับทั้งสายเคเบิลมัดทั่วไปและสายเคเบิลชนิดribbon
- ฝาครอบตัวยึดสายเคเบิลที่เชื่อถือได้และอุปกรณ์ป้องกันดินให้

### มาตรฐานการพาดสายสื่อสาร

- การขออนุญาต ให้รวมถึงกรณีดังต่อไปนี้
  - การพาดสายและหรือติดตั้งอุปกรณ์สื่อสารโทรคมนาคมใหม่
  - การพาดสายและหรือติดตั้งอุปกรณ์สื่อสารโทรคมนาคมเพิ่มเติม
  - ต้องระบุขนาดเส้นผ่านศูนย์กลางรวมของสายที่ติดตั้งอยู่แล้วมีขนาดเท่าใด และหรือจำนวนอุปกรณ์ที่ติดตั้งอยู่แล้วมีจำนวนเท่าใด
  - การร้อยสายและหรืออุปกรณ์สื่อสารโทรคมนาคมเดิมออก และพาดสายและหรือติดตั้งอุปกรณ์สื่อสารโทรคมนาคมใหม่ทดแทน
  - การร้อยสายและหรืออุปกรณ์สื่อสารโทรคมนาคมที่ได้รับอนุญาตไปแล้ว
  - การพาดสายสื่อสารโทรคมนาคม ตั้งแต่วันที่ ๑ มกราคม ๒๕๖๑ เป็นต้นไป
- สายสะพาน (Messenger Wire) ของสายสื่อสารโทรคมนาคมชนิดตัวนำสายใยแก้วนำแสง (Optical Fiber) ต้องเป็นอลิโหะเท่านั้น

## FTTH Solution

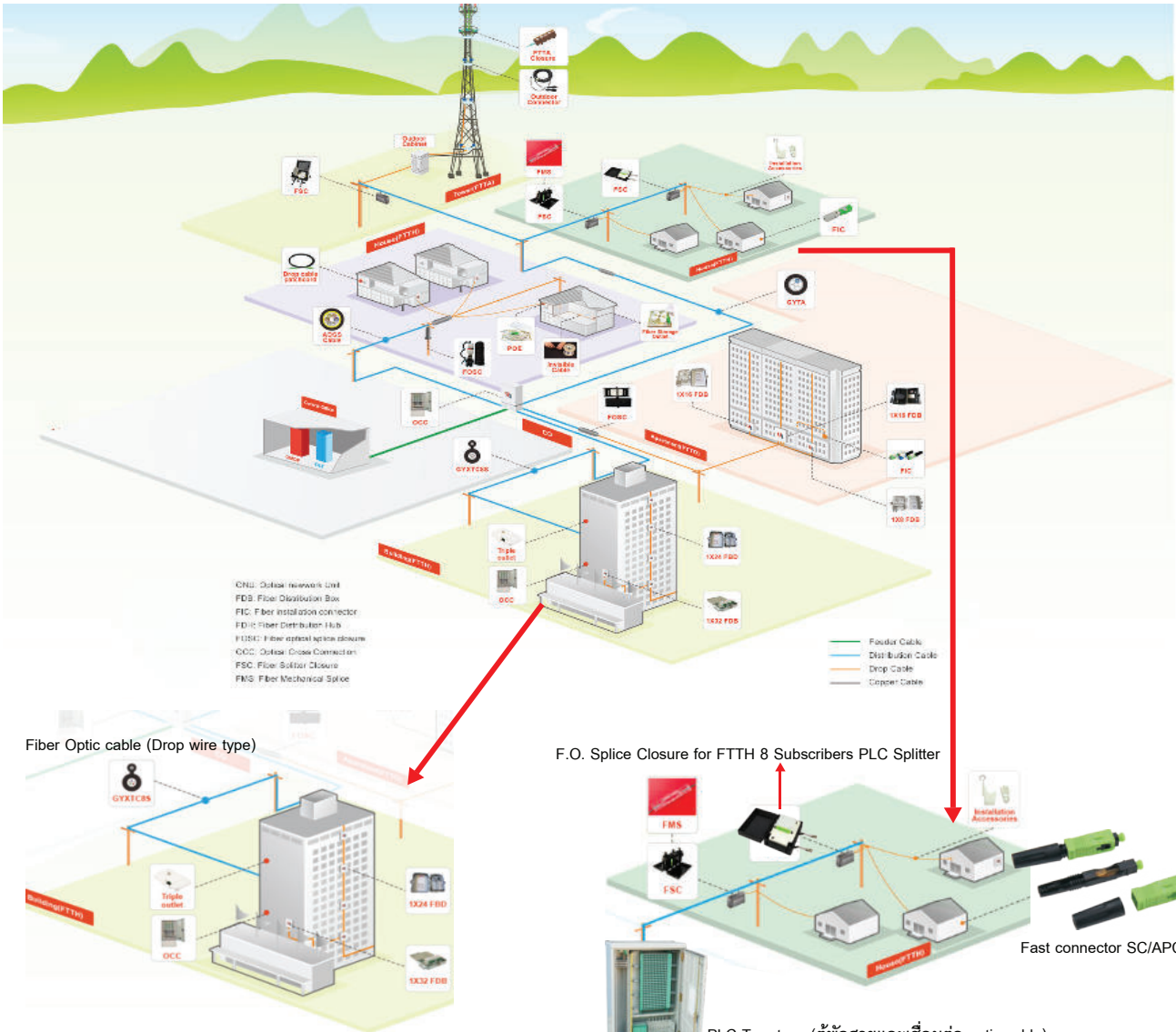

### Product Focomm

#### Fast connector SC/APC

เป็นหัว Connector ของ Fiber Optic หัวต่อชนิดนี้ถูกออกแบบโดย AT&T สำหรับการเชื่อมต่อ Fiber Optic ภายในอาคารสำนักงาน ซึ่งเครือข่ายแลนชนิดนี้เหมาะสำหรับงานที่ต้องการถอดเปลี่ยน Connector อย่างรวดเร็ว โดยไม่สนใจความแน่นหนาของ Connector

APC (Angled Physical Contact) การติดต่อทางกายภาพเชิงมุม หน้าปลายถูกดึงไปยังมุม 8 องศา ซึ่งเป็นมุมเอียงเพื่อลดการสะท้อน APC สามารถเชื่อมต่อกับ APC ได้เท่านั้น เนื่องจากโครงสร้างของ APC แตกต่างไปจาก UPC หากเชื่อมต่อทั้งสองหัวต่อกับหน้าแปลนปลายด้านใดแล้วนำแสงของหัวต่อจะได้รับความเสียหาย

#### Fiber Optic cable (Drop wire type)

- ออกแบบพิเศษสำหรับใช้ร่วมกับกลางแจ้งและในร่ม
- ก่อสร้างอิเล็กทรอนิกส์ทั้งหมด
- โยแก้วนำแสงแบบหลายโหมดหรือโหมดเดียว
- ATM, FDDI, CATV, FTTH, การสื่อสาร

#### PLC Tray type (ตู้พักสายและเชื่อมต่อ optic cable)

- วัสดุ: SMC (แม่พิมพ์โกลด์พลาสติกเสริมด้วยแผ่น โยแก้วโพลีเอสเตอร์โพลีเอสเตอร์แบบไม่อมตัว) ซึ่งเกิดขึ้นหลังจากการขึ้นรูปที่อุณหภูมิสูงและการขึ้นรูปด้วยแรงดันสูง
- เกรด IP กันน้ำ: IP65 o
- อุณหภูมิสิ่งแวดล้อม: -40 C ~ +60 C
- การใช้ชีวิต: > 30 ปี

#### บริษัท โฟคอมม์ (ประเทศไทย) จำกัด

12 ซอยสุขาภิบาล 5 ซอย 5 แยก 3 แขวงท่าแร้ง เขตบางเขน กรุงเทพฯ 10220 โทร. 063-391-5262 โทร. 02-557-6451 แฟกซ์. 02-557-6452

www.focomm-cabling.com

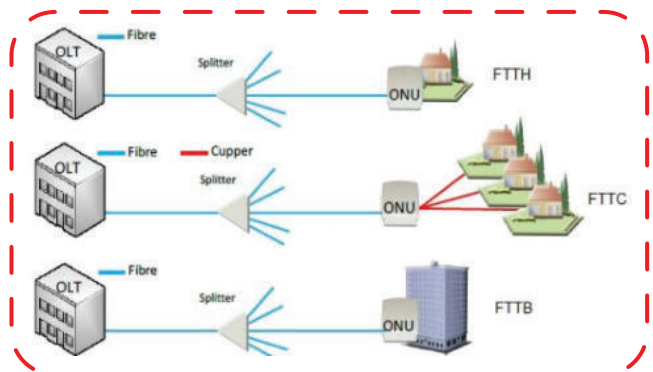

#### F.O. Splice Closure for FTTH 8 Subscribers PLC Splitter

- เป็นกล่องพักและ splice core optic cable เพื่อแยกสาย แยกcore optic ไปจุดต่างๆต่อไป
- ทำจากพลาสติกลักษณะที่สมบูรณ์แบบ
- การออกแบบแยกโมดูลก็สามารถติดตั้งแยก 1x8, 1x4, 1x2 แยก
- เปิดและปิดง่ายไม่ต้องใช้เครื่องมือใด ๆ
- การออกแบบเส้นทางใยที่สมบูรณ์แบบเพื่อให้แน่ใจว่ารัศมีการโค้งของเส้นใย
- การออกแบบพิเศษสำหรับการกันน้ำสามารถเป็น IP 55



## MPO Data Center Solution

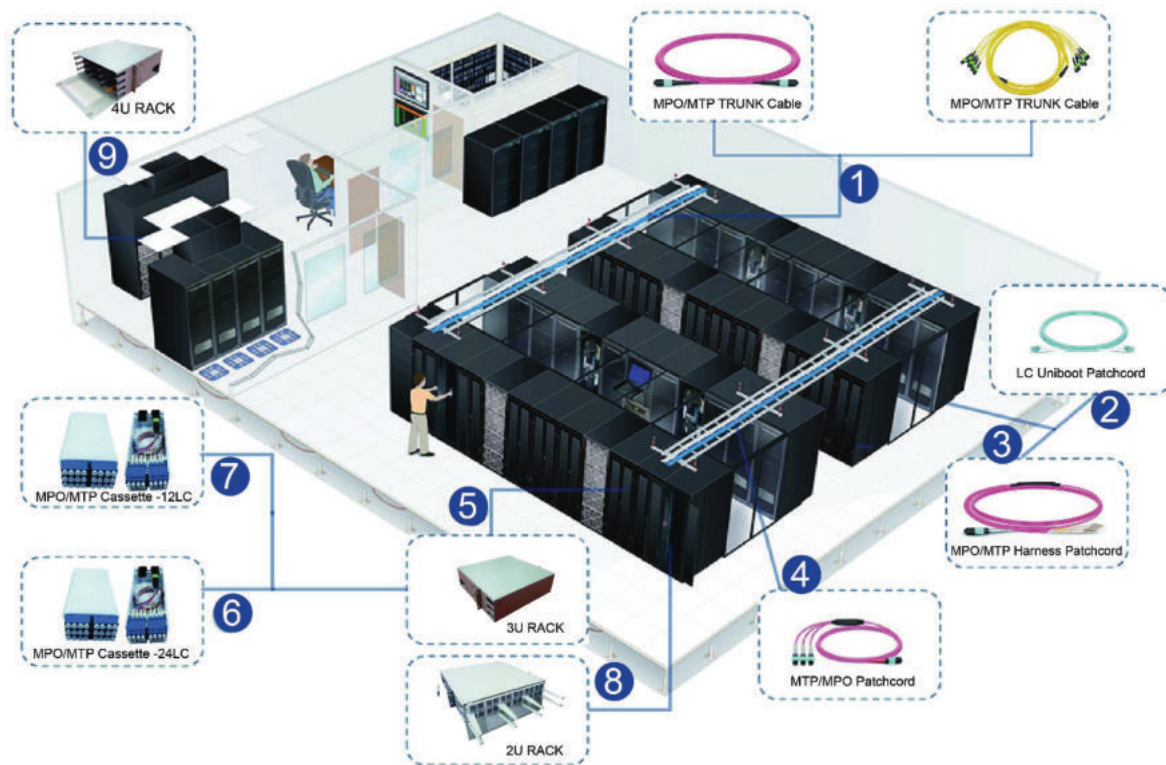

### Product Focomm

#### MPO (Multi-fiber Pull Off)

เป็นตัวเชื่อมต่อไฟเบอร์ออปติกแบบ multi-core รุ่นแรกที่ออกแบบโดย บริษัท สื่อสาร NTT ของญี่ปุ่น ตอนนั้นมันเป็นชื่อของตัวเชื่อมต่อแบบมัลติคอร์ที่ผลิตโดย บริษัท หลายแห่ง และ MTP ซึ่งเป็นแบรนด์ที่จดทะเบียนโดย บริษัท USConec ในสหรัฐอเมริกาจนถึงชนิดที่ไม่เหมือนใครของตัวเชื่อมต่อ MPO ที่ผลิต

#### ตัวเชื่อมต่อ MPO คืออะไร

MPO เป็นตัวย่อของ "Multi-fiber Pull Off" หรือ "มัลติไฟเบอร์แบบดึงออก" ปลั๊กของข้อต่อมีแกนมากกว่า 1 แกนและติดอยู่ในลักษณะเชิงกล มีการออกแบบ MPO หลายประเภทในตลาด ประสิทธิภาพและค่าใช้จ่ายของผลิตภัณฑ์การเชื่อมต่อประเภทต่าง ๆ นั้นแตกต่างกันมาก ลักษณะของผลิตภัณฑ์บางประเภททำให้ประสิทธิภาพโดดเด่นยิ่งขึ้น ตัวเชื่อมต่อ MPO บางตัวสามารถจับคู่ผลิตภัณฑ์แบรนด์ต่าง ๆ ได้ แต่ก็ไม่สามารถทำได้และความเข้ากันได้ขึ้นอยู่กับว่าการออกแบบตัวเชื่อมต่อที่ใกล้เคียงกับผลิตภัณฑ์มาตรฐานอย่างไร สำหรับคำจำกัดความที่สมบูรณ์ของตัวเชื่อมต่อ MPO ให้ดูที่การใช้ IEC-61754-7 และ EIA / TIA-604-5 (aka FOCIS 5)

#### MTP คืออะไร ข้อต่อไฟเบอร์ออปติก?

ตัวเชื่อมต่อ MTP เป็นตัวเชื่อมต่อ MPO ประสิทธิภาพสูงที่มีนวัตกรรมการออกแบบหลายแบบ เมื่อเปรียบเทียบกับตัวเชื่อมต่อ MPO ทั่วไปตัวเชื่อมต่อไฟเบอร์ออปติก MTP ได้รับการปรับปรุงในด้านคุณสมบัติเชิงแสงและเชิงกล ตัวเชื่อมต่อ MTP เป็นไปตามมาตรฐานวิชาชีพของตัวเชื่อมต่อ MPO ทั้งหมดรวมถึง EIA / TIA-604-5 FOCIS 5 และ IEC-61754-7

ตัวเชื่อมต่อ MPO เป็นตัวเชื่อมต่อ MTP MTP ซึ่งเป็นไปตามมาตรฐานอุตสาหกรรม ซึ่งหมายความว่าเมื่อได้ที่จะใช้ตัวเชื่อมต่อ MTP เพื่อแทนที่ตัวเชื่อมต่อ MPO เพื่อให้ได้ประสิทธิภาพที่ดีขึ้น ตัวเชื่อมต่อ MPO ส่วนใหญ่ที่ออกแบบมากับตัวเก่าที่มีข้อ จำกัด ด้านประสิทธิภาพและไม่สามารถให้ประสิทธิภาพสูงเช่นเดียวกับตัวเชื่อมต่อไฟเบอร์ MTP

Reach & Bandwidth by MM Fiber Type

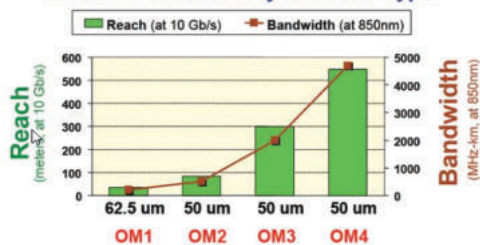

Fiber Type (ISO Grade)

ประเภทไฟเบอร์และการเข้ารหัส	แบนด์วิดท์ * ยาว ผลิตภัณฑ์ (MHz * กม. หรือ GHz * m)	ระยะทาง 10GBASE-SR (เมตร)	40GBASE-SR4 และ 100GBASE-SR10 ระยะทาง (เมตร)
OM1	160-200	33	N / A
OM2	400-500	82	N / A
OM3	2000	300	100
OM4	4700	400	150

เส้นใยแบบหลายเส้นจะถูกระบุโดย OM ("โหนดออปติคัล") ตามที่กำหนดไว้ในมาตรฐาน ISO / IEC 11801

- OM1 สำหรับสายสัญญาณที่มีแบนด์วิดท์ OFL (bandwidth overfilled launch) ที่ 200/500 MHz \* ที่ 850 / 1300nm (โดยทั่วไปคือเส้นใย 62.5 / 125um)
- OM2 สำหรับไฟเบอร์ที่มีแบนด์วิดท์ 500/500 MHz \* กม. OFL ที่ 850 / 1300nm (โดยปกติจะเป็นไฟเบอร์ 50 / 125um)
- OM3 สำหรับเส้นใย 50um แบบเลเซอร์ซึ่งมีแบนด์วิดท์กิริยาตอบสนองความถี่ 2000 MHz \* กม. (EMB หรือที่เรียกว่าแบนด์วิดท์ของเลเซอร์) ออกแบบมาสำหรับการส่งผ่าน 10 Gb / s
- OM4 สำหรับไฟเบอร์ออปติก 50um ที่มีเลเซอร์ที่มีแบนด์วิดท์ EMB 4700 MHz \* กม. ที่ออกแบบมาสำหรับการส่งผ่าน 10 Gb / s, 40 Gb / s และ 100 Gb / s การเข้าถึงและแบนด์วิดท์ทางกิริยาช่วย

## UTP Solution

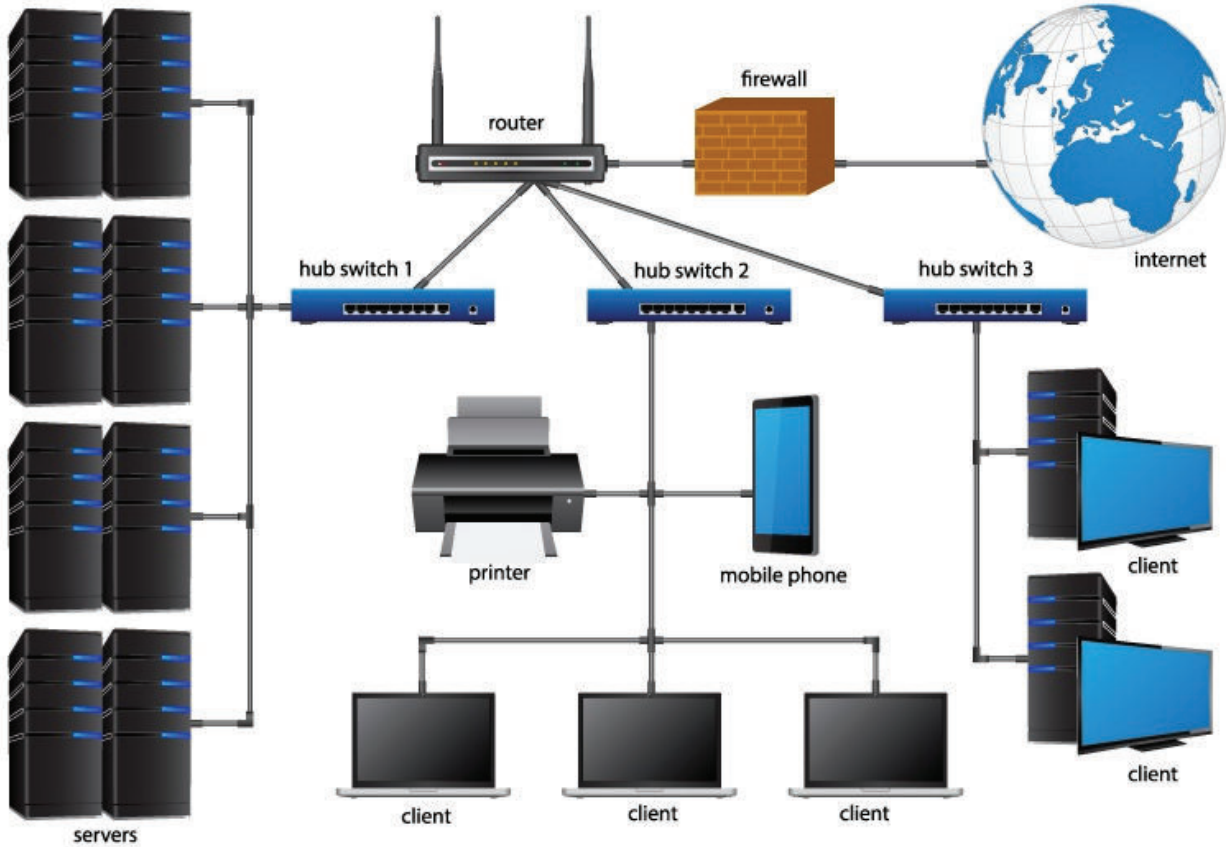

### CAT 6 A Cable

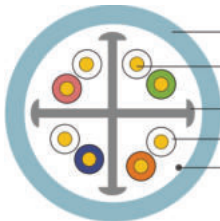

เป็นสาย FTP หรือสายแลนที่มีการหุ้มด้วย Foil เพื่อกันสัญญาณรบกวนจากภายนอก สายสัญญาณชนิดนี้ เหมาะกับการใช้งานภายในอาคารทั่วไป และนิยมใช้เดินสายเป็น Backbone หรือสาย main ที่ใช้ในการเชื่อมต่อที่เร็วขึ้น จาก router ไปหา switch เพื่อกระจายไปที่ เครื่องลูกข่ายต่างๆ โดยการติดตั้งจะมีขนาด(Diameter) ของสายที่ใหญ่กว่าสาย Cat.5e และ cat.6 ธรรมดาพอสมควร เพราะหุ้มด้วย Foil เพื่อป้องกันสัญญาณรบกวน จึงจะต้องเพิ่มขนาดของ ท่อร้อยสายให้มีขนาดใหญ่ขึ้น ส่วนการติดตั้งจะเดินแบบร้อยท่อ ร้อยเหล็ก หรือใส่รางพลาสติกก็ได้ ขึ้นอยู่กับลักษณะของพื้นที่และสถานที่นั้นๆ

**คุณสมบัติสาย :** สายสัญญาณ Cat6A จะมีขนาดแกนทองแดง ที่ 23AWG (0.65 Sqmm)จำนวน 8 เส้น 4 คู่(Pair) ที่ใกล้เคียงกัน เท่ากันกับ Cat.6 ทั่วไปและความเร็วในการส่งผ่านข้อมูลที่ 10 Gigabit ตามมาตรฐาน (2009) ANSI/TIA-568-C.1. Category 6A และ IEEE 802.3an 10GBASE-T Standard, สามารถใช้งานได้เต็มระยะของความยาวสูงสุดตามมาตรฐานที่ 100 เมตร(328 ฟุต) (มาตรฐาน TIA-EIA-568) ที่ความเร็ว 10Gigabit แต่สาย Cat6 ธรรมดาสามารถใช้งานความเร็วที่ 10Gigabit ที่ระยะแค่เพียง 55 เมตรเท่านั้น จึงนิยมใช้เป็นสาย backbone ในการเชื่อมต่อระบบเครือข่ายคอมพิวเตอร์เน็ตเวิร์คทั่วไป โดยที่มีสัญญาณความถี่มาตรฐานในการส่งสัญญาณอยู่ที่ 500 MHz (อีกความถี่ที่ 600MHz(บางยี่ห้อ)), มีการส่งผ่านข้อมูลอยู่ที่ 10, 100, 1000 และ 10Gbit/s โดยจะอิงกับมาตรฐาน 10BASE-T, 100BASE-T (Fast Ethernet), 1000BASE-T(Gigabit Ethernet) และ 10GBASE-T (10Gbit/s Ethernet) ในการส่งผ่านข้อมูลระหว่างสายสัญญาณซึ่งจะมีสถาบันรองรับเป็นการกำหนดมาตรฐานขึ้นมา (Communication Standard) เช่น IEEE เป็นต้น

### CAT 7 to Features (เกร็ดความรู้)

มาเริ่มกันที่ข้อเหมือนกันก่อนเลยนะค่ะ เรื่องของระยะทางการเดินสาย UTP Cable ไม่ว่าจะป็นชนิดใดก็ตาม จะมีความสามารถในการรองรับที่ระยะทางที่ไม่เกิน 100 เมตรเท่านั้น ส่วนข้อที่แตกต่างคือ ความเร็วในการส่งผ่านข้อมูล (Speed) และความกว้างของช่องสัญญาณ (Bandwidth) ที่รองรับข้อมูลมากกว่าหรือน้อยกว่าแตกต่างกันไปตามชนิดของสายนั้นๆ คล้ายกันกับถนน ยังมีหลายเลนมากเท่าไร ก็จะสามารถวิ่งได้มากขึ้นเท่านั้นค่ะ

**รายละเอียดของ Speed และ Bandwidth เป็นไปตามข้างล่างนี้ค่ะ**

- Cat5e Cable @ SPEED จะมี Speed สูงสุดอยู่ที่ 1Gbps ที่ Bandwidth 100MHz
- Cat6 Cable @ SPEED จะมี Speed สูงสุดอยู่ที่ 1Gbps ที่ Bandwidth 250MHz
- Cat6A Cable @ SPEED จะมี Speed สูงสุดอยู่ที่ 10Gbps ที่ Bandwidth 500MHz
- Cat7 Cable @ SPEED จะมี Speed สูงสุดอยู่ที่ 10Gbps ที่ Bandwidth 600MHz

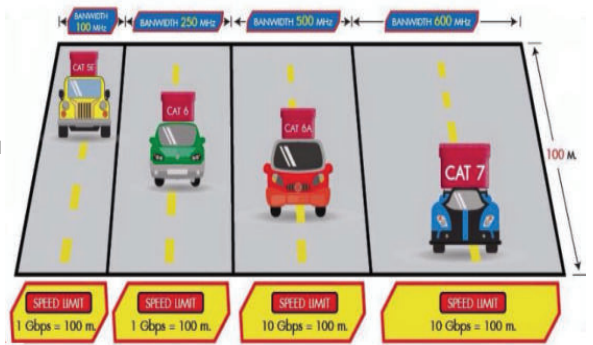





### Product Focomm

#### SFP (Small Form Pluggable Module)

SFP (Small Form Pluggable Module) หน้าที่หลักๆ ใส่งข้อมูลสัญญาณ เหมือนหัว RJ45 แต่ SFP รับส่งข้อมูลด้วยแสง ผ่านสาย Fiber Optic ส่วนใหญ่แล้ว Switch รุ่นใหม่ จะใช้ตัว Module

Gigabit แบบนี้แทนเพราะเล็กกว่าและกินไฟน้อยกว่าด้วยพุดง่าย ๆ ต่างกันที่รูปร่างและขนาดซึ่ง SFP ก็คือ mini-GBIC นั่นเองลักษณะการท งานเหมือนกันมาตรฐานก็จะมีเหมือนกันเช่น SFP 1000BASE-SX, SFP 1000BASE-LX, SFP 1000BASE-LH

ซึ่งการใช้งานสามารถเลือกใช้ Fiber Optic ให้เหมาะสมกับชนิดและระยะทางดังต่อไปนี้

- |                      |            |  |                  |                      |
|----------------------|------------|--|------------------|----------------------|
| 1. SFP 1000BASE-SX   | ใช้ร่วมกับ | Fiber optic ชนิด Multi mode (GLC-SX-MM)    | จะใช้งานได้ดีที่ | ระยะทาง 220-550 เมตร |
| 2. SFP 1000BASE-LX   | หากใช้กับ  | Fiber optic ชนิด Multi mode (GLC-LX-MM)    | จะใช้งานได้ดีที่ | ระยะทาง 550 เมตร     |
| 3. SFP 1000BASE-LX   | หากใช้กับ  | Fiber optic ชนิด Single mode (GLC-LX-SM)   | จะใช้งานได้ดีที่ | ระยะทาง 5 กิโลเมตร   |
| 4. SFP 1000BASE-LH   | หากใช้กับ  | Fiber optic ชนิด Single mode (GLC-LH-SM)   | จะใช้งานได้ดีที่ | ระยะทาง 5 กิโลเมตร   |
| 5. SFP 1000BASE-LX10 | ใช้กับ     | Fiber optic ชนิด Single mode (GLC-LX10-SM) | จะใช้งานได้ดีที่ | ระยะทาง 10 กิโลเมตร  |
| 6. SFP 1000BASE-ZX   | ใช้กับ     | Fiber optic ชนิด Single mode (GLC-ZX-SM)   | จะใช้งานได้ดีที่ | ระยะทาง 70 กิโลเมตร  |

40G QSFP+



**DWDM**  
DWDM wavelength (nm)

**CWDM**  
CWDM wavelengths (nm)

Specifications/Features	CWDM	DWDM
Full form	Coarse Wavelength Division Multiplexing WDM system having less than 8 active wavelengths per optical fiber	Dense Wavelength Division Multiplexing WDM system having more than 8 active wavelengths per optical fiber
characteristic	Defined by wavelengths	Defined by frequencies
capacity	lower	higher
cost	low	high
Distance	short range communication	long range communication
Frequencies	uses wide range frequencies	uses narrow range frequencies
Wavelength spacing	more	less, hence can pack 40+ channels compare to CWDM in the same frequency range
Amplification	light signal is not amplified here	light signal amplification can be used here
Drift	Wavelength drift is possible	Precision lasers are needed to keep channels on the target.
Spectrum utilization	Breaks the spectrum into big chunks	dices the spectrum into small pieces.
No. of active wavelengths per fiber	Fewer than 8	More than 8

#### SFP (Small Form Pluggable Module)

คุณรู้ทำไมบางสัญญาณแสงที่มีสีสั้น วันนี้จะแบ่งปันข้อมูลเกี่ยวกับโมดูลเหล่านี้ SFP มีสีสั้น

SFP โมดูลมีสีสั้นเรียกว่าความยาวคลื่นส่วนมัลติเพล็กซ์แบบ (WDM) SFP โมดูล

WDM SFP จะแบ่งออกเป็นสองประเภท: CWDM SFP DWDM SFP

DWDM SFP (Dense Wavelength Division Multiplexing) คือ เทคโนโลยีที่ใช้ในสาย Fiber Optic อีกรูปแบบหนึ่งซึ่งเป็นการสื่อสารด้วยแสงที่สามารถรองรับปริมาณข้อมูลได้เพียงพอซึ่งวิธีนี้จะทำให้สามารถ Multiplex เพื่อให้ได้มาซึ่ง Channel จำนวนมาก ทำให้ไม่เกิดปัญหาคอขวดตามมา

**สีแสดงความยาวคลื่นที่แตกต่างกัน วันนี้เราแนะนำส่วนใหญ่ CWDM SFP CWDM**

CWDM SFP เป็นชนิดของopticalพร้อมด้วยเทคโนโลยี CWDM การแก้ปัญหาเชื่อมต่อเครือข่ายที่มีประสิทธิภาพสูง และประหยัด ใช้แพร่หลายในมหาวิทยาลัย ศูนย์ข้อมูล และ Gigabit Ethernet และเส้นใยช่อง (FC) ในเครือข่ายบริเวณนครหลวงและเครือข่ายอื่นๆได้

**CWDM SFP มีความยาวคลื่นที่แตกต่างกัน**

ทั่วไป CWDM SFP มีแปดช่วงความยาวคลื่นตั้งแต่ 1470nm ถึง 1610nm เพื่อกำหนดความยาวคลื่นของการใช้การแม่ปช่อง Gigabit Ethernet ดีกว่า เมื่อใช้ ดังนั้นเราจะใช้สีที่แตกต่างกันเพื่อจับคู่ และแยก SFP CWDM เหล่านี้ จึงมี SFP สีต่าง ๆ ที่มีการใช้งานที่แตกต่างกัน ใช้ Cisco เป็นตัวอย่าง รายการต่อไปนี้ความยาวคลื่น และสีของ SFP CWDM แตกต่างกัน

## Solution Surge Protection

### Surge Protection Solution

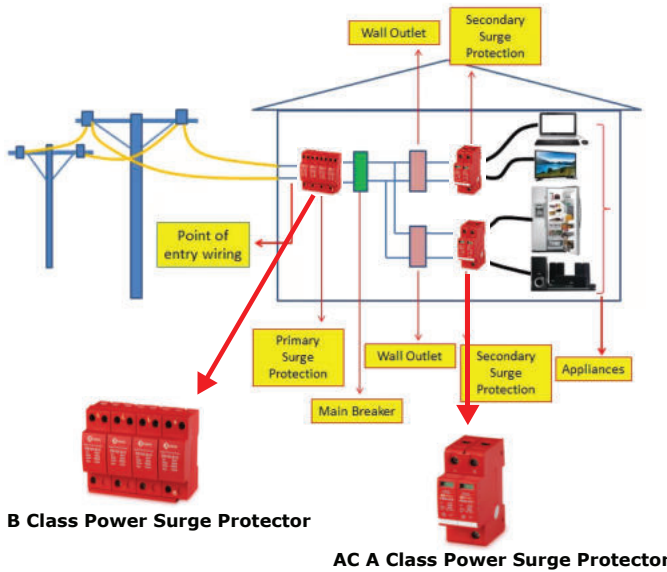

### POE Surge Protection Solution

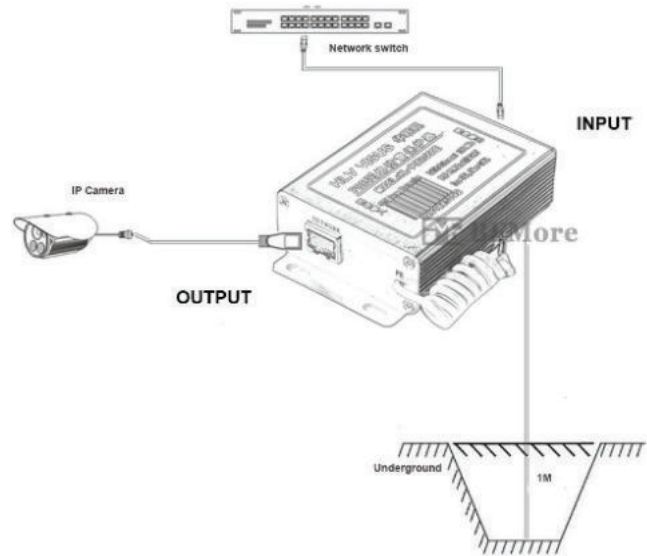

## Product Focomm

### Surge Protector

#### ความหมายของ Surge Protector

ไม่ว่าจะเป็นคำว่า Surge Protection Device (SPD), Surge Suppression Equipment (SSE) หรือ Transient Voltage Surge Suppressor (TVSS) จะหมายถึงอุปกรณ์ชนิดเดียวกันคือ Surge Protector หรือ "อุปกรณ์ป้องกันไฟกระชากแรงดันสูงชั่วขณะ"

อุปกรณ์ป้องกันไฟกระชากแรงดันสูงชั่วขณะ เป็นอุปกรณ์ที่ช่วยลดแรงดันไฟฟ้าและกระแสไฟฟ้าที่สูงขึ้นอย่างรวดเร็วในช่วงเวลาสั้นๆ ได้ ซึ่งพลังงานที่สูงมากเช่นนี้สามารถสร้างความเสียหายต่ออุปกรณ์ไฟฟ้า, อุปกรณ์อิเล็กทรอนิกส์ และเครื่องมือ-เครื่องใช้ในการควบคุมการประมวลผล ฯลฯ

**อุปกรณ์ป้องกันไฟกระชากแรงดันสูงชั่วขณะ มีหน้าที่หลักอยู่ 2 ประการ คือ**

1. สร้างบริเวณหนึ่งให้มีความต้านทานต่ำ เพื่อให้แรงดันไฟฟ้าและกระแสไฟฟ้าที่สูงขึ้นกลับอยู่ในสภาวะปกติ ได้แก่ สายดิน
2. ทำการเหนี่ยวนำแรงดันไฟฟ้าและกระแสไฟฟ้าที่สูงเกินไปยังบริเวณที่สร้างขึ้น (สายดิน) เพื่อป้องกันความเสียหายที่สามารถเกิดขึ้นได้

### Camera Surge Protectors

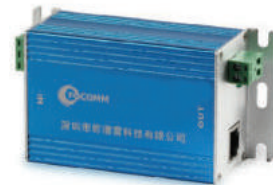

SP-SN-2

#### คุณสมบัติ

- LAN Port 1000Mbps
- เครื่องขยายและสายไฟทำการป้องกัน 2 in 1
- I<sub>max</sub>: 10kA
- U<sub>c</sub>: 12/24/220 V

### การติดตั้ง Surge Protector (เกร็ดความรู้)

อุปกรณ์ป้องกันไฟกระชากแรงดันสูงชั่วขณะ สามารถนำไปติดตั้งในจุดต่างๆ ได้ตามลักษณะการใช้งาน โดยจัดแบ่งออกเป็น 3 ลำดับชั้น (Category) ดังนี้

1. Category A ติดตั้งอุปกรณ์ป้องกันไฟกระชากแรงดันสูงชั่วขณะใกล้กับชั้นส่วนของอุปกรณ์ไฟฟ้าที่มีความไว ต่อคุณภาพไฟฟ้าที่ต้องการป้องกัน เพื่อป้องกันชั้นส่วนนั้นๆ โดยเฉพาะ เช่น คอมพิวเตอร์, เครื่องชั่ง, เครื่องวัด, อุปกรณ์ควบคุมการประมวลผล และแหล่งจ่ายพลังงานไฟฟ้า DC ฯลฯ
2. Category B ติดตั้งอุปกรณ์ป้องกันไฟกระชากแรงดันสูงชั่วขณะที่แผงวงจรควบคุมการจ่าย (Distribution panel board) และแผงสวิตซ์ไฟฟ้า (Switchboard) การติดตั้งอุปกรณ์ฯ ที่จุดนี้จะช่วยป้องกันแรงดันไฟฟ้าสูงชั่วขณะจากภายนอก รวมถึงแรงดันไฟฟ้าที่มีการเปลี่ยนแปลงสภาวะตลอดเวลา โดยเฉพาะอย่างยิ่งหากเป็นอุปกรณ์ไฟฟ้าที่มีความไวต่อคุณภาพไฟฟ้าหรือรับพลังงานไฟฟ้าที่จ่ายจากสถานีไฟฟ้าย่อย
3. Category C ติดตั้งอุปกรณ์ป้องกันไฟกระชากแรงดันสูงชั่วขณะที่หน่วยจ่ายพลังงานไฟฟ้าขาเข้า เพื่อเป็นการป้องกันความเสียหายที่เกิดจากความผิดปกติของพลังงานไฟฟ้า การติดตั้งอุปกรณ์ฯ ที่จุดนี้จะช่วยป้องกันกรณีเกิดฟ้าผ่าซึ่งเข้ามาภายในอาคารโดยผ่านทางสายไฟ



# Standard

## Factory Standard



ISO9001 คือ ระบบการจัดการด้านคุณภาพ ISO 9001 ถูกพัฒนาขึ้นเป็นระบบมาตรฐานสากลเพื่อที่จะทำให้มั่นใจได้ว่าผู้ผลิตหรือผู้ให้บริการได้จัดตั้งและรักษาระบบการจัดการด้านคุณภาพที่เป็นมาตรฐานเดียวกัน โดยมีจุดประสงค์ที่จะตอบสนองความต้องการของลูกค้าให้ดียิ่งขึ้น โดยมาตรฐานนี้เกี่ยวกับ การออกแบบ การพัฒนา การผลิต และการให้บริการ ซึ่งสามารถใช้ได้กับทุกประเภทธุรกิจในทุกอุตสาหกรรม



ISO 14001 คือ มาตรฐานระบบการจัดการสิ่งแวดล้อม (Environmental management System) ซึ่งเป็นส่วนหนึ่งของมาตรฐานการจัดการสิ่งแวดล้อม ISO 14000 ที่ใช้เป็นแนวทางให้องค์กรหรือหน่วยงานสามารถจัดระบบ การจัดการของตนเพื่อให้บรรลุนโยบายด้านสิ่งแวดล้อมที่กำหนดไว้ ดังนั้นระบบการจัดการสิ่งแวดล้อมจึงเป็นระบบที่มีโครงสร้างหน้าที่ ความรับผิดชอบที่ชัดเจน มีวิธีการ กระบวนการและทรัพยากรอย่างเพียงพอในการดำเนินการ ภายใต้หลักเกณฑ์ คือ การวางแผน (Planning) การนำแผนไปปฏิบัติ (Doing) การตรวจสอบ (Checking) และการ ทบทวน (Action)



OHSAS 18001 ถูกพัฒนาขึ้นเพื่อรองรับความต้องการของอุตสาหกรรมให้เป็นมาตรฐานระบบจัดการสุขภาพและความปลอดภัยที่เชื่อถือได้ ซึ่งสามารถประเมินและรับรองโดยหน่วยงานภายนอก สามารถประยุกต์ใช้ได้กับทุกองค์กร ไม่ว่าจะมีความหมายใดหรือตั้งอยู่ ณ ที่ใดก็ตามการรับรอง OHSAS 18001 ทำให้ผู้ถือผลประโยชน์ร่วมของคุณทราบว่าคุณมั่นใจว่าองค์กรมีความสามารถที่จะปฏิบัติตามข้อกำหนดด้านสุขภาพและความปลอดภัย โดยไม่เพียงแต่จะเน้นย้ำความมุ่งมั่นในการปรับใช้ รักษา และปรับปรุงนโยบายด้านสุขภาพและความปลอดภัยเท่านั้น แต่ยังจะช่วยให้องค์กรของคุณมีข้อได้เปรียบในการแข่งขันอีกด้วย

## Equipment Standard



RoHS ย่อมาจาก Restriction of Hazardous Substances เป็นข้อกำหนดที่ 2002/95/EC ของสหภาพยุโรป (EU) ซึ่งเป็นมาตรฐานเพื่อสิ่งแวดล้อม ว่าด้วยเรื่องของการใช้สารที่เป็นอันตรายในอุปกรณ์เครื่องใช้ไฟฟ้าและอิเล็กทรอนิกส์ ซึ่งหมายความรวมถึงเครื่องใช้ทุกชนิด ที่ต้องอาศัยไฟฟ้าในการทำงาน เช่น โทรทัศน์ เตารีด ไมโครเวฟ วิทยุ เป็นต้น ซึ่งหมายความว่า ชิ้นส่วนทุกอย่างที่ประกอบเป็นเครื่องใช้ไฟฟ้านั้นตั้งแต่แผงวงจร ไปจนถึงสายไฟ จะต้องผ่านตามข้อกำหนดดังกล่าว ซึ่งเริ่มมีผลบังคับใช้ตั้งแต่เดือนกรกฎาคม ปี2006 แต่ในประเทศอื่น ๆ เช่น สหรัฐอเมริกา ญี่ปุ่น จีน เกาหลี ก็เริ่มที่จะกำหนดข้อบังคับในลักษณะนี้เช่นกัน ในอนาคต ข้อกำหนดนี้ก็จะแผ่ขยายครอบคลุมไปทั่วโลก



FCC ย่อมาจาก Federal Communications Commission (คณะกรรมการกลางกำกับดูแลกิจการสื่อสาร) องค์กรนี้เป็นตัวแทนรัฐบาลสหรัฐฯ ที่วางระเบียบให้แก่อุปกรณ์ประเภทวิทยุ โทรทัศน์ ผู้ให้บริการการสื่อสารระหว่างรัฐและงานให้บริการระหว่างประเทศที่อยู่ในสหรัฐฯ รวมทั้งคอมพิวเตอร์ที่ผลิตสัญญาณความถี่วิทยุ ซึ่งจะประกอบด้วยการส่งกระจายทางธุรกิจ อุปกรณ์คอมพิวเตอร์ต้องได้รับการรับรองจาก FCC ก่อนที่จะนำไปขายในสหรัฐฯ เพื่อให้ตรงกับข้อกำหนดกฎหมายเกี่ยวกับการเป็นตัวแทนและการกระจายคลื่นวิทยุ FCC จะแบ่งเครื่องคอมพิวเตอร์เป็น 2 ประเภท คือ Class A (ใช้ในงานอุตสาหกรรมหรือด้านธุรกิจ) และ Class B (ใช้งานในบ้าน)



UL คือการสนับสนุนให้มีความปลอดภัยและสภาพแวดล้อมในการทำงานที่ปลอดภัยโดยการใช้วิทยาศาสตร์ด้านความปลอดภัยและวิศวกรรมเกี่ยวกับความปลอดภัย ซึ่งครอบคลุม ผลิตภัณฑ์ เกี่ยวกับอุปกรณ์ไฟฟ้า เครื่องมือทางการแพทย์ เครื่องมือป้องกันอัคคีภัย ชิ้นส่วนอิเล็กทรอนิกส์ ยาง สายไฟฟ้า พลาสติก



CE เป็นเครื่องหมายที่แสดงการรับรองจากผู้ผลิต (Manufacturer's Declaration) ว่าสินค้าชิ้นนั้นมีคุณสมบัติตามข้อกำหนดด้านสุขภาพ ความปลอดภัย และการคุ้มครองสิ่งแวดล้อม ตามกฎหมายและกฎระเบียบที่เกี่ยวข้องของสหภาพยุโรป การมีเครื่องหมาย CE กำกับบนสินค้าจะทำให้สินค้าชิ้นนั้นสามารถวางจำหน่าย และสามารถเคลื่อนย้ายได้อย่างเสรีในเขตเศรษฐกิจยุโรป หรือ European Economic Area (EEA)



# Standard



## INTERNATIONAL STANDARD IEC

International Electrotechnical Commission (IEC) เป็นองค์กรระดับโลกสำหรับการสร้างมาตรฐาน ประกอบด้วย คณะกรรมการ Electrotechnical แห่งชาติทั้งหมด (IEC National Committees) วัตถุประสงค์ของ IEC คือการส่งเสริมความร่วมมือระหว่างประเทศสำหรับข้อมูลทั้งหมดที่เกี่ยวข้องกับการสร้างมาตรฐาน ในสาขาไฟฟ้าและอิเล็กทรอนิกส์

## IEC 60794-x-x series

- Tensile test  
IEC 60794-1-2-E1A
- Crush test  
IEC 60794-1-2-E3
- Impact test  
IEC 60794-1-2-E4
- Torsion test  
IEC 60794-1-2-E7
- Repeated bending  
IEC 60794-1-2-E6
- Temperature cycling test  
IEC 60794-1-2-F1
- Water penetration test  
IEC 60794-1-2-E5
- Drip test  
IEC 60794-1-2-E14

## OES004-045-02

OES004-045-02 มาตรฐานการพาดผ่านสายเคเบิลแบบแขวน ADSS จากบริษัท TOT



มอก. 2166

มอก. 2166 เคเบิลเส้นใยนำแสงเคเบิลภายนอกอาคาร ข้อกำหนดคุณลักษณะเป็นรายการกลุ่ม สำหรับเคเบิลเส้นใยนำแสงโทรคมนาคมแขวนในอากาศรับน้ำหนักตัวเองได้



มอก. 2165

มอก. 2165 เคเบิลเส้นใยนำแสง เคเบิลภายนอกอาคาร ข้อกำหนดคุณลักษณะเป็นรายการกลุ่ม สำหรับเคเบิลเส้นใยนำแสงโทรคมนาคม ชนิดติดตั้งในท่อร้อยสาย ฝังดินโดยตรงและแขวนในอากาศ โดยใช้ลวดพัน

## EIA/TIA

EIA/TIA สมาคมอุตสาหกรรมอิเล็กทรอนิกส์ หรือ EIA (Electronics Industries Association) และสมาคมโทรคมนาคม หรือ TIA (Telecommunication Industries Association)

## ISO/IEC 11801 : 2002

ISO/IEC 11801 : 2002 มาตรฐานสากล ISO / IEC 11801 สายเคเบิลทั่วไปสำหรับสถานที่ของ ลูกค้าระบบการเดินสายโทรคมนาคมทั่วไป (โครงสร้างสาย) ที่เหมาะสำหรับการใช้งานที่หลากหลาย (โทรศัพท์อะนาล็อกและ ISDN มาตรฐานการสื่อสารข้อมูลต่างๆระบบควบคุมอาคารโรงงาน ระบบอัตโนมัติ) มั่นครอบคลุมทั้งสายทองแดงสมดุลและสายเคเบิลใยแก้วนำแสง

## Telcordia (Bellcore)

Telcordia (Bellcore) ข้อกำหนดทั่วไปสำหรับการทดสอบสายเคเบิลใยแก้วนำแสงและใยแก้วนำแสง



ANSI/ICEA 640 สมาคมวิศวกรเคเบิลฉนวน (ICEA) ได้เผยแพร่มาตรฐานสายเคเบิลใยแก้วนำแสงใหม่ สองมาตรฐาน : ANSI / ICEA S-87-640-2006, “ ICEA มาตรฐานสำหรับสายเคเบิลใยแก้วนำแสงสื่อสาร ภายนอกโรงงาน” และ ICEA S-112-718-2006 , “ ICEA มาตรฐานสำหรับสายเคเบิลใยแก้วนำแสงสำหรับการจัดวางในสภาพแวดล้อมที่มีท่อระบายน้ำ” อดีตคือการแก้ไขมาตรฐานแห่งชาติสหรัฐอเมริกาที่มีอยู่ในขณะนั้น เป็นเรื่องใหม่



ITU-T G.652D (Singlemode) มาตรฐานที่กำหนดวิธีการทำงานของเครือข่ายโทรคมนาคม และการทำงานร่วมกัน ลักษณะเฉพาะของไฟเบอร์ออปติก แบบ Single mode และ สายไฟเบอร์ออปติกที่มีค่า ผิดเพี้ยนของสัญญาณ เป็น 0 ใน ความยาวคลื่น 1310 nm แต่ยังสามารถใช้ในความยาวคลื่นที่ 1550 nm ได้ด้วย

ITU-T G.657 มาตรฐานสายเคเบิลออปติกแบบแขวน, อาคาร, บ้าน, Fttx ,ถูกออกแบบมาให้เข้ากันได้กับเส้นใย G.652 แต่มีความไวต่อการโค้งน้อยกว่าซึ่งหมายความว่า จะลดระดับการลดทอนเนื่องจากการโค้งงอ ไฟเบอร์ G.657 แบ่งออกเป็นสองส่วน: หมวด A สำหรับการเข้าถึงเครือข่ายและหมวด B สำหรับจุดสิ้นสุดของเครือข่ายการเข้าถึง ในสภาพแวดล้อมที่อุดมด้วยการติดตั้ง แต่ละหมวดหมู่ (A และ B) แบ่งออกเป็นสองประเภทย่อย: G.657.A1 และ G.657.A2, G.657.B2 และ G.657.B3 เราสามารถเห็นรัศมีการโค้งของเส้นใย G.652 และเส้นใย G.657 ที่แตกต่างกัน

# Standard

<b>EIA/TIA568</b>	EIA/TIA568 ซึ่งเป็นมาตรฐานที่ใช้ในการผลิต UTP โดยมาตรฐานนี้ได้แบ่งประเภทของสายออกเป็นหลายประเภท โดยแต่ละประเภทจะเรียกว่า Category N โดย N คือหมายเลขที่บอกประเภท ส่วนสถาบันมาตรฐานนานาชาติ (International Organization for Standardization) ได้กำหนดมาตรฐานนี้เช่นกันโดยจะเรียกสายแต่ละประเภทเป็น Class A-F คุณสมบัติโดยทั่วไปของสายแต่ละประเภทเป็นดังนี้
<b>Category1/Class A</b>	Category1/Class A เป็นสายที่ใช้ได้กับระบบโทรศัพท์อย่างเดียวยโดยสายนี้ไม่สามารถใช้ในการส่งข้อมูลแบบดิจิทัลได้สายโทรศัพท์ที่ใช้ก่อนปี 1983 จะเป็นสายแบบ Cat 1
<b>Category2/Class B</b>	Category2/Class B เป็นสายที่รองรับแบนด์วิธได้ถึง 4 MHz ซึ่งทำให้สามารถส่งข้อมูลแบบดิจิทัลได้ถึง 4 Mbps ซึ่งประกอบด้วยสายคู่เกลียวบิดอยู่ 4 คู่
<b>Category3/Class C</b>	Category3/Class C เป็นสายที่สามารถส่งข้อมูลได้ถึง 16 Mbps และมีสายเกลียวบิดอยู่ 4 คู่
<b>Category4</b>	Category4 ส่งข้อมูลได้ถึง 20 Mbps และมีสายคู่เกลียวบิดอยู่ 4 คู่
<b>Category5/Class D</b>	Category5/Class D ส่งข้อมูลได้ถึง 100 Mbps โดยใช้ 2 คู่สายและรับส่งข้อมูลได้ถึง 1000 Mbps เมื่อใช้ 4 คู่
<b>Category5Enhanced(5se)</b>	Category5Enhanced(5e) เช่นเดียวกับ Cat 5 แต่มีคุณภาพของสายที่ดีกว่าเพื่อรองรับการส่งข้อมูลแบบ ฟลูตแพล็กที่ 1000 Mbps ซึ่งใช้ 4 คู่สาย
<b>Category6/Class E</b>	Category6/Class E รองรับแบนวิธได้ถึง 250 MHz
<b>Category7/Class F</b>	Category7/Class F รองรับแบนวิธได้ถึง 600 MHz และกำลังอยู่ระหว่างการวิจัย
<b>ANSI/TIA/EIA-568-A (TIA/EIA-568-A/B)</b>	มาตรฐานการเรียงสีสายทองแดงนำสัญญาณของ UTP
<b>ISO/IEC 11801:2002 Class E</b>	<p>มาตรฐานสากล ISO / IEC 11801 (เทคโนโลยีสารสนเทศ - สายเคเบิลทั่วไป) เหมาะสมกับสถานที่ของลูกค้ำาระบบการเดินสายโทรคมนาคมทั่วไป (โครงสร้างสาย) ที่เหมาะสำหรับการใช้งานที่หลากหลาย (โทรศัพท์อะนาล็อกและ ISDN มาตรฐานการสื่อสารข้อมูลต่างๆระบบควบคุมอาคารโรงงาน ระบบอัตโนมัติ) มั่นคงครอบคลุมทั้งสายทองแดงสมดุลและสายเคเบิลใยแก้วนำแสง</p>
<b>EN50173</b>	EN50173 CAT 6 test สายเคเบิลทั่วไปเป็นของยุโรป CAT 6
<b>ICEA S-102-700</b>	ICEA S-102-700 Cat 6 หมวดที่ 6 สายเคเบิลภายในอาคารที่ไม่หุ้มฉนวนแบบแยกทีละคู่ (มีหรือไม่มีโลโดยรวม) สำหรับใช้ในระบบการสื่อสารสายไฟข้อกำหนดทางเทคนิค
<b>EN50288-6-1 NEMA WC 66</b>	มาตรฐานสำหรับหมวดที่ 6 และ 6A, 100 โอห์ม, คู่ที่ไม่ได้รับการยกเว้น, สายเคเบิลภายในอาคาร (มีหรือไม่มีแผ่นกระเบื้องโดยรวม) เพื่อใช้ในระบบสายสื่อสาร LAN
<b>ETL Intertek</b>	คือบริษัทชั้นนำด้านการทดสอบและมีห้องปฏิบัติการสำหรับทดสอบผลิตภัณฑ์ที่เป็นมาตรฐานสากลยอมรับในระดับนานาชาติและระดับโลก ด้วยประสบการณ์อันยาวนานกว่า 130 ปี โดยเน้นการทดสอบทางด้านประสิทธิภาพการทำงานและด้านความปลอดภัยของสินค้าต่างๆ เครื่องหมาย ETL เป็นเครื่องบ่งบอกว่า เครื่องใช้ไฟฟ้าและอิเล็กทรอนิกส์นั้นได้เป็นไปตามมาตรฐานบังคับทางด้านไฟฟ้าที่เกี่ยวข้องทุกประการ

# Standard

## มาตรฐาน EIA/TIA-942 Uptime Institute SAS-70 และ SSAE-16

ซึ่งเป็นมาตรฐาน การเดินสายสัญญาณ และออกแบบติดตั้ง Data Center รวมทั้งการ Audit ความปลอดภัย

### มาตรฐานอย่างเป็นทางการสำหรับชั้นวางขนาด 19 นิ้ว (482.6 มม.)

มีให้บริการจากรายการต่อไปนี้

- กลุ่มอุตสาหกรรมอิเล็กทรอนิกส์ EIA-310-D, ตู้, ชั้นวาง, แผงและอุปกรณ์ที่เกี่ยวข้อง, ลงวันที่กันยายน 1992 (มาตรฐานล่าสุดตอนนี้ REVE 1996)
- สมาคมผู้บริโภคเครื่องใช้ไฟฟ้า CEA-310-E ข้อกำหนดการออกแบบสำหรับตู้, แผง, ชั้นวางและชั้นย่อย, ลงวันที่ 14 ธันวาคม 2548
- International Electrotechnical Commission - มีเอกสารหลายฉบับให้บริการในเวอร์ชันภาษาฝรั่งเศสและภาษาอังกฤษ

IEC 60297	โครงสร้างทางกลสำหรับอุปกรณ์อิเล็กทรอนิกส์ - ขนาดของโครงสร้างทางกลของซีรีส์ 482,6 มม. (19 นิ้ว)
IEC 60297-1	ถูกแทนที่โดย IEC 60297-3-100
IEC 60297-2	ถูกแทนที่โดย IEC 60297-3-100
IEC 60297-3-100	ส่วนที่ 3-100: ขนาดพื้นฐานของแผงด้านหน้า, subracks, แชสซี, ชั้นวางและตู้
IEC 60297-3-101	ส่วนที่ 3-101: subracks และหน่วยปลั๊กอินที่เกี่ยวข้อง
IEC 60297-3-102	ส่วนที่ 3-102: ที่จับหัวฉีด / แยก
IEC 60297-3-103	ส่วนที่ 3-103: คีย์พินและการจัดตำแหน่ง
IEC 60297-3-104	ส่วนที่ 3-104: ขนาดส่วนต่อประสานที่ขึ้นอยู่กับตัวเชื่อมต่อของ subracks และหน่วยปลั๊กอิน
IEC 60297-3-105	ส่วนที่ 3-105: ขนาดและลักษณะการออกแบบสำหรับโครงเครื่อง 1U
IEC 60297-4	ถูกแทนที่โดย IEC 60297-3-102
IEC 60297-5	เอกสารหลายรายการ, -100, 101, 102, ... 107, แทนที่ด้วย IEC 60297-3-101
DIN 41494	การปฏิบัติอุปกรณ์สำหรับอุปกรณ์อิเล็กทรอนิกส์ โครงสร้างทางกลของซีรีส์ 482,6 มม. (19 นิ้ว)
DIN 41494-7	ขนาดของตู้และชุดของชั้นวาง
DIN 41494-8	ส่วนประกอบที่แผงด้านหน้า เงื่อนไขการติดตั้งขนาด
DIN IEC 60297-3-100	(ดูด้านบนในส่วน IEC)

### มาตรฐาน IP หรือที่เรารู้จักได้ยกันว่า IP Rating, IP Code, IP Standard หรือ Ingress Protection Rating

คือ มาตรฐานที่บอกถึงระดับการป้องกันฝุ่นละอองและน้ำของเครื่องจักร และอุปกรณ์ไฟฟ้า

IP 23	สามารถป้องกันการสัมผัสตัวอุปกรณ์โดยไม่ตั้งใจจากรูมือหรือเครื่องมืออื่นๆ ที่มีขนาดใกล้เคียงกัน และสามารถป้องกันละอองน้ำที่ตกกระทบในแนวเฉียงรอบอุปกรณ์ได้ทำมุมสูงสุด 60 องศาจากแนวตั้งได้
IP 54	มีความสามารถที่จะป้องกันฝุ่นได้แต่อาจมีฝุ่นเล็กน้อยเล็ดลอดเข้าไปโดยฝุ่นที่เล็ดลอดเข้าไปนั้นต้องไม่มีผลใดๆต่อการทำงานของอุปกรณ์และมีความสามารถที่จะป้องกันละอองน้ำที่ตกกระทบตัวอุปกรณ์ได้จากทุกทิศทาง
IP55	มีความสามารถที่จะป้องกันฝุ่นได้แต่อาจมีฝุ่นเล็กน้อยเล็ดลอดเข้าไปโดยฝุ่นที่เล็ดลอดเข้าไปนั้นต้องไม่มีผลใดๆต่อการทำงานของอุปกรณ์และมีความสามารถที่จะป้องกันการฉีดน้ำได้ทุกทิศทาง
IP65	มีความสามารถที่จะป้องกันฝุ่นได้สมบูรณ์และมีความสามารถที่จะป้องกันน้ำจากการฉีดที่ตัวอุปกรณ์ได้จากทุกทิศทาง

# Standard

---

## QSFP types

Quad Small Form-factor Pluggable (QSFP) รับส่งสัญญาณมีหลากหลายประเภทของเครื่องส่งสัญญาณและตัวรับสัญญาณให้ผู้ใช้สามารถเลือกเครื่องรับส่งสัญญาณที่เหมาะสมสำหรับแต่ละลิงก์

### 4 Gbit / s QSFP

เอกสาร QSFP ตั้งเดิมระบุสี่ช่องสัญญาณที่มี Gigabit Ethernet, 4GFC (FiberChannel) หรือ DDR InfiniBand

### 40 Gbit / s QSFP +

QSFP + เป็นวิวัฒนาการของ QSFP เพื่อรองรับช่อง 10 Gbit / วินาทีสี่ช่องซึ่งมี 10 Gigabit Ethernet, 10GFC FiberChannel หรือ QDR InfiniBand 4 ช่องสัญญาณสามารถรวมเข้าด้วยกันเป็น 40 Gigabit Ethernet link

### 50 Gbit / s QSFP14

มาตรฐาน QSFP14 ถูกออกแบบมาเพื่อพก FDR InfiniBand, SAS-3 [42] หรือ 16G Fibre Channel

### 100 Gbit / s QSFP28

มาตรฐาน QSFP28 ออกแบบมาเพื่อรองรับ 100 Gigabit Ethernet, EDR InfiniBand หรือ 32G Fibre Channel บางครั้งประเภทตัวรับส่งสัญญาณนี้จะเรียกว่า "QSFP100" หรือ "100G QSFP" เพื่อความเรียบง่าย

### 200 Gbit / s QSFP56

QSFP56 ออกแบบมาเพื่อรองรับ 200 Gigabit Ethernet, HDR InfiniBand หรือ 64G Fibre Channel การปรับปรุงที่ใหญ่ที่สุดคือ QSFP56 ใช้การเข้ารหัส PAM-4 แทน NRZ เมื่อวันที่เมษายน 2562 มาตรฐานใหม่นี้ยังไม่ได้รับการตีพิมพ์ แต่ที่อยู่แล้วส่งสัญญาณ มันใช้คุณสมบัติทางกายภาพเช่นเดียวกับ QSFP28 (SFF-8665) พร้อมรายละเอียดทางไฟฟ้าจาก SFF-8024 และการแก้ไขที่ยังไม่ได้เผยแพร่ 2.10 ของ SFF-8636 บางครั้งประเภทตัวรับส่งสัญญาณนี้เรียกว่า "200G QSFP" เพื่อความเรียบง่าย

# 1 Gbit / s SFP

---

1 Gbit / s

มัลติโหมตไฟเบอร์ตัวเชื่อมต่อ LC พร้อมคั่นโยกแยกสีดำหรือสีเบจ SX - 850 nm สูงสุด 550 เมตรที่ 1.25 Gbit / s (กิกะบิตอีเธอร์เน็ต) แอปพลิเคชัน SFP หลายโหมตอื่น ๆ รองรับอัตราที่สูงขึ้นในระยะทางที่สั้นกว่า

1.25 Gbit / s

มัลติโหมตไฟเบอร์, ตัวเชื่อมต่อ LC, สิ้นโยกที่ไม่ได้มาตรฐาน SX + / MX / LSX (ขึ้นอยู่กับชื่อผู้ผลิต) - 1310 nm เป็นระยะทางสูงสุด 2 กม. เข้ากันไม่ได้กับ SX หรือ 100BASE-FX ขึ้นอยู่กับ LX แต่ได้รับการออกแบบให้ทำงานกับไฟเบอร์แบบหลายโหมตโดยใช้สายเคเบิลสำหรับแก้ไขโหมตมาตรฐานแบบมาตรฐานแทนที่จะใช้สายเคเบิลแบบปรับอากาศเพื่อปรับตัว LX ให้เข้ากับโหมตหลายโหมต

10 Gbit / s SFP +

ตัวรับส่งสัญญาณ 10 Gigabit Ethernet XFP และตัวรับส่งสัญญาณ SFP + เคียงข้างกัน แบบฟอร์มแพ็คเกจขนาดเล็กที่ปรับได้ (SFP +) เป็นรุ่นปรับปรุงของ SFP ที่รองรับอัตราข้อมูลสูงสุด 16 Gbit / s ข้อมูลจำเพาะของ SFP + ได้รับการเผยแพร่ครั้งแรกเมื่อวันที่ 9 พฤษภาคม 2549 และรุ่น 4.1 ที่เผยแพร่เมื่อวันที่ 6 กรกฎาคม 2552 SFP + รองรับ 8 Gbit / s Fibre Channel, 10 Gigabit Ethernet และ Optical Network Network OTU2 มาตรฐาน OTU2 เป็นรูปแบบอุตสาหกรรมยอนิยที่ได้รับการสนับสนุนจากผู้จำหน่ายส่วนประกอบเครือข่ายหลายราย แม้ว่ามาตรฐาน SFP + ไม่ได้รวมการกล่าวถึง 16 Gbit / s Fibre Channel แต่ก็สามารถใช้งานได้ที่ความเร็วนี้



# Standard

## มาตรฐาน 80+ uu Power Supply Unit (PSU)

ประสิทธิภาพการทำงานของ PSU (การแปลงไฟจาก AC สู่ DC) ระหว่าง พลังงานขาเข้าและขาออกที่ให้ประสิทธิภาพได้เกินกว่า 80% หรือมีการสูญเสียไม่เกิน 20% ” ซึ่งในทางวิศวกรรมนั้น ” ประสิทธิภาพใดๆก็ตามจะต้องไม่เกิน 1 หรือ 100% “ ของผลต่างระหว่างด้าน Input (ขาเข้า) และ Output (ขาออก)

โดยมีสมการดังนี้

$$\text{efficiency} = \text{Output/Input (ขาออกหารด้วยขาเข้า)}$$

# 80 Plus Standard



80 Plus (ธรรมดา) ก็คือ PSU ที่มีประสิทธิภาพในการทำงานที่โหลดตลอดทั้งสามช่วงคือ 20%, 50%, 100% Load ได้ 0.8 (80% efficiency) พอดี และจะทดสอบกับ PSU ที่ใช้ไฟ AC ในช่วง 110V เท่านั้น



80 Plus Broze (ชั้นทองแดง) ก็คือ PSU ที่มีประสิทธิภาพในการทำงานที่โหลดในช่วง 20% จากความสามารถทั้งหมดของ PSU ได้ในระดับเกินกว่า 0.81 และที่ภาระ 50% มีประสิทธิภาพเกินกว่า 0.85 และที่โหลดเต็ม 100% จะต้องมีประสิทธิภาพเกินกว่า 0.81 สำหรับ PSU ที่ใช้ไฟด้าน AC 220V จึงจะได้การกรันตีมาในระดับนี้



80 Plus Silver (ชั้นเงิน) ก็คือ PSU ที่มีประสิทธิภาพในการทำงานที่โหลดในช่วง 20% จากความสามารถทั้งหมดของ PSU ได้ในระดับเกินกว่า 0.85 และที่ภาระ 50% มีประสิทธิภาพเกินกว่า 0.89 และที่โหลดเต็ม 100% จะต้องมีประสิทธิภาพเกินกว่า 0.85 สำหรับ PSU ที่ใช้ไฟด้าน AC 220V จึงจะได้การกรันตีมาในระดับนี้



80 Plus Gold (ชั้นทอง) ก็คือ PSU ที่มีประสิทธิภาพในการทำงานที่โหลดในช่วง 20% จากความสามารถทั้งหมดของ PSU ได้ในระดับเกินกว่า 0.88 และที่ภาระ 50% มีประสิทธิภาพเกินกว่า 0.92 และที่โหลดเต็ม 100% จะต้องมีประสิทธิภาพเกินกว่า 0.88 สำหรับ PSU ที่ใช้ไฟด้าน AC 220V จึงจะได้การกรันตีมาในระดับนี้



























80 Plus Platinum (ชั้นแพลททินัม) ก็คือ PSU ที่มีประสิทธิภาพในการทำงานที่โหลดในช่วง 20% จากความสามารถทั้งหมดของ PSU ได้ในระดับเกินกว่า 0.9 และที่ภาระ 50% มีประสิทธิภาพเกินกว่า 0.94 และที่โหลดเต็ม 100% จะต้องมีประสิทธิภาพเกินกว่า 0.91 สำหรับ PSU ที่ใช้ไฟด้าน AC 220V จึงจะได้การกรันตีมาในระดับนี้



80 Plus Titanium (ชั้นไทเทเนียม) ก็คือ PSU ที่มีประสิทธิภาพในการทำงานที่โหลดในช่วง 20% จากความสามารถทั้งหมดของ PSU ได้ในระดับเกินกว่า 0.94 และที่ภาระ 50% มีประสิทธิภาพเกินกว่า 0.96 และที่โหลดเต็ม 100% จะต้องมีประสิทธิภาพเกินกว่า 0.91 ซึ่งในระดับสูงสุดนี้ยังมีการวัดการจ่ายพลังงานที่ภาระช่วงต่ำๆเพียง 10% ด้วยซึ่งจะต้องมีประสิทธิภาพได้เกินกว่า 0.9 ซึ่งถือว่าไม่ใช่เรื่องง่ายๆ เลยสำหรับการทำงานในช่วงนี้ สำหรับ PSU ที่ใช้ไฟด้าน AC 220V จึงจะได้การกรันตีมาในระดับนี้

# WARRANTY

 <b>30</b> WARRANTY Year	<b>Fiber optic</b>	 <b>1</b> WARRANTY Year	<b>Fiber optic Accessories</b>
 <b>30</b> WARRANTY Year	<b>FTTH (Fiber Optic To The Home)</b>	 <b>1</b> WARRANTY Year	<b>FTTH Accessories</b>
 <b>30</b> WARRANTY Year	<b>MPO Trunk Cable</b>	 <b>1</b> WARRANTY Year	<b>MPO Solution for Data Center Accessories</b>
 <b>30</b> WARRANTY Year	<b>Air Blown Fiber</b>	 <b>1</b> WARRANTY Year	<b>Air Blown Fiber Accessories</b>
 <b>30</b> WARRANTY Year	<b>RG Cable</b>	 <b>1</b> WARRANTY Year	<b>RG Cable Accessories</b>
 <b>3</b> WARRANTY Year	<b>HDMI Cable</b>	 <b>3</b> WARRANTY Year	<b>HDMI-VGA-DVI</b>
 <b>30</b> WARRANTY Year	<b>UTP Cable</b>	 <b>3</b> WARRANTY Year	<b>UTP Accessorie</b>
 <b>30</b> WARRANTY Year	<b>Rack And Cabinet</b>	 <b>1</b> WARRANTY Year	<b>Rack And Cabinet Accessories</b>
 <b>3</b> WARRANTY Year	<b>POE Switch</b>	 <b>3</b> WARRANTY Year	<b>Media Converter / SFP</b>
 <b>5</b> WARRANTY Year	<b>Industrial switch</b>	 <b>3</b> WARRANTY Year	<b>Surge Protection</b>
 <b>2</b> WARRANTY Year	<b>Power Supply</b>	 <b>2</b> WARRANTY Year	<b>Fiber Tool and Tester</b>
 <b>1</b> WARRANTY Year	<b>OLT-ONU</b>	 <b>15</b> WARRANTY Year	<b>Wire Mesh / Fiber Way</b>

## หมายเหตุ

การรับประกันสินค้าทุกรายการจะต้องเกิดจากความบกพร่องของตัวสินค้า เนื่องจากการใช้งานปกติ หรือ เกิดจากความผิดพลาดในการผลิต หรือ สาเหตุจากความผิดพลาดของบริษัทผู้ขาย ไม่ครอบคลุมการใช้งานผิดประเภท อุบัติเหตุ หรือ ภัยธรรมชาติต่างๆ

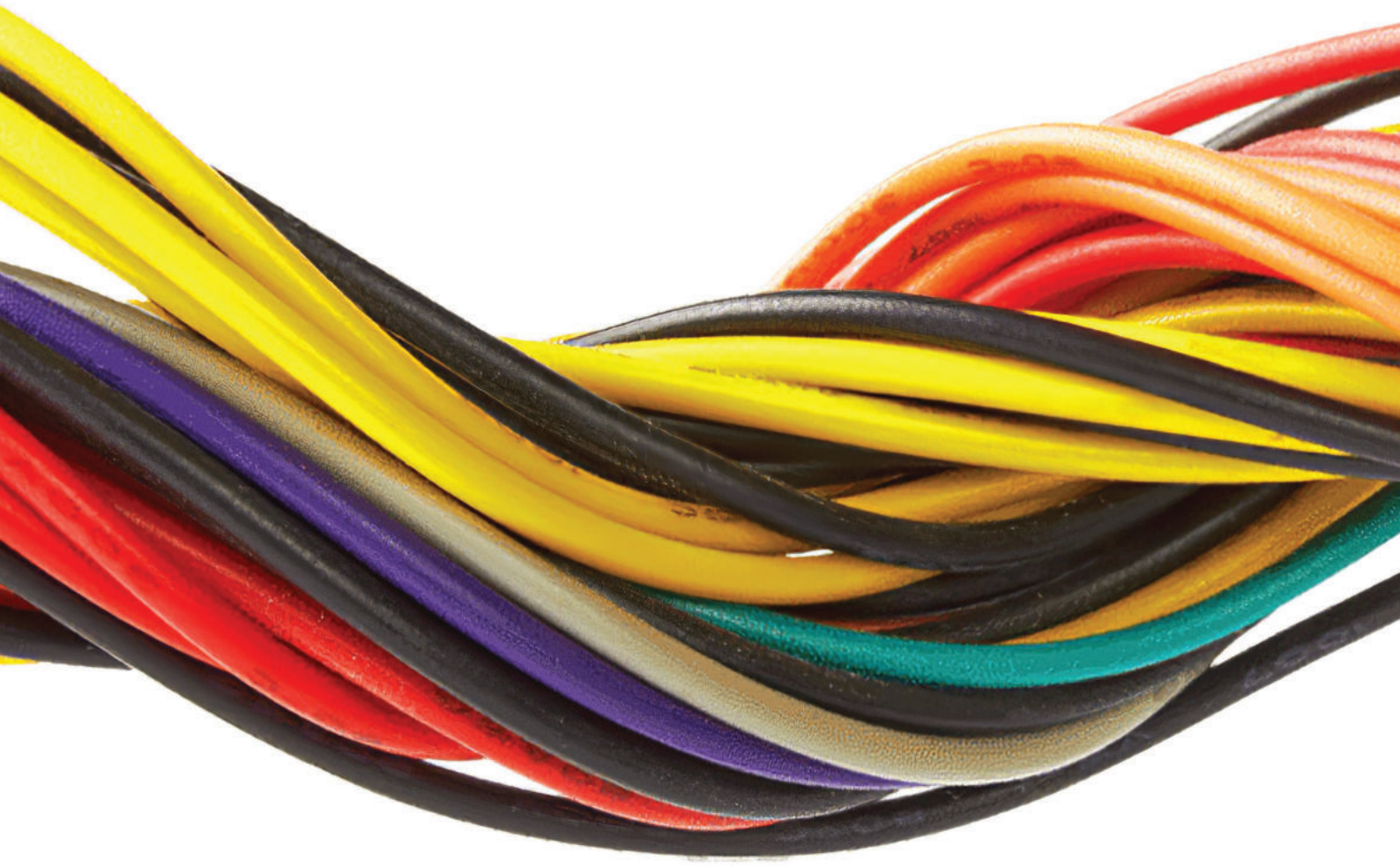

## Contact

- 📌 Facebook : Focomm Cabling
- ✉️ info@focomm-cabling.com
- 🌐 www.focomm-cabling.com
- ☎️ 02-557-6451 / 063-391-5262 Fax 02-557-6452
- 🗣️ Line ID : @focomm

Location

